

# WIREMOLD



## 861 Series Outlet Boxes for Wood & Raised Floors INSTALLATION INSTRUCTIONS

Installation Instruction No.: 1 002 968R1 – Updated November 2005

Walker® electrical systems conform to and should be properly grounded in compliance with requirements of the current National Electrical Code or codes administered by local authorities.

All electrical products may present a possible shock or fire hazard if improperly installed or used. Walker electrical products may bear the mark as UL Listed and/or Classified and should be installed in conformance with current local and/or the National Electrical Code.

**IMPORTANT: Please read all instructions before beginning.**

**Products Covered:** 861, 861QTC, 861AMDTC, 861AMDRTTC, & 861FFTC

### Applications:

This unit is for wood floor and raised floor construction with:

- 3/4" [19.1mm] subflooring with carpet and padding or
- 3/4" [19.1mm] subflooring with 1/4" underlayment and tile or linoleum floor covering.

These requirements represent the minimum floor thickness to ensure enough cross section is available for the box to lock into the subflooring.

- Suitable for use in air handling spaces in accordance with sec. 300-22(C) of the National Electrical Code.

### BOX INSTALLATION

1. Determine the floor box location. (Make sure the placement does not interfere with obstructions below such as floor joists, HVAC duct, light fixtures, etc.) Drill a hole through the flooring using a 4" [102mm] hole saw (4 1/16" [104mm] actual).
2. For a flush installation in hardwood or tile floors with the 895T or 896T series covers - cut a 4 5/16" [109mm] diameter, 1/8" [3.2mm] deep step in the final floor covering.
3. Pull the nonmetallic sheathed cable or armor clad cable up to and through the 4" [102mm] hole.

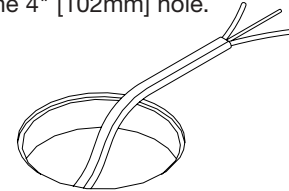
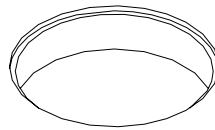
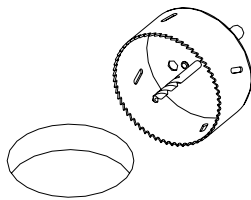

**NOTE:** For air handling spaces allowed for that application. See NEC 300-22(C). For communications applications, type CMP communication plenum cable is required in raised floor plenums when wiring methods as described in NEC article 300-22(C) are not followed.

4. Remove the appropriate 1/2" [12.7mm] trade size knockout and attach a cable connector to accommodate the wiring system being used. Attach the wiring system to the box. To access the wiring cavity, open the disposable cover cap and reseal after use to avoid debris entry.
5. Orient the box to the desired rotation and push into the hole. The box will not turn once installed so make sure the receptacle will be parallel or perpendicular with any adjacent walls.
6. Use the disposable cover as a template to trim around when installing carpet or tile.

Attach the wiring system to the box. To access the wiring cavity, open the disposable cover cap and reseal after use to avoid debris entry.

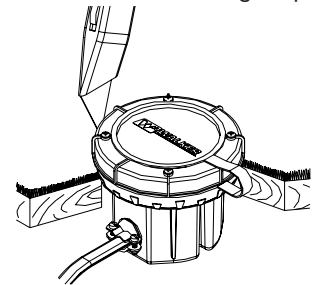
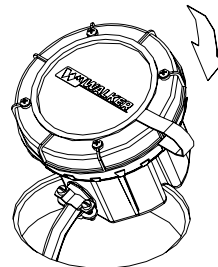
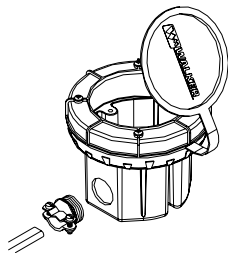

**NOTE:** Refer to carpet/tile cutout template when installing the following catalog numbers: 861QTC, 861CMDTC, 861CMDRTTC, 861FFTC.

7. When wiring the final activation, remove the disposable cover taking care not to push the box through the opening.

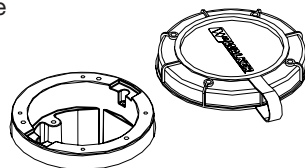

## QUAD RECEPTACLE COVER INSTALLATION: Cat No. 861QTC

1. Wire and attach the quad receptacle to the outlet box using (2) #8 x 3/4" round head screws.
2. Attach trim flange to outlet box using (4) #6 x 3/8" flat head screws.
3. Align gasket over receptacle and press bead into flange.

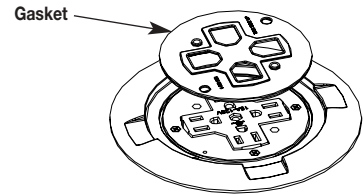
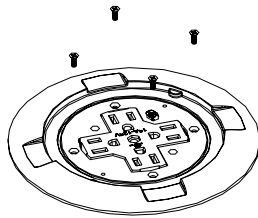
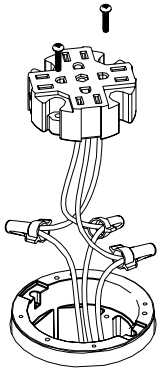

**CAUTION:** Receptacle mounting means not grounded. Grounding wire connection required. For isolated ground wiring, connect ground leads to a separate isolated ground conductor. See NEC 250-146(d).

**CAUTION:** Gasket must be set in place to provide scrub water seal.

4. Attach the slide cover with (2) #6 cover screws. Do not over tighten screws. Apply icon on receptacle slide if wired for isolated ground circuit. Push box into the hole until firmly seated against floor finish.

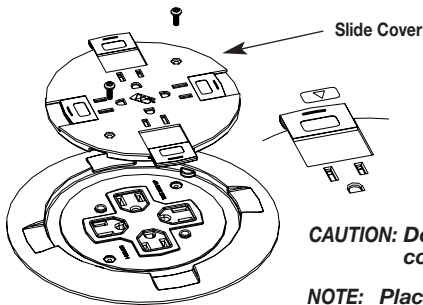

CONVENTIONAL WIRING SCHEMATIC		ISOLATED GROUND WIRING SCHEMATIC	
<b>BLACK or HOT</b> From branch circuit	<b>BLACK</b> from poke-thru receptacle	<b>BLACK or HOT</b> From branch circuit	<b>BLACK</b> from poke-thru receptacle
<b>WHITE or NEUTRAL</b> From branch circuit	<b>WHITE</b> from poke-thru receptacle	<b>WHITE or NEUTRAL</b> From branch circuit	<b>WHITE</b> from poke-thru receptacle
<b>GREEN or GROUND</b> From branch circuit	<b>GREEN</b> from poke-thru receptacle	<b>ISOLATED GROUND</b> From branch circuit	<b>GREEN</b> from poke-thru receptacle
<b>System Ground</b>			
	<b>GREEN (jumper wire)</b> from poke-thru junction box	<b>GREEN or GROUND</b> From branch circuit	<b>GREEN (jumper wire)</b> from poke-thru junction box
		<b>System Ground</b>	

**WARNING:** Ground wire from junction box must be connected to system ground.

**CAUTION:** Do not operate tile stripper or resurfacing equipment over top of cover. This may result in damage to the finish of the product.

**NOTE:** Place Orange triangle on devices that are wired for isolated ground. See NEC 250-146(D).

## FURNITURE FEED COVER INSTALLATION: Cat No. 861FFTC

1. Attach conduit flange to the outlet box using (4) #6 x 1/2" pan head screws. Push the box into the hole until firmly seated against the floor finish.
2. Remove screw plugs and install flexible conduit fittings with conduit.

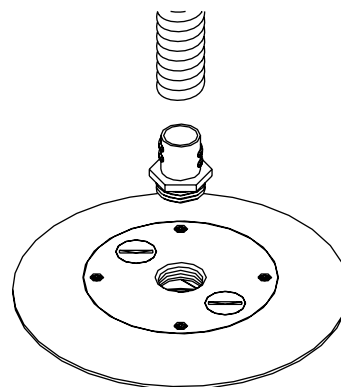
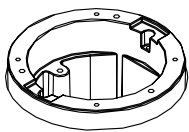
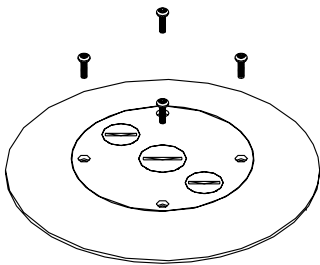

**NOTE:** Keep screw plugs for future abandonment.

**CAUTION:** Do not operate tile stripper or resurfacing equipment over top of cover. This may result in damage to the finish of the product.

# COMMUNICATIONS COVER INSTALLATION: Cat No. 861AMDTC & 861AMDR TTC

1. Attach trim flange with jacks to the outlet box using (4) #6 X 3/8" flat head screws.

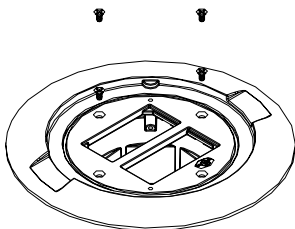

2. Wire and snap appropriate communication jacks in adapters as shown below. Insert blanking plugs or neoprene foam blocks in unused communication ports.

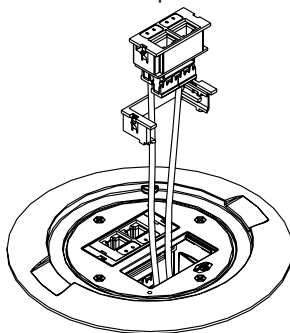

3. Wire communication jacks and snap into adapter bezel.

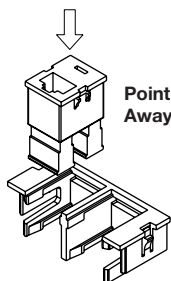

Point Keystone Tab Away From Bezel.

Ortronics TracJack Bezel and Communication Jack (TracJack Modular Inserts sold separately)

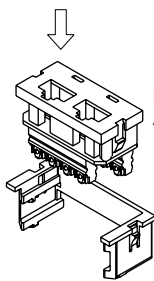

Point Keystone Tab Away From Bezel.

Ortronics Series II Bezel and Communication Jack (Series II Bezel Included; Series II Modular Inserts sold separately)

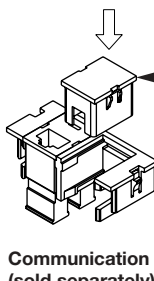

TracJack Blank (supplied)

Communication Jack (sold separately)

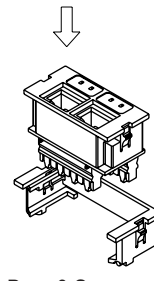

Pass & Seymour ACTIVATE Bezel and Communication Jack

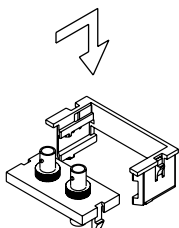

Lower Level Bezel Installation (Typical for Fiber Installations) (Fiber Jack sold separately)

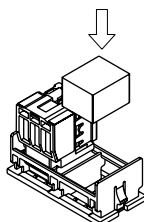

Foam Plug (supplied)

4. Align gasket over devices and press bead into flange.

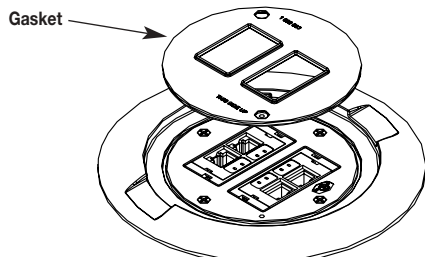

**CAUTION:** Gasket must be set in place to provide scrub water seal.

5. Install slide cover with (2) #6 cover screws. Do not over tighten screws. Complete the installation by pushing the box into the hole until firmly seated against the floor finish.

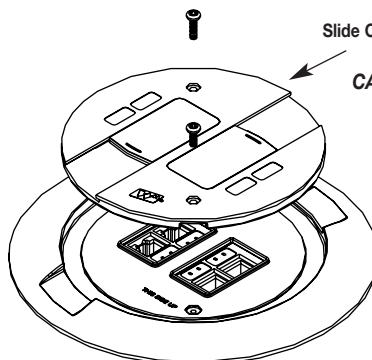

**CAUTION:** Do not operate tile stripper or resurfacing equipment over top of cover. This may result in damage to the finish of the product.

# Carpet/Tile Cutout Template

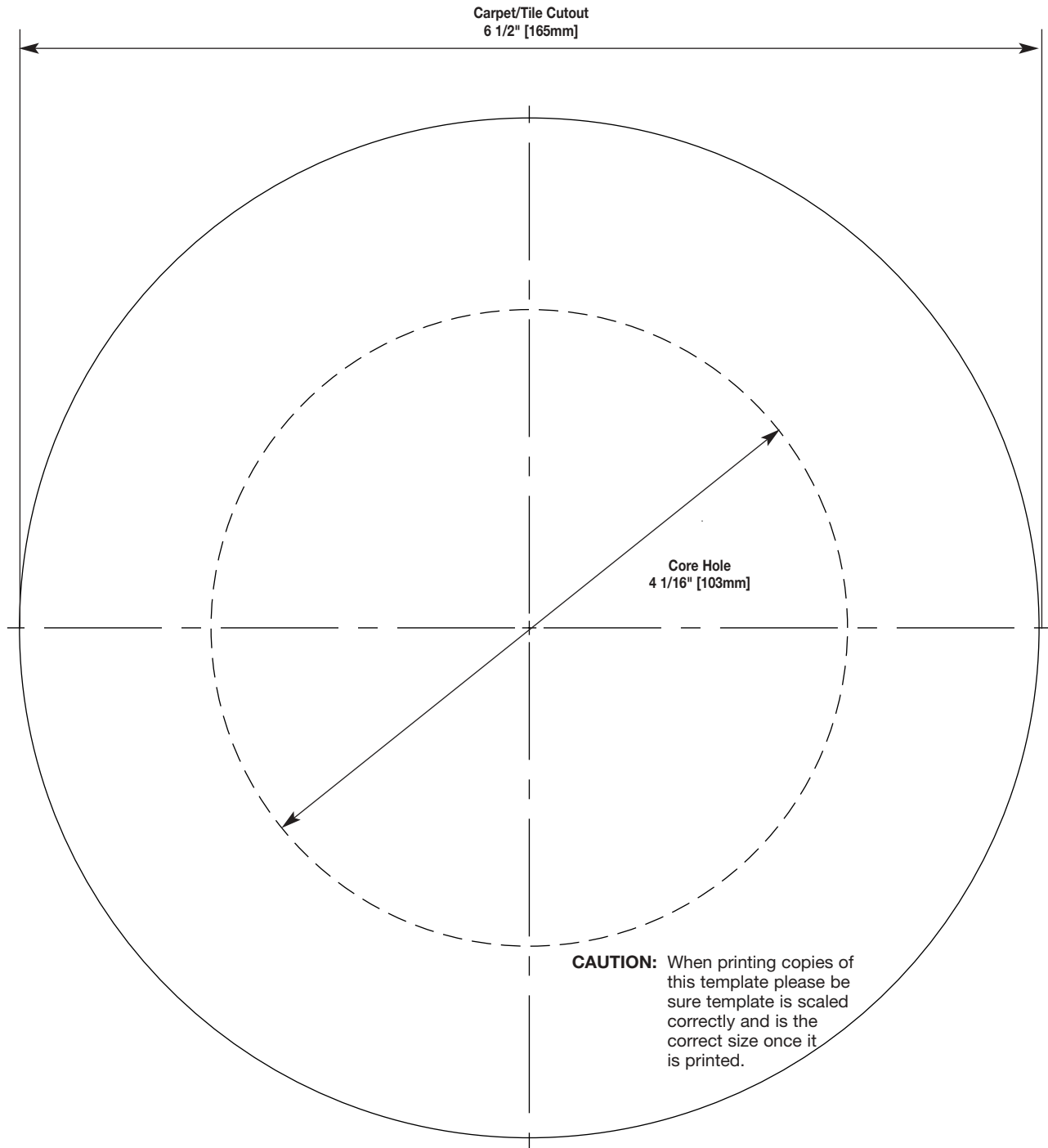

# WIREMOLD



**Wiremold / Legrand**

*U.S. and International:*

60 Woodlawn Street • West Hartford, CT 06110

1-800-621-0049 • FAX 860-232-2062 • Outside U.S. 860-233-6251

*Canada:*

570 Applewood Crescent • Vaughan, Ontario L4K 4B4

1-800-723-5175 • FAX 905-738-9721

