

4000[®] SERIES RACEWAY



Single- and Dual-Channel, Steel Raceway. Easy-to-install and ideal for basic power or communication/low voltage installations.

CODE REFERENCE

cULus Listed Raceway:
File E4376 Guide RJBT.

Fittings:
File E41751 Guide RJPR.
Meets Article 386 of NEC.
Meets Section 12-1600 of CEC.

System Layout

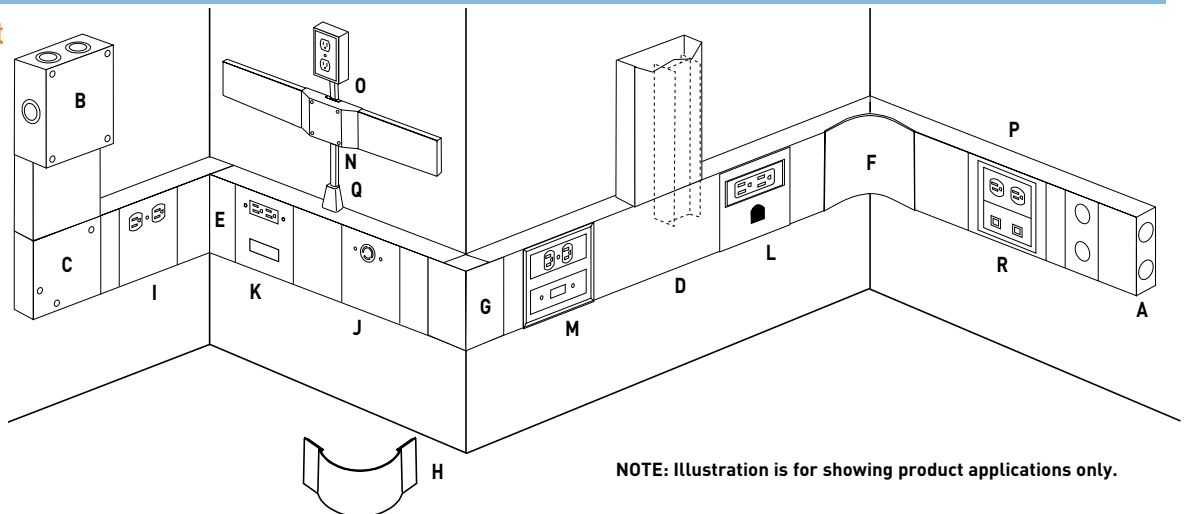

NOTE: Illustration is for showing product applications only.

KEY

- | | | | |
|---|---|--|--|
| A. 4010B Blank End Fitting | G. 4018 External Elbow | K. 4047RF Rectangular Receptacles and Modular Furniture Device Plate | N. 4075DA Bridge Fitting |
| B. 4010DFO Entrance End Fitting | H. 4018FO Radiused Full Capacity External Elbow | L. 4047RH Device Plate for Rectangular Receptacle and Mousehole | O. 500 Series Raceway |
| C. 4011 Flat Elbow | I. 4047BX Duplex Receptacle Device Plate | M. 4050 Device Mounting Plate with 5507 Series Faceplates | P. 5507D Duplex Faceplate |
| D. 4015D Divided Tee | J. 4047JX Single Receptacle & Device Plate | | Q. 5785 Combination Connector |
| E. 4017 Internal Elbow | | | R. 5507RJ Device Plate with two RJ ports |
| F. 4017FO Radiused Full Capacity Internal Elbow | | | |

COLOR OPTIONS



4000[®] Series Raceway Part Numbers with a "V" prefix have an ivory finish. Part Numbers with a "G" prefix have a gray finish.

Custom color options are also available. Consult the factory for more information.

4000[®] SERIES RACEWAY

4000 Series Raceway Ordering Information

Raceway Base

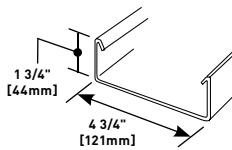
PART NUMBERS:
V4000B-10 (Ivory)

G4000B-10 (Gray)

.054" [13.7mm] galvanized steel. Packed five 10' [3m] lengths per carton. Base has two 9/32" [7.1mm] diameter KOs every 18" [457mm] throughout length. No KOs 1 1/4" [32mm] from each end.

Raceway Cover

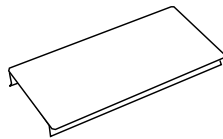
PART NUMBERS:
V4000C (Ivory)

G4000C (Gray)

.040" [1.0mm] galvanized steel. Packed ten 5' [1.5m] lengths per carton. 4000C Cover is also compatible with 6000B, 6000 Series Raceway Base.

7.5" [191mm] Precut Raceway Cover

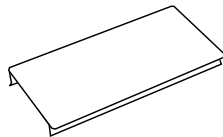
PART NUMBERS:
V4000C075 (Ivory)

G4000C075 (Gray)

Mounts devices spaced 12" [305mm] on center using 4047 Series device plates.

13.5" [343 mm] Precut Raceway Cover

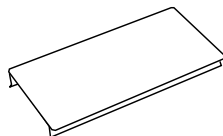
PART NUMBERS:
V4000C135 (Ivory)

G4000C135 (Gray)

Mounts devices spaced 18" [457mm] on center using 4047 Series device plates.

19.5" [495 mm] Precut Raceway Cover

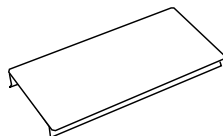
PART NUMBERS:
V4000C195 (Ivory)

G4000C195 (Gray)

Mounts devices spaced 24" [610mm] on center using 4047 Series device plates.

31.5" [800 mm] Precut Raceway Cover

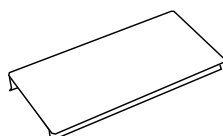
PART NUMBERS:
V4000C315 (Ivory)

G4000C315 (Gray)

Mounts devices spaced 36" [915mm] on center using 4047 Series device plates.

G4000D Divider

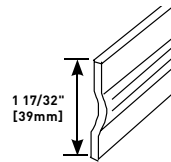

.040" [1.0mm] galvanized steel. Painted on one side only to provide compartment identification. Packed ten 5' [1.5m] lengths (50' [15.2m]) per carton.

640B Base Cutter

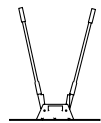

Portable cutter for 4000 Series Raceway Base. Provides clean and square end cuts.

NOTE: Not for use with stainless steel S4000 Series Raceway.

640BDK Replacement Blade Kit

Case hard steel replacement blade and die set for 640B Cutter

640C Cover Cutter

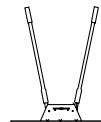

Portable cutter for 4000 and 6000 Series Raceway Cover. Provides clean and square end cuts.

NOTE: Not for use with stainless steel S4000 Series Raceway.

640CDK Replacement Blade Kit

Case hard steel replacement blade and die set for 640C Cutter.

G4000WC Wire Clip (Galvanized)



Holds conductors in place.

4001A Coupling (Galvanized)

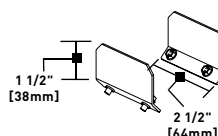

Joins lengths of 4000B Raceway Base. Sold in pairs.