

FIRE CLASSIFIED FLOOR BOXES

880MP Series Floor Boxes

Fire Classified 880MP Floor Box Ordering Information

880MPFC Fire Classified Nonmetallic Rectangular Floor Box

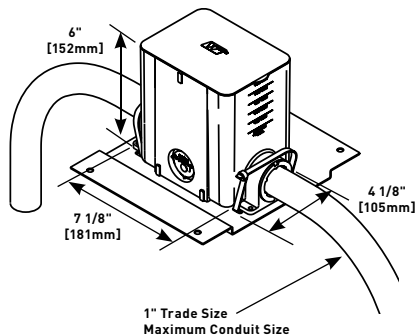

Box comes complete with reusable mudcap, insert spacer, conduit plugs and reducers. Reducers provided for reduction to 1", 3/4" and 1/2" [25mm, 19.1mm and 12.7mm] conduit. Minimum concrete depth is 3 1/2" [89mm] and maximum concrete depth is 6" [152mm]. Minimum capacity is 50 cu. in. [819ml] and maximum capacity is 100 cu. in. [1639ml]. Box dimensions are 4 1/8" W x 5 1/2" L x 6" D [105mm x 140mm x 152mm].

NOTES: Insert spacer should not be removed until after concrete pour.
880MPFC is a single-gang offering. Can not gang boxes together and maintain Fire Classification.
Floor Box spacing 2' on center and one for every 65 square feet in a span.
Maximum Copper Cross Section per Insert: Four (4) #12 AWG Type THHN Power Conductor or 48 #23 AWG (6 Cat. 6) Tele Data conductors.

880MPA Nonmetallic Floor Box Adjusting Ring

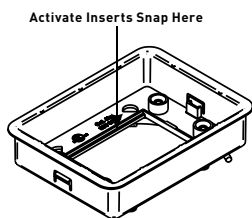

Comes with fiber storage loop. Also includes brass inserts for flange connection and green ground wire for ground connection. Activate modular inserts snap directly into the adjusting ring without the need for an adapter. Also includes mounting screws to attach flange to box body. Ortronics® connectivity inserts do not snap directly into the adjusting ring. For Ortronics inserts use the 828GFITC or 829PFLRT.

NOTE: One 880MPA is needed for each 880MPFC used.

880MP Series Floor Boxes Solid Brass Cover Plate Flanges Ordering Information

817B One-Gang Brass Combination Carpet and Tile Flange

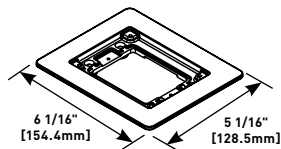

Accepts Ortronics® MAB6TJ TracJack and MAB3S2 Series II adapters and Wiremold CM Series inserts, sold separately.

817C One-Gang Brass Carpet Flange

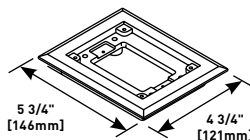

For use on 880S1, 880M1, 880CS1-1 and 880CM1-1 Floor Boxes.

NOTE: UL Listed for tile, terrazzo, polished concrete, wood and carpet floors.

Brass covers and flanges are not interchangeable with aluminum or nonmetallic covers and flanges. Nonmetallic covers are interchangeable with aluminum flanges.

MODULINK™ 880MP SERIES FLOOR BOXES

Modulink 880MP Series Floor Boxes Nonmetallic Cover Plates Flanges Ordering Information

One-Gang Nonmetallic Carpet Flange

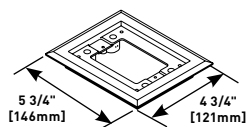

PART NUMBERS:
817PCC-BLK (Black)
817PCC-BRN (Brown)

For Ortronics® connectivity use with 829PFLRT Cover. For Activate™ connectivity use with 829PFL Cover. Accepts Ortronics® MAB6TJ TracJack and MAB3S2 Series II adapters and Wiremold CM Series inserts, sold separately.

Three-Gang Nonmetallic Carpet Flange

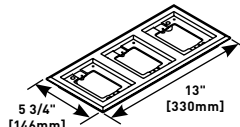

PART NUMBERS:
837PCC-BLK (Black)
837PCC-BRN (Brown)

For Ortronics® connectivity use with 829PFLRT Cover. For Activate™ connectivity use with 829PFL Cover. Accepts Ortronics® MAB6TJ TracJack and MAB3S2 Series II adapters and Wiremold CM Series inserts, sold separately.

Two-Gang Nonmetallic Carpet Flange

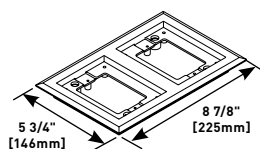

PART NUMBERS:
827PCC-BLK (Black)
827PCC-BRN (Brown)

For Ortronics® connectivity use with 829PFLRT Cover. For Activate™ connectivity use with 829PFL Cover. Accepts Ortronics® MAB6TJ TracJack and MAB3S2 Series II adapters and Wiremold CM Series inserts, sold separately.

NOTE: Brass covers and flanges are not interchangeable with aluminum or nonmetallic covers and flanges. Nonmetallic covers are interchangeable with aluminum flanges.

Modulink 880MP Series Floor Boxes Nonmetallic Cover Plates Ordering Information

Nonmetallic Duplex Cover Plate

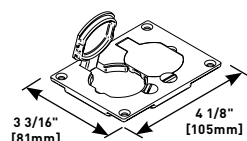

PART NUMBERS:
828PR-BLK (Black)
828PR-BRN (Brown)

Flip lids. Can also be used with a 106 type communication adapter.

Nonmetallic Communications Cover Plate

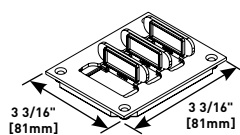

PART NUMBERS:
829PFLRT-BLK* (Black)
829PFLRT-BRN* (Brown)

Individual flip lids. Gasket included. Ortronics® MAB6TJ TracJack and MAB3S2 Series II adapters included.

Nonmetallic GFI Cover Plate

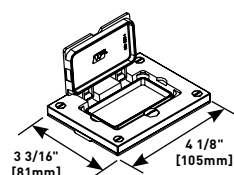

PART NUMBERS:
828PRGFI-BLK (Black)
828PRGFI-BRN (Brown)

May be used with Ortronics® Connectivity systems in conjunction with 817, 827 and 837PCC Series flanges.

Nonmetallic Communications Cover Plate

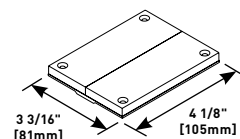

PART NUMBERS:
829PCK-BLK (Black)
829PCK-BRN (Brown)

Breakouts. Feed through only, not for use with a mounting plate for communication jacks.

Nonmetallic Communication Cover Plate

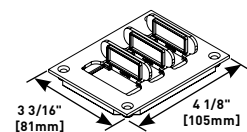

PART NUMBERS:
829PFL-BLK* (Black)
829PFL-BRN* (Brown)

Individual flip lids. Gasket included. Wiremold CM Series inserts included.

Nonmetallic Communications Cover Plate

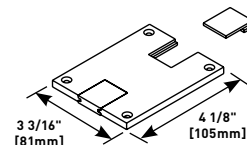

PART NUMBERS:
829PSTC-BLK (Black)
829PSTC-BRN (Brown)

Data slides. Feed through only, not for use with a mounting plate for communication jacks.

* Replacement flip lids can be ordered under Cat. No. PFL-BLK and PFL-BRN. Each Cat. No. comes with three flip lids. The above cover plates are listed for tile and carpet applications.

OMNIBOX™ SERIES FLOOR BOXES

Omnibox Series Nonmetallic Cover Plate Flanges Ordering Information (continued)

Three-Gang Nonmetallic Carpet Flange

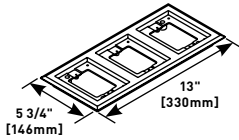

PART NUMBERS:
837PCC-BLK (Black)
837PCC-BRN (Brown)

For Ortronics® connectivity use with 829PFLRT Cover. For Activate™ connectivity use with 829PFL Cover. Accepts Ortronics® MAB6TJ TracJack and MAB3S2 Series II adapters and Wiremold CM Series inserts, sold separately.

Omnibox Series Nonmetallic Cover Plates Ordering Information

Nonmetallic Duplex Cover Plate

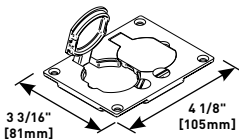

PART NUMBERS:
828PR-BLK (Black)
828PR-BRN (Brown)

Flip lids. Can also be used with a 106 type communication adapter.

Nonmetallic Communication Cover Plate

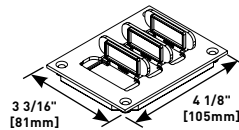

PART NUMBERS:
829PFLRT-BLK (Black)
829PFLRT-BRN (Brown)

Individual flip lids. Gasket included. Ortronics® MAB6TJ TracJack and MAB3S2 Series II adapters included.

Nonmetallic GFI Cover Plate

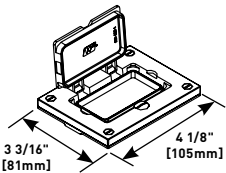

PART NUMBERS:
828PRGFI-BLK (Black)
828PRGFI-BRN (Brown)

May be used with Ortronics® Connectivity systems in conjunction with 817, 827 and 837PCC Series flanges.

Nonmetallic Communications Cover Plate

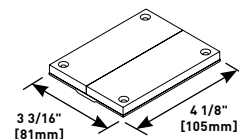

PART NUMBERS:
829PCK-BLK (Black)
829PCK-BRN (Brown)

Breakouts. Feed through only, not for use with a mounting plate for communication jacks.

Nonmetallic Communication Cover Plate

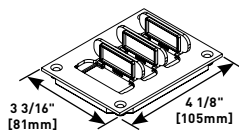

PART NUMBERS:
829PFL-BLK (Black)
829PFL-BRN (Brown)

Individual flip lids. Gasket included. Wiremold CM Series inserts included.

Nonmetallic Communications Cover Plate

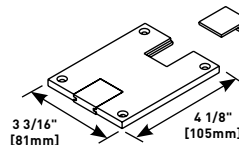

PART NUMBERS:
829PSTC-BLK (Black)
829PSTC-BRN (Brown)

Data slides. Feed through only, not for use with a mounting plate for communication jacks.

NOTE: UL Listed for tile, terrazzo and carpet floors.

Brass covers and flanges are not interchangeable with aluminum or nonmetallic covers and flanges. Nonmetallic covers are interchangeable with aluminum flanges.

880W SERIES™ FLOOR BOXES

880W Series Floor Boxes Nonmetallic Cover Plate Flanges Ordering Information

One-Gang Nonmetallic Carpet Flange

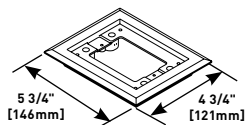

PART NUMBERS:
817PCC-BLK (Black)
817PCC-BRN (Brown)

For Ortronics® connectivity use with 829PFLRT Cover. For Activate™ connectivity use with 829PFL Cover. Accepts Ortronics® MAB6TJ TracJack and MAB3S2 Series II adapters and Wiremold CM Series inserts, sold separately.

Three-Gang Nonmetallic Carpet Flange

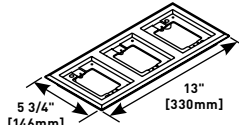

PART NUMBERS:
837PCC-BLK (Black)
837PCC-BRN (Brown)

For Ortronics® connectivity use with 829PFLRT Cover. For Activate™ connectivity use with 829PFL Cover. Accepts Ortronics® MAB6TJ TracJack and MAB3S2 Series II adapters and Wiremold CM Series inserts, sold separately.

Two-Gang Nonmetallic Carpet Flange

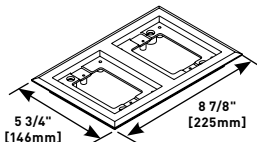

PART NUMBERS:
827PCC-BLK (Black)
827PCC-BRN (Brown)

For Ortronics® connectivity use with 829PFLRT Cover. For Activate™ connectivity use with 829PFL Cover. Accepts Ortronics® MAB6TJ TracJack and MAB3S2 Series II adapters and Wiremold CM Series inserts, sold separately.

880W Series Floor Boxes Nonmetallic Cover Plates Ordering Information

Nonmetallic Duplex Cover Plate

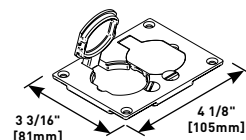

PART NUMBERS:
828PR-BLK (Black)
828PR-BRN (Brown)

Flip lids. Can also be used with a 106 type communication adapter.

Nonmetallic Communications Cover Plate

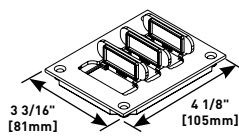

PART NUMBERS:
829PFLRT-BLK (Black)
829PFLRT-BRN (Brown)

Individual flip lids. Gasket included. Ortronics® MAB6TJ TracJack and MAB3S2 Series II adapters included.

Nonmetallic GFI Cover Plate

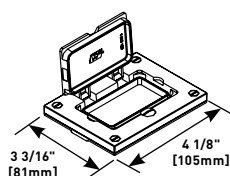

PART NUMBERS:
828PRGFI-BLK (Black)
828PRGFI-BRN (Brown)

May be used with Ortronics® Connectivity systems in conjunction with 817, 827 and 837PCC Series flanges.

Nonmetallic Communications Cover Plate

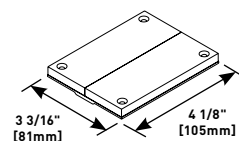

PART NUMBERS:
829PCK-BLK (Black)
829PCK-BRN (Brown)

Breakouts. Feed through only, not for use with a mounting plate for communication jacks.

Nonmetallic Communication Cover Plate

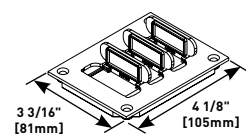

PART NUMBERS:
829PFL-BLK (Black)
829PFL-BRN (Brown)

Individual flip lids. Gasket included. Wiremold CM Series inserts included.

Nonmetallic Communications Cover Plate

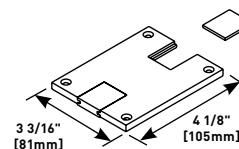

PART NUMBERS:
829PSTC-BLK (Black)
829PSTC-BRN (Brown)

Data slides. Feed through only, not for use with a mounting plate for communication jacks.

NOTE: UL Listed for tile, terrazzo and carpet floors.

Brass covers and flanges are not interchangeable with aluminum or nonmetallic covers and flanges. Nonmetallic covers are interchangeable with aluminum flanges.

WALKERDUCT® PRO SERIES SERVICE FITTINGS

Walkerduct Pro Series Nonmetallic Cover Plate Flanges Ordering Information

One-Gang Nonmetallic Carpet Flange

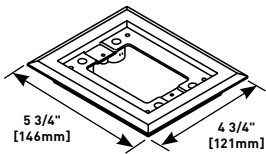

PART NUMBERS:
817PCC-BLK (Black)
817PCC-BRN (Brown)

For Ortronics® connectivity use with 829PFLRT Cover. For Wiremold CM Series inserts use with 829PFL Cover. Accepts Ortronics® MAB6TJ TracJack and MAB3S2 Series II adapters and Wiremold CM Series inserts, sold separately.

Two-Gang Nonmetallic Carpet Flange

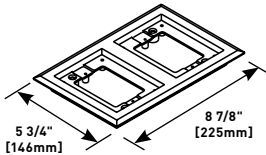

PART NUMBERS:
827PCC-BLK (Black)
827PCC-BRN (Brown)

Available in black or brown. For Ortronics® connectivity use with 829PFLRT Cover. For Wiremold CM Series inserts use with 829PFL Cover. Accepts Ortronics® MAB6TJ TracJack and MAB3S2 Series II adapters and Wiremold CM Series inserts, sold separately.

Three-Gang Nonmetallic Flange

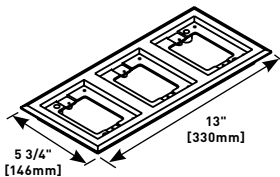

PART NUMBERS:
837PCC-BLK (Black)
837PCC-BRN (Brown)

For Ortronics® connectivity use with 829PFLRT Cover. For Wiremold CM Series inserts use with 829PFL Cover. Accepts Ortronics® MAB6TJ TracJack and MAB3S2 Series II adapters and Wiremold CM Series inserts, sold separately.

NOTE: UL Listed for tile, terrazzo, and carpet floors. Brass covers and flanges are not interchangeable with aluminum or nonmetallic covers and flanges. Nonmetallic covers are interchangeable with aluminum flanges.

Nonmetallic Duplex Cover Plate

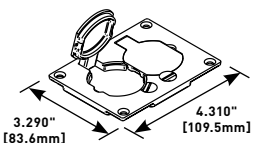

PART NUMBERS:
828PR-BLK (Black)
828PR-BRN (Brown)

Flip lids. Can also be used with a 106 type frame for communications.

NOTE: Brass covers and flanges are not interchangeable with aluminum or nonmetallic covers and flanges. Nonmetallic covers are interchangeable with aluminum flanges.

Nonmetallic GFI cover plate

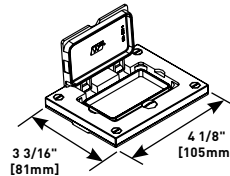

PART NUMBERS:
828PRGFI-BLK (Black)
828PRGFI-BRN (Brown)

May be used with Ortronics® Connectivity systems in conjunction with 817, 827 and 837PCC Series flanges.

Nonmetallic Communications Cover Plate

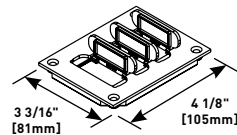

PART NUMBERS:
829PFL-BLK (Black)
829PFL-BRN (Brown)

Individual flip lids.* Gasket included.

Nonmetallic Communications Cover Plate

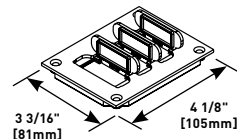

PART NUMBERS:
829PFLRT-BLK (Black)
829PFLRT-BRN (Brown)

Individual flip lids.* Gasket included. Ortronics® MAB6TJ TracJack and MAB3S2 Series II adapters included.

Nonmetallic Communications Cover Plate

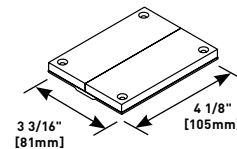

PART NUMBERS:
829PCK-BLK (Black)
829PCK-BRN (Brown)

Individual flip lids.* Gasket included. Ortronics® MAB6TJ TracJack and MAB3S2 Series II adapters included.

Nonmetallic Communications Cover Plate

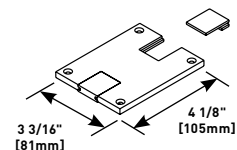

PART NUMBERS:
829PSTC-BLK (Black)
829PSTC-BRN (Brown)

Individual flip lids.* Gasket included. Ortronics® MAB6TJ TracJack and MAB3S2 Series II adapters included.

*Replacement flip lids can be ordered under Cat. No. PFL-BLK and PFL-BRN. Each Cat. No. comes with three flip lids. The above cover plates are listed for tile, terrazzo, and carpet floors.