

# FIRE CLASSIFIED FLOOR BOXES

880MP Series Floor Boxes

## Fire Classified 880MP Floor Box Ordering Information

### 880MPFC Fire Classified Nonmetallic Rectangular Floor Box

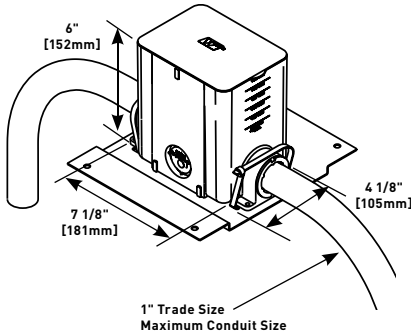

Box comes complete with reusable mudcap, insert spacer, conduit plugs and reducers. Reducers provided for reduction to 1", 3/4" and 1/2" [25mm, 19.1mm and 12.7mm] conduit. Minimum concrete depth is 3 1/2" [89mm] and maximum concrete depth is 6" [152mm]. Minimum capacity is 50 cu. in. [819ml] and maximum capacity is 100 cu. in. [1639ml]. Box dimensions are 4 1/8" W x 5 1/2" L x 6" D [105mm x 140mm x 152mm].

**NOTES:** Insert spacer should not be removed until after concrete pour.  
**880MPFC is a single-gang offering. Can not gang boxes together and maintain Fire Classification.**  
**Floor Box spacing 2' on center and one for every 65 square feet in a span.**  
**Maximum Copper Cross Section per Insert: Four (4) #12 AWG Type THHN Power Conductor or 48 #23 AWG (6 Cat. 6) Tele Data conductors.**

### 880MPA Nonmetallic Floor Box Adjusting Ring

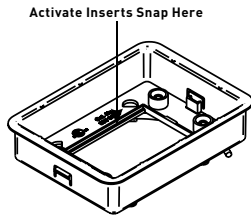

Comes with fiber storage loop. Also includes brass inserts for flange connection and green ground wire for ground connection. Activate modular inserts snap directly into the adjusting ring without the need for an adapter. Also includes mounting screws to attach flange to box body. Ortronics® connectivity inserts do not snap directly into the adjusting ring. For Ortronics inserts use the 828GFITC or 829PFLRT.

**NOTE:** One 880MPA is needed for each 880MPFC used.

## 880MP Series Floor Boxes Solid Brass Cover Plate Flanges Ordering Information

### 817B One-Gang Brass Combination Carpet and Tile Flange

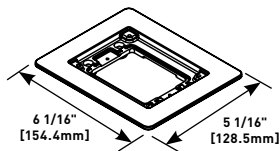

Accepts Ortronics® MAB6TJ TracJack and MAB3S2 Series II adapters and Wiremold CM Series inserts, sold separately.

### 817C One-Gang Brass Carpet Flange

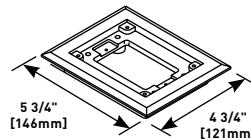

For use on 880S1, 880M1, 880CS1-1 and 880CM1-1 Floor Boxes.

**NOTE:** UL Listed for tile, terrazzo, polished concrete, wood and carpet floors.

Brass covers and flanges are not interchangeable with aluminum or nonmetallic covers and flanges.  
 Nonmetallic covers are interchangeable with aluminum flanges.

# MODULINK™ 880MP SERIES FLOOR BOXES



ModuLink™ Nonmetallic Floor Boxes provide power and communication services directly to the workstation or to any open space location.

## CODE REFERENCE

cULus Listed  
Nonmetallic Outlet Boxes:  
File E110748 Guide QCMZ.

## ModuLink 880MP Series Floor Boxes Ordering Information

### 880MP Nonmetallic Rectangular Floor Box

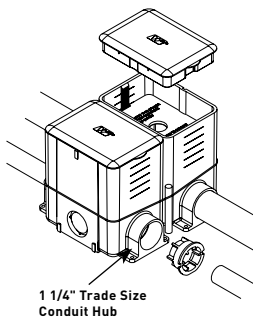

1 1/4" Trade Size  
Conduit Hub

Box comes complete with reusable mudcap, insert spacer, conduit plugs and reducers. Reducers provided for reduction to 1 1/2", 1 1/4", 1", 3/4" and 1/2" [25mm, 19.1mm and 12.7mm] conduit. Minimum concrete depth is 4" [102mm] and maximum concrete depth is 6" [152mm]. Minimum capacity is 50 cu. in. [819ml] and maximum capacity is 100 cu. in. [1693ml]. Box dimensions are 4 1/8" W x 5 1/2" L x 6" H [105mm W x 140mm L x 152mm H].

### 880MPA Nonmetallic Rectangular Floor Box Adjusting Ring

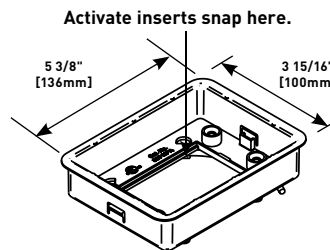

**NOTE:** One 880MPA is needed for each 880MP and 880MP2 box used. For example, a three-gang box will require three 880MPA Adjusting Rings, ordered separately.

Comes with fiber storage loop. Also includes brass inserts for flange connection and green ground wire for ground connection. Wiremold CM Series Open System adapters that snap directly into the adjusting ring without the need for an adapter. Also includes mounting screws to attach flange to box body.

### 880MP2 Nonmetallic Rectangular Floor Box

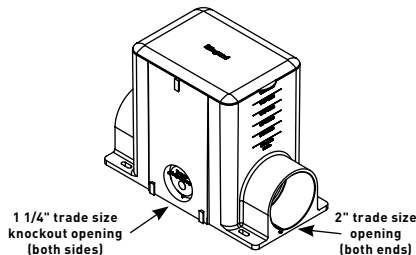

1 1/4" trade size  
knockout opening  
(both sides)

2" trade size  
opening  
(both ends)

Box comes complete with reusable mudcap, insert spacer, conduit plugs and reducers. Reducers provided for reduction to 1 1/2", 1 1/4", 1", 3/4" and 1/2" [38mm, 32mm, 25mm, 19.1mm and 12.7mm] conduit. Minimum concrete depth is 4" [102mm] and maximum concrete depth is 6" [152mm]. Minimum capacity is 50 cu. in. [819ml] and maximum capacity is 100 cu. in. [1639ml]. Box dimensions are 4 1/8" W x 8 1/4" L x 6 3/16" [105mm x 210mm x 157mm].

**NOTE:** Insert spacer should not be removed until after concrete pour.  
Box can be connected together to create a two- or three-gang option.

## COLOR OPTIONS



817, 828, 829, 830, 837 and 838 Series Cover Plates are designed for use with ModuLink™ 880MP Series Floor Boxes and are available in black, aluminum, gray, nickel, brass and bronze.

Custom color options are also available. Consult the factory for more information.