

FIRE CLASSIFIED FLOOR BOXES

880MP Series Floor Boxes

Fire Classified 880MP Floor Box Ordering Information

880MPFC Fire Classified Nonmetallic Rectangular Floor Box

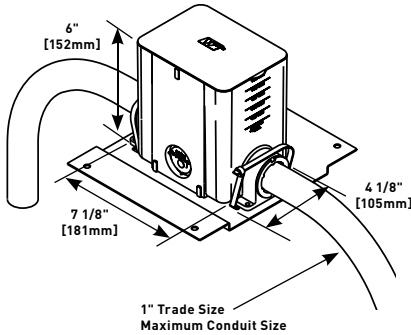

Box comes complete with reusable mudcap, insert spacer, conduit plugs and reducers. Reducers provided for reduction to 1", 3/4" and 1/2" [25mm, 19.1mm and 12.7mm] conduit. Minimum concrete depth is 3 1/2" [89mm] and maximum concrete depth is 6" [152mm]. Minimum capacity is 50 cu. in. [819ml] and maximum capacity is 100 cu. in. [1639ml]. Box dimensions are 4 1/8" W x 5 1/2" L x 6" D [105mm x 140mm x 152mm].

NOTES: Insert spacer should not be removed until after concrete pour.
880MPFC is a single-gang offering. Can not gang boxes together and maintain Fire Classification.
Floor Box spacing 2' on center and one for every 65 square feet in a span.
Maximum Copper Cross Section per Insert: Four (4) #12 AWG Type THHN Power Conductor or 48 #23 AWG (6 Cat. 6) Tele Data conductors.

880MPA Nonmetallic Floor Box Adjusting Ring

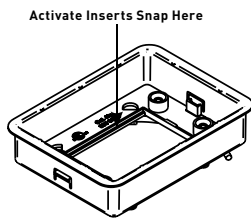

Comes with fiber storage loop. Also includes brass inserts for flange connection and green ground wire for ground connection. Activate modular inserts snap directly into the adjusting ring without the need for an adapter. Also includes mounting screws to attach flange to box body. Ortronics® connectivity inserts do not snap directly into the adjusting ring. For Ortronics inserts use the 828GFITC or 829PFLRT.

NOTE: One 880MPA is needed for each 880MPFC used.

880MP Series Floor Boxes Solid Brass Cover Plate Flanges Ordering Information

817B One-Gang Brass Combination Carpet and Tile Flange

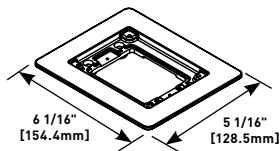

Accepts Ortronics® MAB6TJ TracJack and MAB3S2 Series II adapters and Wiremold CM Series inserts, sold separately.

817C One-Gang Brass Carpet Flange

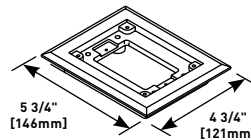

For use on 880S1, 880M1, 880CS1-1 and 880CM1-1 Floor Boxes.

NOTE: UL Listed for tile, terrazzo, polished concrete, wood and carpet floors.

Brass covers and flanges are not interchangeable with aluminum or nonmetallic covers and flanges.
 Nonmetallic covers are interchangeable with aluminum flanges.

RATCHET-PRO™ SERIES FLOOR BOXES

Ratchet-Pro 881 Series Floor Boxes Cover Plates Ordering Information

895DCC Dual Service Brass Duplex Cover Plate

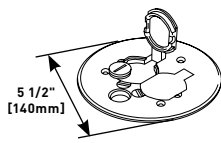

With flip lids. Supplied with 1/2" [12.7mm] screw plug for accessing communication cables. 5 1/2" [140mm] diameter **for carpet applications only**. Used in conjunction with the 881DIV to complete dual-service activation.

Cover Plate

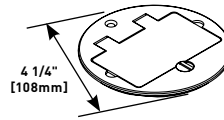

PART NUMBERS:

895TGFI (Brass)
895TGFIAL (Brushed Aluminum)

GFI receptacle cover plate, 4 1/4" [108mm] diameter for tile.

GFI Receptacle Cover Plate

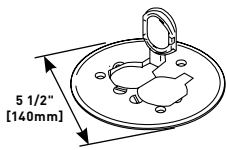

PART NUMBERS:

895 (Brass)
895GTAL (Brushed Aluminum)

With flip lids. Duplex cover plate with flip lids, 5 1/2" [140mm] diameter for carpet.

896 Communication or Power Cover Plate

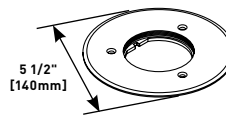

Brass communication or power cover plate with 2 5/8" [67mm] threaded opening, 5 1/2" [140mm] diameter for carpet.

NOTE: Sold without abandon plug.

Duplex Cover Plate with Flip Lids

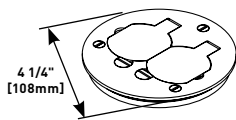

PART NUMBERS:

895T (Brass)
895TAL (Brushed Aluminum)

Duplex cover plate with flip lids, 4 1/4" [108mm] diameter for tile.

896T Communication or Power Cover Plate

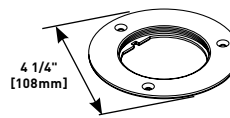

Brass communication or power cover plate with 2 5/8" [67mm] threaded opening, 4 1/4" [108mm] diameter for tile.

NOTE: Sold without abandon plug.

GFI Receptacle Cover Plate

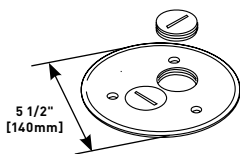

PART NUMBERS:

895SP (Brass)
895SPAL (Brushed Aluminum)

Cover plate with two screw plug openings, 5 1/2" [140mm] diameter for carpet.

896CK Communication or Power Cover Plate

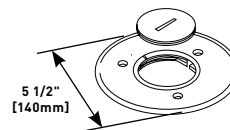

Brass communication or power cover plate with 2 1/4" [57mm] threaded opening, 5 1/2" [140mm] diameter for carpet.

895TSP Cover Plate

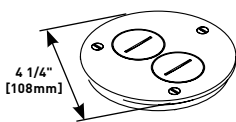

Brass cover plate with two screw plug openings, 4 1/4" [108mm] diameter for tile.

NOTE: Screw plug openings are 1 1/2" [38mm] tapped openings.

896TCK Communication or Power Cover Plate

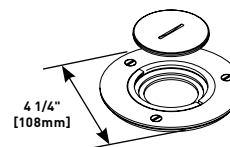

Brass communication or power cover plate with 2 1/4" [57mm] threaded opening, 5 1/2" [140mm] diameter for tile.

GFI Receptacle Cover Plate

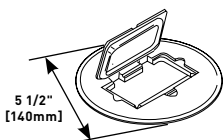

PART NUMBERS:

895GFI (Brass)
895GFICAL (Brushed Aluminum)

GFI receptacle cover plate, 5 1/2" [140mm] diameter for carpet.

Cover Plate

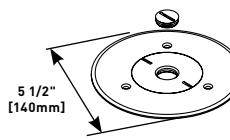

PART NUMBERS:

896CK-1/2 (Brass)
896CKAL-1/2 (Brushed Aluminum)

Cover plate with 1/2" [12.7mm] threaded opening, 5 1/2" [140mm] diameter for carpet.

NOTE: All cover plates are furnished with gasket and three screws.
The 895P Polycarbonate Series Cover Plates must be field modified for dual service.