

FIRE CLASSIFIED FLOOR BOXES

880MP Series Floor Boxes

Fire Classified 880MP Floor Box Ordering Information

880MPFC Fire Classified Nonmetallic Rectangular Floor Box

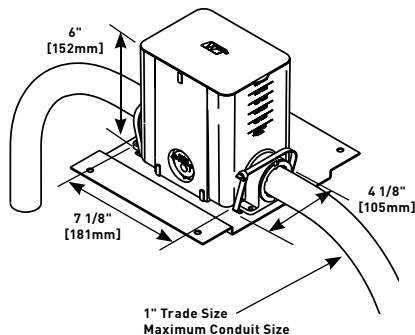

Box comes complete with reusable mudcap, insert spacer, conduit plugs and reducers. Reducers provided for reduction to 1", 3/4" and 1/2" [25mm, 19.1mm and 12.7mm] conduit. Minimum concrete depth is 3 1/2" [89mm] and maximum concrete depth is 6" [152mm]. Minimum capacity is 50 cu. in. [819ml] and maximum capacity is 100 cu. in. [1639ml]. Box dimensions are 4 1/8" W x 5 1/2" L x 6" D [105mm x 140mm x 152mm].

NOTES: Insert spacer should not be removed until after concrete pour.
880MPFC is a single-gang offering. Can not gang boxes together and maintain Fire Classification.
Floor Box spacing 2' on center and one for every 65 square feet in a span.
Maximum Copper Cross Section per Insert: Four (4) #12 AWG Type THHN Power Conductor or 48 #23 AWG (6 Cat. 6) Tele Data conductors.

880MPA Nonmetallic Floor Box Adjusting Ring

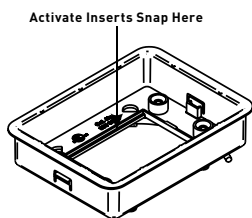

Comes with fiber storage loop. Also includes brass inserts for flange connection and green ground wire for ground connection. Activate modular inserts snap directly into the adjusting ring without the need for an adapter. Also includes mounting screws to attach flange to box body. Ortronics® connectivity inserts do not snap directly into the adjusting ring. For Ortronics inserts use the 828GFITC or 829PFLRT.

NOTE: One 880MPA is needed for each 880MPFC used.

880MP Series Floor Boxes Solid Brass Cover Plate Flanges Ordering Information

817B One-Gang Brass Combination Carpet and Tile Flange

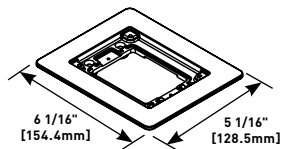

Accepts Ortronics® MAB6TJ TracJack and MAB3S2 Series II adapters and Wiremold CM Series inserts, sold separately.

817C One-Gang Brass Carpet Flange

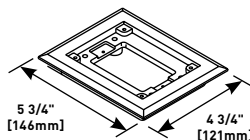

For use on 880S1, 880M1, 880CS1-1 and 880CM1-1 Floor Boxes.

NOTE: UL Listed for tile, terrazzo, polished concrete, wood and carpet floors.

Brass covers and flanges are not interchangeable with aluminum or nonmetallic covers and flanges.
 Nonmetallic covers are interchangeable with aluminum flanges.

FIRE CLASSIFIED FLOOR BOXES

880MP Series Floor Boxes

Cover Plates for 881FC Floor Box

Duplex Cover Plate

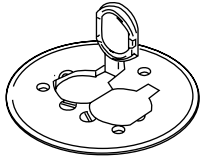

PART NUMBERS:
895 (Brass)
895TCAL (Brushed Aluminum)

With flip lids, 5 1/2" [140mm] diameter for carpet.

GFI Receptacle Cover Plate

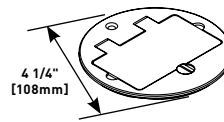

PART NUMBERS:
895TGFI (Brass)
895TGFIAL (Brushed Aluminum)

4 1/4" [108mm] for tile.

Duplex Cover Plate

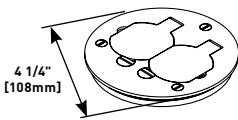

PART NUMBERS:
895T (Brass)
895TAL (Brushed Aluminum)

With flip lids, 4 1/4" [108mm] for tile.

Aluminum Duplex Cover Plate

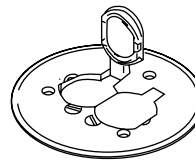

PART NUMBERS:
895TCAL-BK (Black)
895TCAL-GY (Gray)
895TCAL-BS (Brass)
895TCAL-NK (Nickel)
895TCAL-BZ (Bronze)

With flip lids, 5 1/2" [140mm] diameter for carpet.

GFI Receptacle Cover Plate

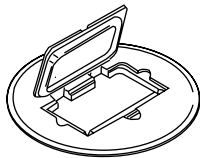

PART NUMBERS:
895GFI (Brass)
895GFIAL (Brushed Aluminum)

5 1/2" [140mm] diameter for carpet.

CAUTION

Installation must comply with NEC and local code conductor volume requirements. Not for use when concrete is the finished floor. Use only for tile, carpet or wood covered floors.

NOTE: 1. All cover plates are furnished with gasket and three screws.
 2. Polycarbonate cover plates cannot be used on the 881FC Fire Classified Floor Box.

Ratchet-Pro Fire Classified Floor Boxes Installation Cross Section

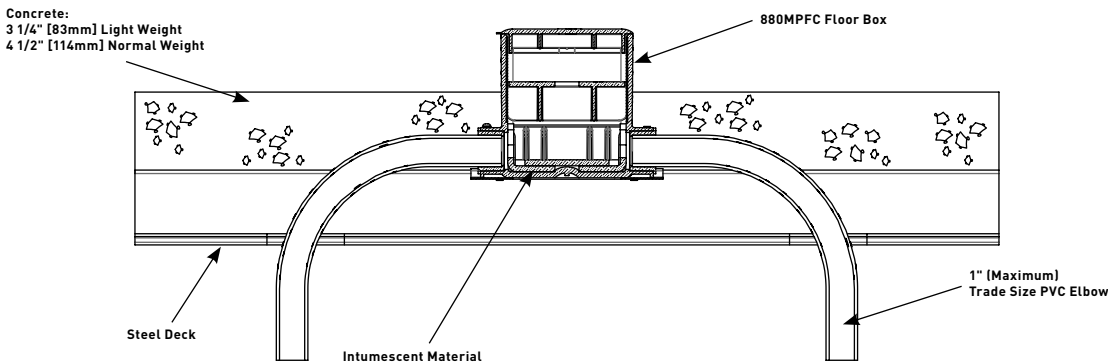

NOTE: UL Listed for tile, terrazzo, polished concrete, wood and carpet floors.

RATCHET-PRO™ SERIES FLOOR BOXES

Ratchet-Pro 881 Series Floor Boxes Cover Plates Ordering Information

895DCC Dual Service Brass Duplex Cover Plate

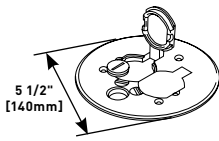

With flip lids. Supplied with 1/2" [12.7mm] screw plug for accessing communication cables. 5 1/2" [140mm] diameter **for carpet applications only**. Used in conjunction with the 881DIV to complete dual-service activation.

Cover Plate

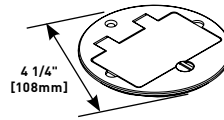

PART NUMBERS:

895TGFI (Brass)
895TGFIAL (Brushed Aluminum)

GFI receptacle cover plate, 4 1/4" [108mm] diameter for tile.

GFI Receptacle Cover Plate

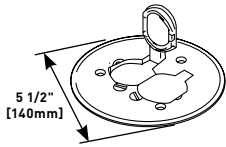

PART NUMBERS:

895 (Brass)
895GTAL (Brushed Aluminum)

With flip lids. Duplex cover plate with flip lids, 5 1/2" [140mm] diameter for carpet.

896 Communication or Power Cover Plate

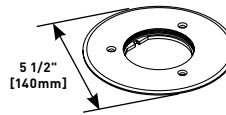

Brass communication or power cover plate with 2 5/8" [67mm] threaded opening, 5 1/2" [140mm] diameter for carpet.

NOTE: Sold without abandon plug.

Duplex Cover Plate with Flip Lids

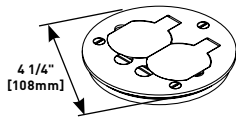

PART NUMBERS:

895T (Brass)
895TAL (Brushed Aluminum)

Duplex cover plate with flip lids, 4 1/4" [108mm] diameter for tile.

896T Communication or Power Cover Plate

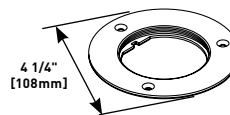

Brass communication or power cover plate with 2 5/8" [67mm] threaded opening, 4 1/4" [108mm] diameter for tile.

NOTE: Sold without abandon plug.

GFI Receptacle Cover Plate

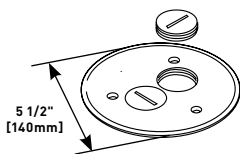

PART NUMBERS:

895SP (Brass)
895SPAL (Brushed Aluminum)

Cover plate with two screw plug openings, 5 1/2" [140mm] diameter for carpet.

896CK Communication or Power Cover Plate

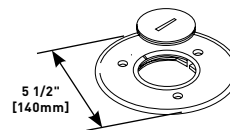

Brass communication or power cover plate with 2 1/4" [57mm] threaded opening, 5 1/2" [140mm] diameter for carpet.

895TSP Cover Plate

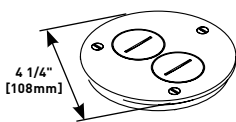

Brass cover plate with two screw plug openings, 4 1/4" [108mm] diameter for tile.

NOTE: Screw plug openings are 1 1/2" [38mm] tapped openings.

896TCK Communication or Power Cover Plate

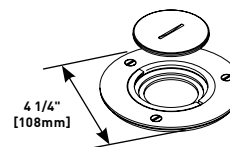

Brass communication or power cover plate with 2 1/4" [57mm] threaded opening, 5 1/2" [140mm] diameter for tile.

GFI Receptacle Cover Plate

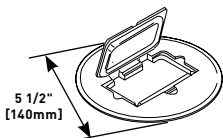

PART NUMBERS:

895GFI (Brass)
895GFICAL (Brushed Aluminum)

GFI receptacle cover plate, 5 1/2" [140mm] diameter for carpet.

Cover Plate

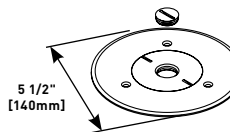

PART NUMBERS:

896CK-1/2 (Brass)
896CKAL-1/2 (Brushed Aluminum)

Cover plate with 1/2" [12.7mm] threaded opening, 5 1/2" [140mm] diameter for carpet.

NOTE: All cover plates are furnished with gasket and three screws.
The 895P Polycarbonate Series Cover Plates must be field modified for dual service.

880 SERIES™ FLOOR BOXES

880 Series Floor Box Cover Plates Ordering Information

Duplex Cover Plate with Flip Lid

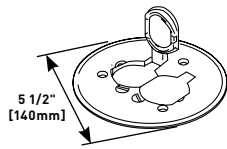

PART NUMBERS:
895 (Brass)
895TCAL (Brushed Aluminum)

Duplex cover plate with flip lids,
 5 1/2" [140mm] for carpet.

Aluminum Duplex Power Plate

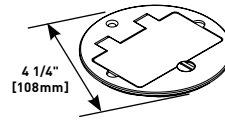

PART NUMBERS:
895TGFI (Brass)
895TGFIAL (Brushed Aluminum)

GFI receptacle cover plate, 4 1/4"
 [108mm] for tile.

Aluminum Duplex Cover Plate

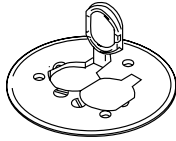

PART NUMBERS:
895TCAL-BK (Black)
895TCAL-GY (Gray)
895TCAL-NK (Nickel)
895TCAL-BS (Brass)
895TCAL-BZ (Bronze)

With flip lids, 5 1/2" [140mm]
 diameter for carpet.

Nonmetallic Duplex Power Plate

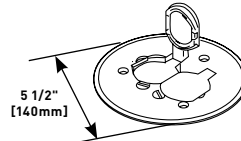

PART NUMBERS:
895P-BLK (Black)
895P-BRN (Brown)
895P-BRZ (Bronze)
895P-AL (Brass)

Polycarbonate duplex cover plate
 with flip lids for carpet.

Duplex Cover Plate with Flip Lids

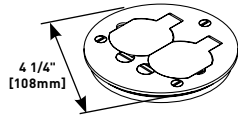

PART NUMBERS:
895T (Brass)
895TAL (Brushed Aluminum)

Duplex cover plate with flip lids,
 4 1/4" [108mm] for tile.

896 Communication or Power Cover Plate

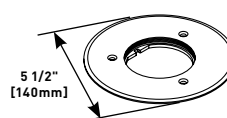

Brass communication or power
 cover plate with 2 5/8" [67mm]
 threaded opening for carpet. Sold
 without abandon plug.

Cover Plate With Two Screw Plug Openings

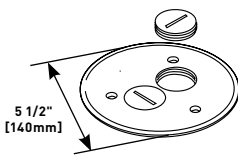

PART NUMBERS:
895SP (Brass)
895SPAL (Brushed Aluminum)

Cover plate with two 1 1/2" [38mm]
 screw plug openings, 5 1/2"
 [140mm] for carpet.

896T Communications or Power Cover Plate

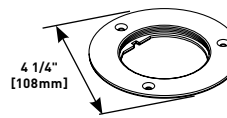

Brass communications or power
 cover plate with 2 5/8" [67mm]
 threaded opening for tile. Sold
 without abandon plug.

895TSP Cover Plate With Two Screw Plug Openings

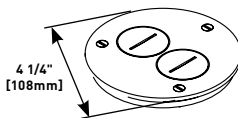

Brass cover plate with two 1 1/2"
 [38mm] screw plug openings, 4 1/4"
 [108mm] for tile.

896CK Communications or Power Cover Plate

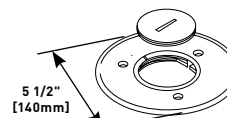

Brass communications or power
 cover plate with 2 1/4" [57mm]
 threaded opening for carpet.

GFI Receptacle Cover Plate

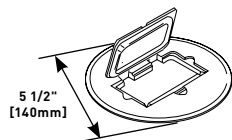

PART NUMBERS:
895GFI (Brass)
895GFIICAL (Brushed Aluminum)

GFI receptacle cover plate, 5 1/2"
 [140mm] for carpet.

896TCK Communications or Power Cover Plate

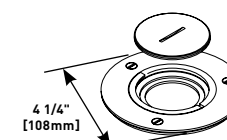

Brass communications or power
 cover plate with 2 1/4" [57mm]
 threaded opening for tile.