

PLUGMOLD® 2000TR SERIES™



Plugmold® 2000TR Series™ Tamper-Resistant Multi-Outlet Systems meet the 2008 NEC requirement 406.11 for Tamper Resistant receptacles in dwelling units.

CODE REFERENCE

cULus Listed Base & Blank Cover:
File E4376 Guide RJBT.

Multi-Outlet Assemblies:
File E15191 Guide PVGT.

Fittings:
File E41751 Guide RJPR.

Base & Blank Cover
Meets Article 386 of NEC.

Plugmold Strips:
Meets Article 380 of NEC.

Steel Plugmold 2000TR Series Ordering Information

Tamper-Resistant Plugmold

Plugmold 2000TR Series
Cross Section

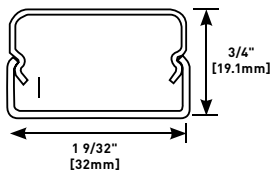

- PART NUMBERS:**
V20GB306TR
V20GB506TR (Ivory)
WH20GB306TR
WH20GB506TR (White)
G20GB306TR
G20GB506TR (Gray)
BK20GB306TR
BK20GB506TR (Black)
S20GB306TR
S20GB506TR
S20GB606TR (Stainless Steel)

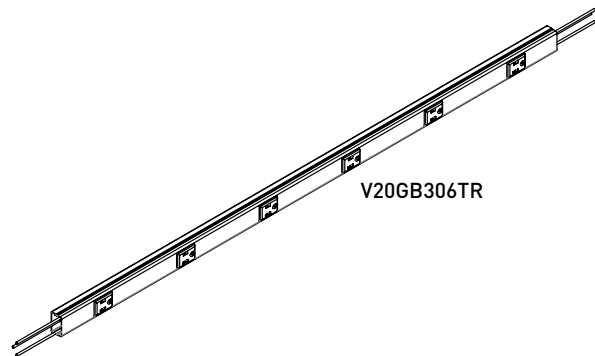

Available in 3' [914mm] and 5' [1.5m] lengths with 6" [152mm] receptacle spacing. 15A tamper-resistant receptacles. 3-wire, #12 THHN (1 hot, 1 neutral, and insulated ground conductor). .040" [1.0mm] steel housing. Packed 2 per carton. Each unit supplied with one (1) Coupling and two (2) Blank End Fittings.

COLOR OPTIONS



2000 Series Plugmold is available in an Ivory, Gray, Black, or White baked enamel finish or in durable stainless steel or satin anodized aluminum unless otherwise specified in the part number description.

Custom color options are also available. Consult the factory for more information.

PLUGMOLD® 2000TR SERIES™

Steel Plugmold 2000TR Series Ordering Information (continued)

2001 Coupling

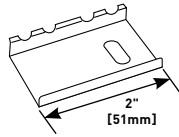

Joins lengths of Plugmold 2000TR Series together.

V2051H Back Feed Fitting

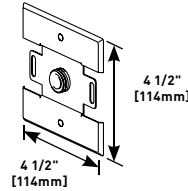

Feeds Plugmold 2000TR Series from an existing outlet box. Equipped with 1/2" trade size male bushing and lock nut washer for grounding.

2009 Ground Clamp

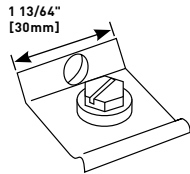

Connects equipment grounding conductor to Plugmold 2000TR Series.

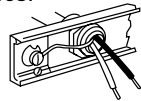

How 2009 is used.

Entrance End Fitting

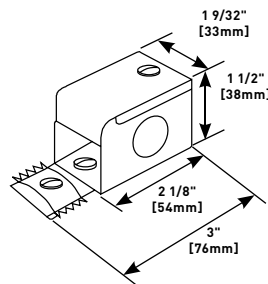

PART NUMBERS:
V2010A2 (Ivory)
WH2010A2 (White)
G2010A2 (Gray)
BK2010A2 (Black)
S2010A2 (Stainless Steel)

Connects Plugmold 2000TR Series with 1/2" trade size conduit and armored cable connectors. 1/2" trade size KOs on end, each side and bottom. Includes ground screw.

Blank End Fitting

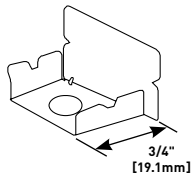

PART NUMBERS:
V2010B (Ivory)
WH2010B (White)
G2010B (Gray)
BK2010B (Black)
S2010B (Stainless Steel)

Closes off open end of sections of Plugmold 2000TR Series.

Entrance End Fitting

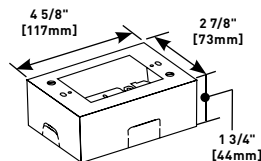

PART NUMBERS:
V2040B (Ivory)
WH2040B (White)
G2040B (Gray)
BK2040B (Black)
S2040B (Stainless Steel)

One-gang device box. Cover has one twistout for 2000 Series Plugmold on two sides and one twistout for 500® and 700® Series Raceway on the top and bottom. Base includes knockout to enable extension from existing single-gang flush wall box and 1/2" trade size KOs. Accepts industry standard faceplates for electrical and communication devices.