

PLUGMOLD® 2000 SERIES™



Two-piece, low profile multiple outlet raceway. Low profile requires minimal space.

CODE REFERENCE

cULus Listed Base & Blank Cover:
File E4376 Guide RJBT.

Multi-Outlet Assemblies:
File E15191 Guide PVGT.

Fittings:
File E41751 Guide RJPR.

Base & Blank Cover & Plugmold Series with Snapicoil Harness:
Meets Article 386 of NEC.
Meets Section 12-3032 of CEC.

Plugmold Wired Sections:
Meets Article 380 of NEC.
Meets Section 12-3032 of CEC.

Plugmold 2000 Series System Layout

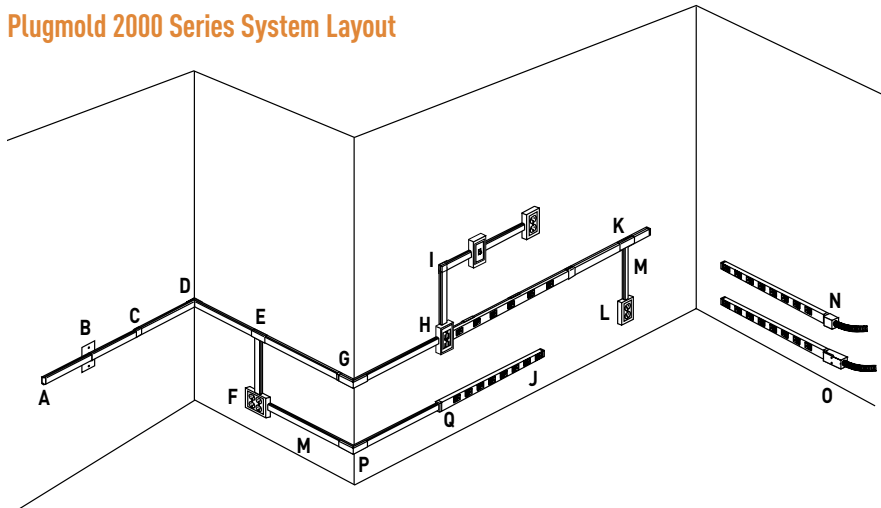

NOTE: Illustration is for showing product applications only.

KEY

- A. V2010B Blank End Fitting
- B. V2051H Flush Plate Adapter
- C. V2006 Cover Clip
- D. 2017TC Internal Corner Coupling
- E. V2015 Tee Fitting
- F. V2048-2 Two-Gang Device Box
- G. V2018C Extern Elbow Cover
- H. V2048 Single-Gang Device Box
- I. V2011 90° Flat Elbow
- J. V20GB506 Plugmold Strip
- K. V2089 Side-Reducing Fitting
- L. V5748 Single-Gang Device Box
- M. V500 500 Series Raceway
- N. V2010A2 Entrance End Fitting
- O. V2010A3 Entrance End Fitting
- P. V518 External Elbow
- Q. V2089E End-Reducing Connector

COLOR OPTIONS



Plugmold® 2000 Series™ Part Numbers with a "V" prefix have an ivory finish. Part Numbers with a "G" prefix have a gray finish. Part Numbers with a "S" prefix have a stainless finish. Part Numbers with a "WH" prefix have a white finish. Part Numbers with a "BK" prefix have a black finish. Part Numbers without a prefix have a galvanized steel finish unless otherwise specified.

Custom color options are also available. Consult the factory for more information.

PLUGMOLD® 2000 SERIES™

Plugmold 2000 Series Ordering Information (continued)

2009 Ground Clamp (Galvanized)

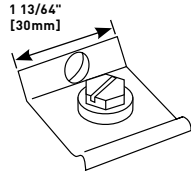

Connects equipment grounding conductor to provide an additional ground to raceway.

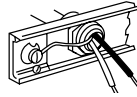

How 2009 is used.

Entrance End Fitting

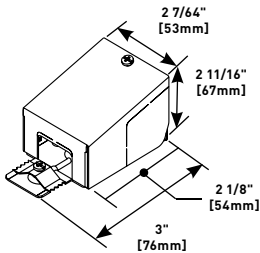

PART NUMBERS:
V2010A3 (Ivory)
WH2010A3 (White)
G2010A3 (Gray)
BK2010A3 (Black)

Offers larger capacity than V2010A2. 1/2" trade size KOs on end, each side and bottom. 3/4" trade size KOs on bottom and rear. Includes ground screw.

2010A2 Entrance End Fitting

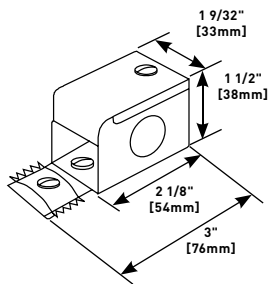

Connects 2000 Series Raceway with 1/2" trade size conduit and armored cable connectors. 1/2" trade size KOs on end, each side and bottom. Includes ground screw.

Blank End

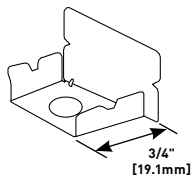

PART NUMBERS:
V2010B (Ivory)
WH22010B (White)
G2010B (Gray)
BK2010B (Black)
S2010B (Stainless Steel)

Closes off open end of 2000 Series Raceway.

90° Flat Elbow

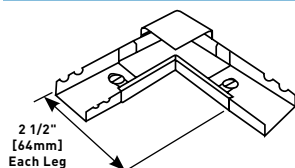

PART NUMBERS:
V2011 (Ivory)
WH2011 (White)
G2011 (Gray)
BK2011 (Black)
S2011 (Stainless Steel)

Right angle turns on same surface. Cover stop permits neat butting of 2000C Cover. Two couplings furnished.

Tee

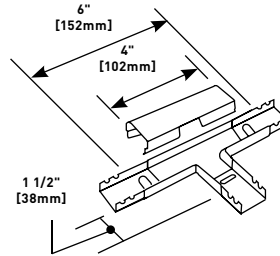

PART NUMBERS:
V2015 (Ivory)
WH2015 (White)
G2015 (Gray)
BK2015 (Black)

Branches raceway at right angles. Couplings furnished.

2017TC Internal Corner Coupling

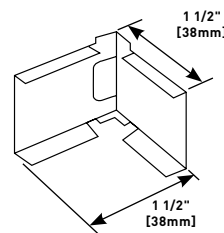

Furnished with one fiber bushing.

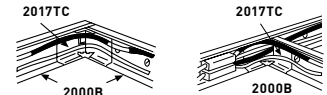

1. 2017TC used as a corner coupling.
2. 2017TC used as a corner coupling and a straight-through fitting.

External Elbow Cover

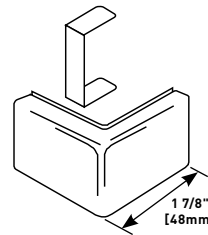

PART NUMBERS:
V2018C (Ivory)
WH2018C (White)
G2018C (Gray)
BK2018C (Black)
S2018C (Stainless Steel)

Continues raceway runs around outside corner. Fills the gap when external corner is made by notching and bending the 2000 Base.

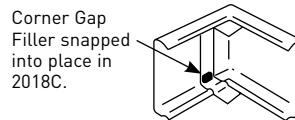

Corner Gap Filler snapped into place in 2018C.

Single-Gang Device Box

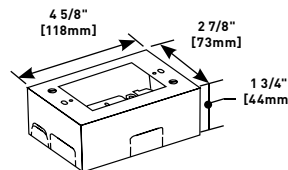

PART NUMBERS:
V2048 (Ivory)
WH2048 (White)
G2048 (Gray)
BK2048 (Black)
S2048 (Stainless Steel)

Cover has twistouts for 2000, 500 and 700 Series Raceways. Base has 1/2" trade size KO and rectangular KO for extension to wall box. Base has No. 10 threaded hole for ground connection.