

5400 SERIES™ RACEWAY

Large Capacity, Multiple Channel



Large capacity, multiple channel raceway. Lightweight and easy-to-cut. Ideal for power or communication installations that require multiple services.

CODE REFERENCE

Listed Raceway:

File E90378 Guide RJTX.

Complies with flammability requirements of UL-5A.

Fittings: File E90377 Guide RJYT.

Meets Article 388 of NEC.

UL Listed for up to 600V.

Meets Section 12-1600 of CEC.

5400 Series Raceway System Layout

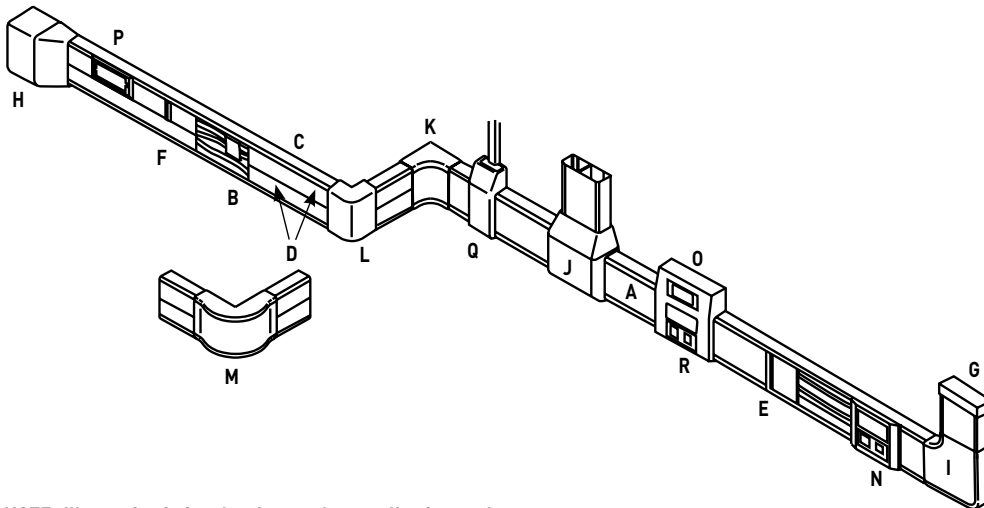

NOTE: Illustration is for showing product applications only.

KEY

- A. 5400C Raceway Cover
- B. 5400TWC Twin Cover Wire Clip
- C. 5400TB Two Compartment Base
- D. 5400TC Twin Snap Cover
- E. 5406A Cover Clip
- F. 5406T Twin Cover Seam Clip

- G. 5410 Entrance End Fitting
- H. 5410DFO Entrance End Feed
- I. 5411FO Flat Elbow
- J. 5415 Tee
- K. 5417FO Radiused Internal Elbow
- L. 5418 Standard External Elbow

- M. 5418FO Radiused External Elbow
- N. 5450 In-Line Device Bracket
- O. 5450A3 Multiple Device Bracket
- P. 5450T Twin Snap Device Bracket
- Q. 5474 Transition Fitting
- R. Communication Device

COLOR OPTIONS



5400 Series™ Raceway Part Numbers with a "-WH" suffix have a white finish. Part Numbers without a suffix are only available in an ivory finish. 5400 Series Raceway is paintable using latex paint or stain.

Custom color options are also available. Consult the factory for more information.

5400 SERIES™ RACEWAY

Ordering Information

Base Seam Clip

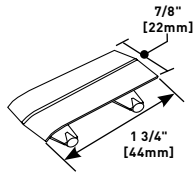

PART NUMBERS:
5406TB (Ivory)
5406TB-WH (White)

For covering joint where two pieces of 5400TB Base come together. One clip per package.

Radiused Full Capacity Flat Elbow

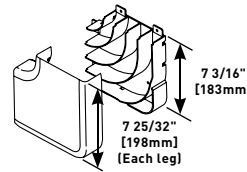

PART NUMBERS:
5411FO (Ivory)
5411FO-WH (White)

For right angle turns on the same surface. Integral dividers provide 2" [51mm] cable bend radius for UTP and fiber optic installations. Ideal for lay-in or pull-through installations.

Transition Fitting

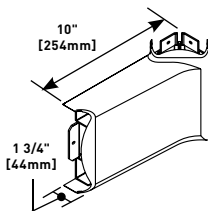

PART NUMBERS:
5408L (Ivory)
5408L-WH (White)

For transitioning from MXN2A08 Corner Drop to a horizontal run of 5400TB Series Raceway to the left.

Tee

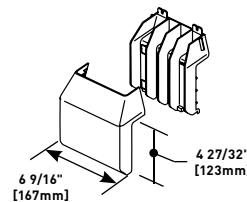

PART NUMBERS:
5415 (Ivory)
5415-WH (White)

For branching raceway at right angles.

Transition Fitting

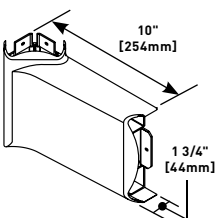

PART NUMBERS:
5408R (Ivory)
5408R-WH (White)

For transitioning from MXN2A08 Corner Drop to a horizontal run of 5400TB Series Raceway to the right.

Tee

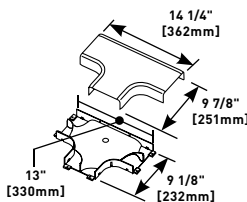

PART NUMBERS:
5415FO (Ivory)
5415FO-WH (White)

A full capacity tee fitting for branching raceway at right angles. Provides separation of services and 2" [51mm] cable bend radius for UTP and fiber optic installations.

Blank End Fitting

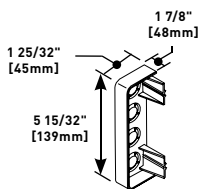

PART NUMBERS:
5410 (Ivory)
5410-WH (White)

For closing open end of 5400 Series Raceway. Has four 1/2" trade size KOs for end feed.

Radiused Full Capacity Internal Elbow

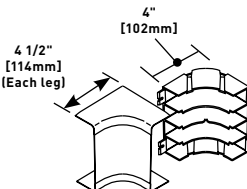

PART NUMBERS:
5417FO (Ivory)
5417FO-WH (White)

For right angle turns around internal corners. Integral dividers provide 2" [51mm] cable bend radius for UTP and fiber optic installations. Ideal for lay-in or pull-through installations.

Radiused Divided Entrance End Cap

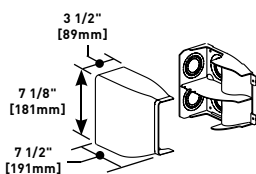

PART NUMBERS:
5410DFO (Ivory)
5410DFO-WH (White)

FiberReady divided fitting to feed 5400 Series Raceway. Includes 1", 1 1/4", 1 1/2", and 2" trade size KOs on back and top.

External Elbow

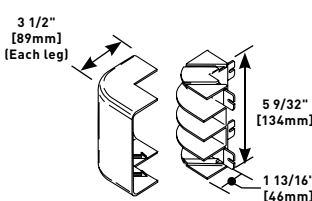

PART NUMBERS:
5418 (Ivory)
5418-WH (White)

For right angle turns around external corners.