

Schedule 40

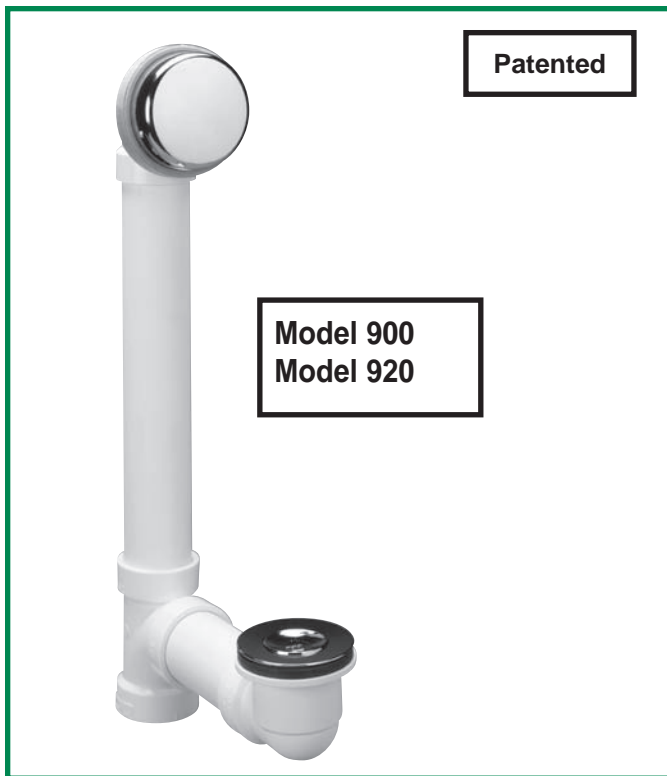

Not Shown: Half Kits (No Tee or Pipe)

Model 901: Stoppers, Knobs, Strainer Bodies determined by type of tub closure, i.e., Lift and Turn, etc.

Model 921-PP: ABS Stopper, Plastic Knob, Brass Strainer Body, Chrome PP only

Model 951-PP: ABS Stopper, Plastic Knob, Zinc Strainer Body, Chrome PP only



Includes built-in test membrane



Easily remove membrane after test



Snap-on overflow plate. No screws

See price list for complete item numbers and available options.

When ordering, please specify complete item number and any applicable option codes.



For More Information Contact:
WATCO Manufacturing Company
 1220 South Powell Road
 Independence, MO 64057-2724
 Ph. 816-796-3900 • FAX 816-796-0875
www.watcomfg.com

Innovator® 900/901
 Stoppers, Knobs, and Bodies determined by tub closure selected

Innovator® 920/921
 ABS Plastic Stopper, Plastic Knob, Brass Body, Chrome PP only

Innovator® 951 Half Kit
 ABS Plastic Stopper, Plastic Knob, Zinc Body, Chrome PP only

Sturdy 1.5" Schedule 40 PVC or ABS Solvent Weld Assembly

SPECIFICATIONS

FEATURES:

- Eliminates all screws
- Eliminates need for separate overflow test plug
- Eliminates leaks due to loose overflow attachment
- Eliminates dual inventory of one- and two-hole overflow plates

APPROVALS (900/901 models):

- Manufactured in compliance with ASME A112.18.2-2005/ CSA B125.2-2005.

PATENTS (Innovator®):

- U.S. Pat. Numbers 5,890,241; 6,637,050; 6,675,406; 7,127,752; and Patents Pending
- Canadian Patent Number 2,437,448
- Mexican Patent Numbers PA/a/2003007344; PA/a/2005002784

THREADS (Strainer Body and Drain Elbow):

- 1 1/2" – 1 1/2 NPSM (Coarse Thread)
- 1.865" Major Diameter (outside thread diameter)
- 11.5 threads per inch

PIPING: PVC ABS

ROUGH-IN (RI's) and STOPPER/FACEPLATE (SF's)

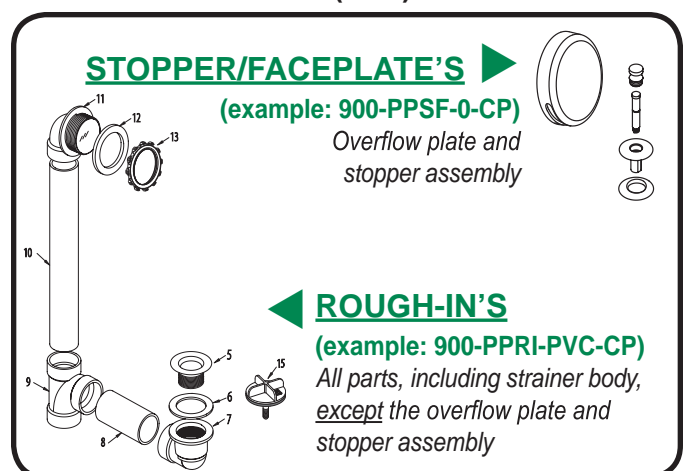

900/901 Series Parts List

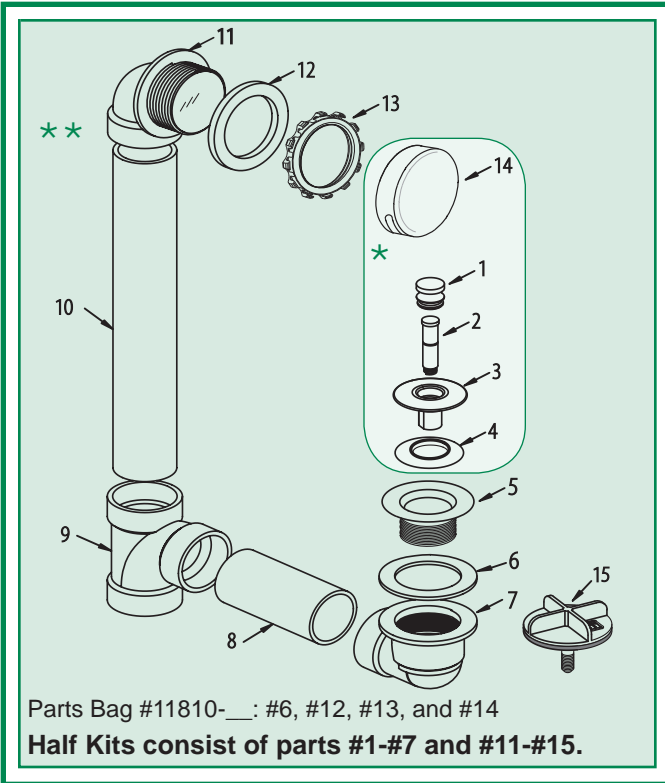

Item	Part #	Description
1.	01010CP	PUSH PULL® Knob, Brass
2.	11510	Friction Ring (11505) and Post (11532)
3.	01013CP	Stopper, Brass
4.	11507	Seal, 1 1/16" dia.
5.	01016CP	Strainer Body, 1.865" - 11.5 - 1.25"
6.	10696	Drain Ell Washer, 1.5" gray
7.	11008	Drain Ell, Schedule 40, ABS
	14008	Drain Ell, Schedule 40, PVC
8.	SCHABS-4.625	Pipe, Schedule 40, ABS, 1.5" x 4.625"
	SCHPVC-4.625	Pipe, Schedule 40, PVC, 1.5" x 4.625"
9.	14011	Sanitary Tee, Schedule 40, ABS
	14010	Sanitary Tee, Schedule 40, PVC
10.	SCHABS-11.75	Pipe, Schedule 40 ABS, 1.5" x 11.75"
	SCHPVC-11.75	Pipe, Schedule 40 PVC, 1.5" x 11.75"
11.	11020	Innovator® Overflow Ell, Schedule 40, ABS
	14020	Innovator® Overflow Ell, Schedule 40, PVC
12.	10675	Overflow Ell Washer, Foam
13.	11121	Retainer Nut for Innovator®
14.	01004CP	Overflow Plate for Innovator®
15.	11575	Test Plug with O-Ring-type Gasket

*** SF: (example: 900-PPSF) Parts #1 thru #4, and #14**

**** RI: (example: 900-PPRI) Parts #5 thru #13, and #15**

OPTIONAL TUB CLOSURES FOR 900/901-SERIES BATH WASTES (PUSH PULL® ALSO SHOWN ABOVE)

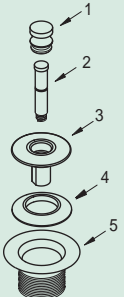
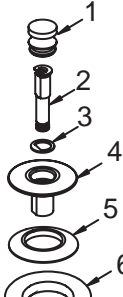
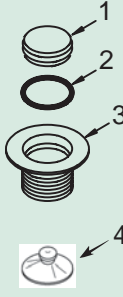
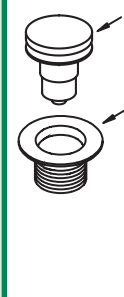
900/01 PUSH PULL® Coarse Thread	LIFT & TURN Coarse Thread	PRESFLO® Coarse Thread	FOOT ACTUATED Coarse Thread
 <ol style="list-style-type: none"> 01010CP 01010_* 11510 01013CP 01013_* 11507 01016CP 01016_* 	 <ol style="list-style-type: none"> 01010CP 01010_* 11079 11088 11290CP 01013_* 11507 11492CP 01016_* 	 <ol style="list-style-type: none"> 11145CP 11145_* 11132 11060CP 11060_* 96039: Suction Cup for removing stopper 	 <ol style="list-style-type: none"> 38412CP 38412_* 11492CP 01016_*

U.S. Pat. No. 4,720,877 U.S. Pat. No. 5,758,368 U.S. Pat. No. 4,457,030

***If finish other than Chrome is desired, please use this part number and indicate desired finish.**

Finishes Available in the 900/901 Series:

- 921 PUSH PULL®**
- 11309CP
 - 11510
 - 11290CP
 - 11507
 - 01016CP
- 951 PUSH PULL®**
- 11309CP
 - 11510
 - 11290CP
 - 11507
 - 11492CP

Tub Closures:	PUSH PULL®	LIFT & TURN	PRESFLO®	FOOT ACT.
CP - Chrome Plated	●	●	●	●
AB - Antique Brass				
AP - Aged Pewter	●	●	●	
BB - Brushed Bronze	●	●	●	
BN - Brushed Nickel	●	●	●	●
BO - Bone	●	●		
BS - Biscuit	●	●		
BZ - Oil-Rubbed Bronze	●	●	●	●
CB - Chrome Brushed	●	●	●	
NP - Nickel Polished	●	●	●	●
PB - Polished Brass	●	●	●	●
PN - Pearl Nickel	●	●	●	
WH - White	●	●		
WI - Wrought Iron	●	●	●	

Roughing-In Dimensions

