

No. 10

Capacity: 1/8" through 1" O.D.

No. 15

Capacity: 3/16" through 1 1/8" O.D.

No. 20

Capacity: 5/8" through 2 1/8" O.D.

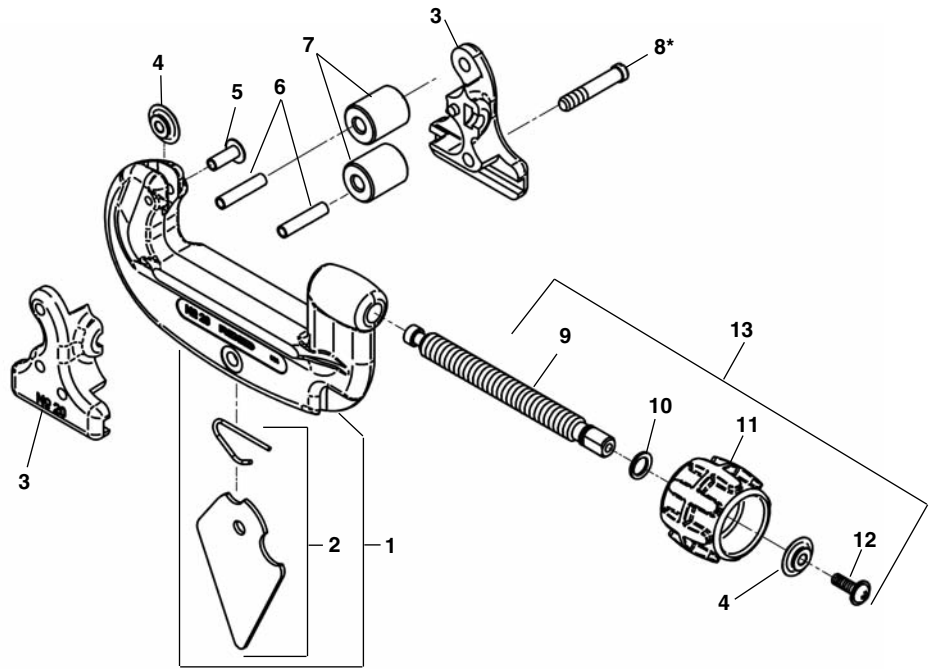

**NOTE: Order parts by Catalog Number only.
DO NOT order by Reference Number.**

	10 1/8"-1"	15 3/16"-1 1/8"	20 5/8"-2 1/8"
Ref. No.	Catalog No.	Catalog No.	Catalog No.
Description			
1 Frame Assembly	34605	34600	33575
2 Reamer Blade, Spring & Pin	34330	34335	34340
3 Roll Housing	33760	34610	33580
4 Cutter Wheel (Thin)	33160	33160	33160
4 Cutter Wheel (Heavy-Duty)	33165	33165	33165
5 Quick Change Pin	21533	21533	21533
5 Wheel Screw (OLD STYLE)	34325	34325	34345
6 Roll Pin	34860	*	*
7 Roll	34830	34805	34825
8* Roll Housing Screw	34300	34615	34620
9 Feed Screw	11308	11323	11313
10 Retaining Ring	11298	11303	11303
11 Knob w/Screw	33177	33182	33182
12 Screw	61097	61097	61097
13 Feed Screw Assembly (Includes Ref. Nos. 9-12)	34590	34585	34595

*Three Roll Housing Screws (Ref. No. 8) used in place of Roll Pins.

No. 30

Capacity: 1" through 3" O.D.

Ref. No.	Catalog No.	Description
1	33375	Frame Assembly
2	34360	Wheel Screw
3	34420	Stop Screw
4	33932	Roll Pin
5	34365	Screw Handle
6	33520	Roll Housing
7	34370	Roll
8	33170	Cutter Wheel (Thin)
	33175	Cutter Wheel (Heavy-Duty)

