

Type	-09	-15	-20
P3287	<input type="checkbox"/>	<input type="checkbox"/>	<input type="checkbox"/>
P3288	<input type="checkbox"/>	<input type="checkbox"/>	<input type="checkbox"/>
P3289	<input type="checkbox"/>	<input type="checkbox"/>	<input type="checkbox"/>

Catalog No.	Finish			Lamping	Dimensions (Inches)			
	Brushed Nickel	Polished Chrome	Antique Bronze		A	B	C	D
P3287	-09	-15	-20	1 (m) 100w	5-1/4	8-1/4	8	3-3/4
P3288	-09	-15	-20	2 (m) 100w	11-3/4	8-1/4	8-1/4	2-3/4
P3289	-09	-15	-20	3 (m) 100w	16	8-1/4	8-1/4	2-1/2

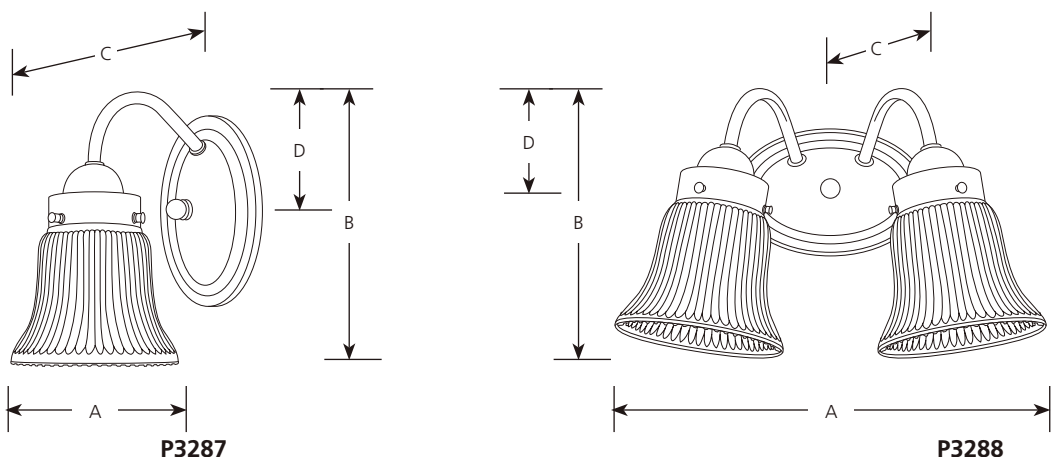

Specifications:

General

- Clear fluted glass shades: 4-7/8" dia. x 4-9/16" ht.
- Brushed nickel and Polished chrome units have plain canopies and cups
- Plated finishes
- Steel construction
- Glass held in place with thumb screws

Electrical

- Pre-wired
- Medium based ceramic sockets

Labeling

- UL-CUL damp location listed

Mounting

- Wall mounted
- Can be mounted in up or down position
- Canopy or back plate covers a standard 4" octagonal recessed outlet box
- Plain oval back plate is 4-1/4" W x 6-1/8" T x 1-3/16" deep
- Melon oval back plate is 4-1/16" W x 6-1/8" T x 1-9/32" deep
- Mounting strap for outlet box included