

WALL PLATES

Specifications



**Thermoset
SP Series**



**Nylon
TP Series**



**Screwless
Polycarbonate
SWP Series**



**302/304
Stainless
Steel**



**Polished
Brass**

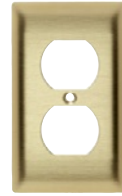

**Brushed
Brass**



Aluminum

Application

Legrand's broad line of Pass & Seymour® Standard Size Plastic and Metal Wall Plates features the most complete range of types, sizes, colors, and finishes available. Choose from more than 1,900 standard plates in non-combustible thermoset plastic material, self-extinguishing nylon material, screwless polycarbonate material, or attractively finished metal, for residential, commercial, institutional, and industrial applications. All plastic wall plates color match to Pass & Seymour devices.

Thermoset Plastic Wall Plates

- Molded of non-combustible mar-proof material.
- Available in "SP" series in Standard, Junior-Jumbo, and Jumbo sizes.
- Seven standard colors available – Ivory, White, Brown, Gray, Black, Red, and Light Almond.
- Individually wrapped with color-matching screws.
- Resistant to discoloration, grease, oil, solvent and moisture.
- Nominal thickness, .070"

TradeMaster® Thermoplastic Wall Plates

- Molded of rugged, practically indestructible self-extinguishing nylon. ("TP" series only)
- Available in "TP" series, extra 3/16" width and height than Standard size plates; and "TPJ" series, extra 3/16" width and height than Junior-Jumbo size plates.
- Available in Ivory, White, Brown, Gray, Black, Blue, Orange, Red, and Light Almond.
- Preferred for hospital, industrial, institutional, and other high-abuse applications.
- Nominal thickness, .070"

Screwless Polycarbonate Wall Plates

- Molded of .065" thick polycarbonate, matte finish.
- 2-piece plastic subplate made of polycarbonate.
- Extra 1/8" width and height than Standard size plates.
- Available in Ivory, White, Brown, Gray, Black, and Light Almond; and three metallic finishes.

Metal Wall Plates

- Constructed of corrosion-resistant stainless steel, brass, aluminum, chrome, brushed bronze or galvanized steel.
- Standard, Jumbo, and Tandem size plates available, as well as special Panel size plates up to 5-gangs high and 10-gangs wide.
- Packaged in protective film, with finish-matching screws.
- Variety of special plated finishes. Paintable to match plastic plates.
- Can be silk-screened or engraved, and custom punched with over 300 opening styles.

Materials

- Type 302/304 Stainless Steel, non-magnetic, .032" nominal thickness, brushed finish. This alloy contains 18% chromium and 8% nickel for superior resistance to corrosion. Recommended for use in food processing plants, dairies, chemical plants, and other industrial, institutional, and commercial applications where corrosive atmospheres exist.
- Type 430 Stainless Steel, magnetic, .032" nominal thickness, brushed finish. Less corrosion-resistant than Type 302/304, but ideal for general service in high abuse applications in industrial plants, commercial, and institutional buildings.
- Chrome, Brushed and Polished Brass, .040" thick. 70% copper, 30% zinc alloy gives warm, appealing finish to modern decor as well as retrofit applications. Lacquered to prevent corrosion.
- Aluminum, .040" thick. Lustrous satin finish. Lacquered to prevent corrosion.
- Galvanized Steel. Used only for Handy Box Plates.
- Brushed Bronze, .040" thick. 90% copper, 10% zinc. Lacquered to prevent corrosion.

WALL PLATES

Dimensions



Standard Size Wall Plates

- Standard size wall plates for all applications.
- Best fit for surface mount boxes.
- Available in plastic and metal only.

Dimensions

1 gang	2.75" x 4.5"
2 gang	4.56" x 4.5"
3 gang	6.375" x 4.5"
4 gang	8.125" x 4.5"
5 gang	10" x 4.5"
6 gang	11.812" x 4.5"
7 gang	13.62" x 4.5"
8 gang	15.44" x 4.5"

TradeMaster® Wall Plates

- Extra 3/16" width and height than Standard size wall plates.
- Provide better sheet rock coverage with standard size appearance.
- Available in unbreakable nylon 6 construction only.
- Screws pre-installed in the duplex, toggle and decorator single gang plates.

Dimensions

1 gang	2.9375" x 4.6875"
2 gang	4.75" x 4.6875"
3 gang	6.563" x 4.6875"
4 gang	8.375" x 4.6875"
5 gang	10.188" x 4.6875"
6 gang	12" x 4.6875"

Screwless Polycarbonate Wall Plates

- Available in decorator openings.
- Extra 1/8" width and height than Standard size wall plates.
- Provide better sheet rock coverage with standard size appearance.
- Molded of .065" thick polycarbonate.
- 2-piece plastic subplate made of polycarbonate.
- Available in 3 metallic finishes and 6 standard colors.

Wall Plate Dimensions

1 gang	3.10" x 4.87"
2 gang	4.912" x 4.87"
3 gang	6.724" x 4.87"
4 gang	8.536" x 4.87"

Subplate Dimensions

1 gang	2.85" x 4.62"
2 gang	4.662" x 4.62"
3 gang	6.474" x 4.62"
4 gang	8.286" x 4.62"

Junior-Jumbo Wall Plates

- Extra 3/8" width and height than Standard size wall plates.
- Additional coverage for sheet rock gaps.
- Available in plastic and metal only.

Dimensions

1 gang	3.125" x 4.87"
2 gang	4.93" x 4.87"
3 gang	6.75" x 4.87"
4 gang	8.56" x 4.87"

TradeMaster® Jumbo Wall Plates

- Extra 3/16" width and height than Junior-Jumbo size wall plates.
- Provide additional coverage for sheet rock gaps, matching the appearance of the TradeMaster Plates.
- Available in unbreakable nylon 6 construction only.
- Screws pre-installed in the duplex, toggle, and decorator single gang plates.

Dimensions

1 gang	3.3125" x 5.0625"
2 gang	5.125" x 5.0625"
3 gang	6.9375" x 5.0625"
4 gang	8.75" x 5.0625"

Jumbo Wall Plates

- Extra 3/4" width and height than Standard size wall plates.
- Largest size wall plates to cover larger wall damage.
- Available in plastic and metal only.

Dimensions

1 gang	3.5" x 5.25"
2 gang	5.31" x 5.25"
3 gang	7.12" x 5.25"
4 gang	8.93" x 5.25"

WALL PLATES

Dimensions

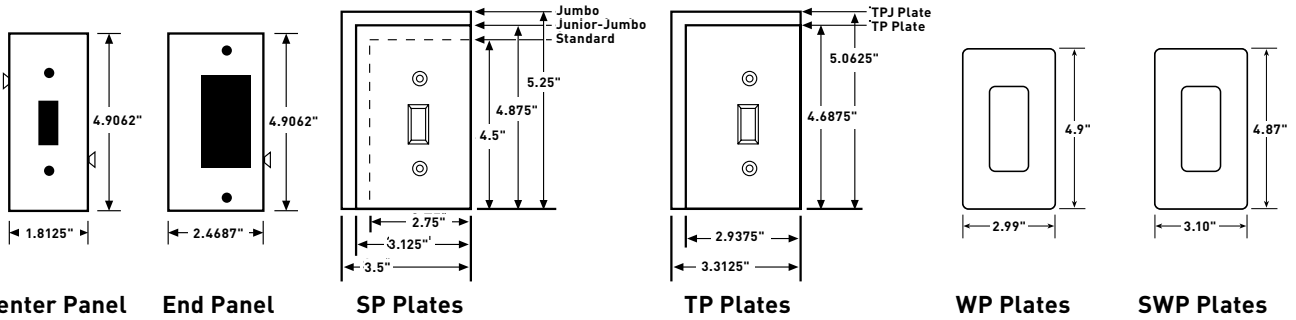

Sectional Wall Plates

End and center panels with each of five most-used configurations make it possible to improvise custom wall plates on the job. Panels lock securely together on installation. Blank sections furnished with mounting strap.

Wall Plate Mountings

Illustrated are the five standard methods of plate mounting. There are many other non-standard methods which depend upon the special device used. Exact mounting hole specifications for every device appear in the Selector Guide.

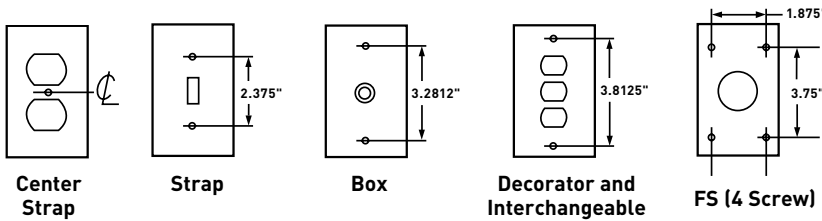



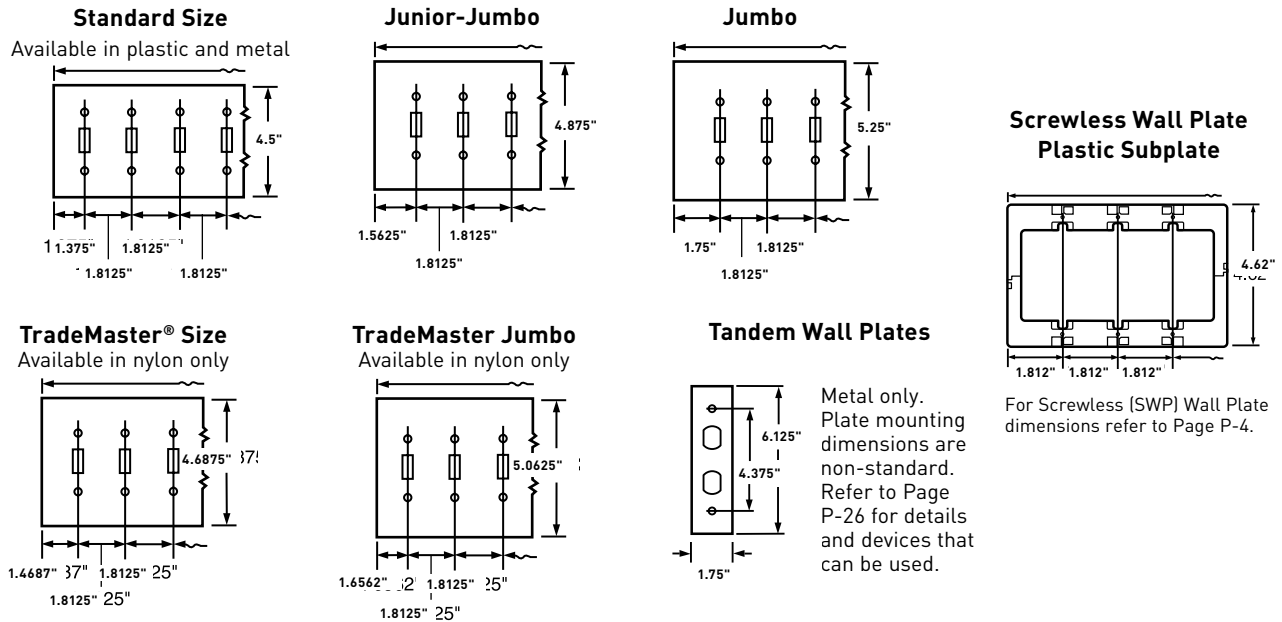





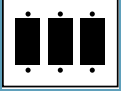

Wall Plate Sizes

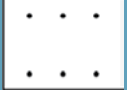

WALL PLATES

Decorator Openings & Blank Plates Junior-Jumbo & Jumbo Plastic & Metal

DESCRIPTION	NYLON			THERMOSET		METAL	
	COLOR	TRADEMASTER®	JUNIOR-JUMBO	JUMBO	MATERIAL	JUNIOR-JUMBO	JUMBO
		JUMBO	SMOOTH	SMOOTH		SMOOTH	SMOOTH
DECORATOR OPENINGS							
One Gang 	Ivory	TPJ26I	SPJ26I	SP026I	302/304 S/S	SSJ26	SB026 SS026
	White	TPJ26W	SPJ26W	SP026W			
	Brown	TPJ26	SPJ26	SP026			
	Gray	TPJ26GRY					
	Light Almond	TPJ26LA	SPJ26LA	SP026LA			
Two Gang 	Ivory	TPJ262I	SPJ262I	SP0262I	302/304 S/S	SSJ262	SS0262
	White	TPJ262W	SPJ262W	SP0262W			
	Brown	TPJ262	SPJ262	SP0262			
	Gray	TPJ262GRY					
	Light Almond	TPJ262LA	SPJ262LA				
Three Gang 	Ivory	TPJ263I	SPJ263		302/304 S/S	SSJ263	
	White	TPJ263W	SPJ263W				
	Brown	TPJ263	SPJ263				
	Gray	TPJ263GRY					
	Light Almond	TPJ263LA	SPJ263LA				
Four Gang 	Ivory	TPJ264I	SPJ264I				
	White	TPJ264W	SPJ264W				
	Brown	TPJ264	SPJ264				
	Gray	TPJ264GRY					
	Light Almond	TPJ264LA	SPJ264LA				
BLANK PLATES - BOX & STRAP MOUNTED							
One Gang Blank Box Mtd. 	Ivory	TPJ13I	SPJ13I	SP013I	302/304 S/S	SSJ13	SS013
	White	TPJ13W	SPJ13W	SP013W			
	Brown	TPJ13	SPJ13	SP013			
	Gray	TPJ13GRY					
	Light Almond	TPJ13LA	SPJ13LA				
Two Gang Blank Box Mtd. 	Ivory			SP023I	302/304 S/S		SS023
	White			SP023W			
	Brown			SP023			
Three Gang Blank Box Mtd. 					302/304 S/S		SS033
One Gang Strap Mtd. 					302/304 S/S		SS014
Two Gang Blank Strap Mtd. 					302/304 S/S		SS024
Three Gang Blank Strap Mtd. 					302/304 S/S		SS034

DEVICES & WALL PLATES

Color Selection Chart

Devices & Plastic Wall Plate Colors

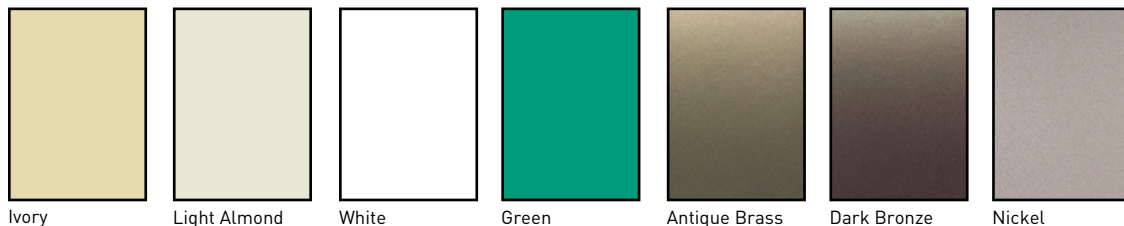

Ivory Light Almond White Green Antique Brass Dark Bronze Nickel

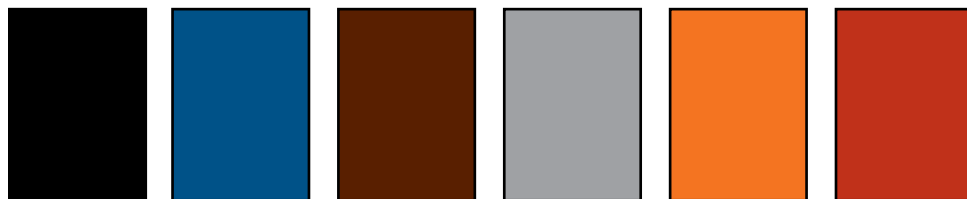

Black Blue Brown Gray Orange Red

See specific device and wall plate catalog charts for particular color availabilities.

Metal Wall Plates

Metal Finish

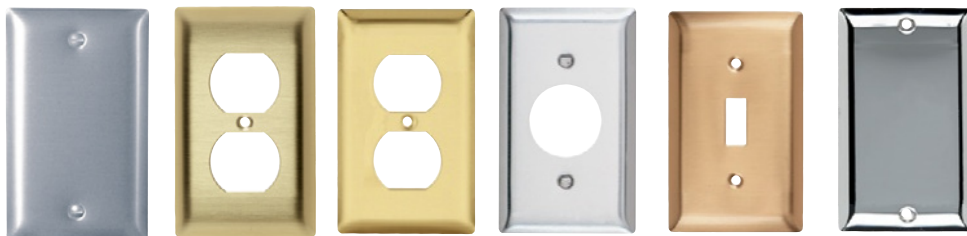

Aluminum Brass (Brushed) Polished Brass Stainless Steel Brushed Bronze Chrome

Custom Metal Wall Plates Paint Finish Colors

Paint Color

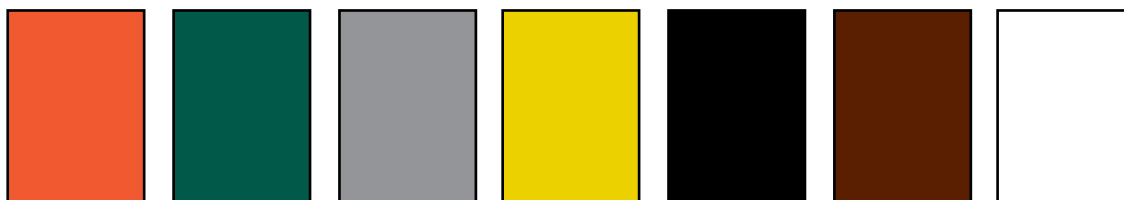

Orange Green Gray Yellow Glossy Black Brown White



Primer Red Pink Flat Black Ivory Light Almond Blue

To order custom metal wall plates, see Pages P-40 – P-42.
For additional colors consult factory.

WALL PLATES