

STRAIGHT BLADE RECEPTACLES

Power Outlet Receptacles & Plugs 20, 30, 50, & 60A

RATING		RECEPTACLE/PLUG CONFIGURATION & NEMA NO.						
A.	V.		FLUSH RECEPTACLE	WALL PLATE <small>*For 2 screw mounting **For 4 screw mounting</small>	SURFACE RECEPTACLE	PLUG	ANGLE PLUG	CONNECTOR
			CATALOG NUMBERS					
2 POLE, 3 WIRE GROUNDING								
30	125	5-30		3802 § AL/CU	1-Gang: TP724* 2-Gang: SS702* 2-Gang: TP703**		D0531 .57"-1.26"	D0533 .57"-1.26"
30	125	NEMA TT30		3830 AL/CU	1-Gang: TP724* 2-Gang: SS702* 2-Gang: TP703**			
For recreational vehicles.								
30	250	6-30		3801 AL/CU	1-Gang: TP724* 2-Gang: SS702* 2-Gang: TP703**		D0631 .57"-1.26"	3869 D0633 .57"-1.26"
50	125	5-50					D0551 .57"-1.26"	D0553 .57"-1.26"
50	250	6-50		3804 § AL/CU	1-Gang: TP724* 2-Gang: SS702* 2-Gang: TP703**	3852 # AL/CU	D0651 .57"-1.26"	3869 D0653 .57"-1.26"
3 POLE, 3 WIRE NON-GROUNDING								
30	125/250 Dryer	10-30		3860 AL/CU	1-Gang: TP724* 2-Gang: SS702* 2-Gang: TP703**	388 AL/CU	1031	3861
50	125/250 Range	10-50		3890 § AL/CU	1-Gang: TP724* 2-Gang: SS702* 2-Gang: TP703**	385 AL/CU	1051 .57"-1.26"	3861 1053 .32"-1.91"
3 POLE, 4 WIRE GROUNDING								
20	125/250	14-20		3820	1-Gang: SS7*			
30	125/250 Dryer	14-30		3864 AL/CU 3864NA †	2-Gang: SS702* 2-Gang: TP703**	3884 #/388440‡ AL/CU	1431 .57"-1.26"	5746AN 3867
30	3ø, 250	15-30		5740 AL/CU	2-Gang: SS702* 2-Gang: TP703**			5741AN
50	125/250 Range	14-50		3894 § AL/CU 3894NA †	2-Gang: SS702* 2-Gang: TP703**	3854 #/385440‡ AL/CU	1451 .57"-1.26"	5745AN 3867
50	3ø, 250	15-50		5750 AL/CU	2-Gang: SS702* 2-Gang: TP703**			5751AN
60	3ø, 250	15-60		5760 AL/CU	2-Gang: SS702* 2-Gang: TP703**		8462N	5761AN
4 POLE, 4 WIRE NON-GROUNDING								
20	3øY, 120/208	18-20		3822	1-Gang: SS7*		7251DF .35"-1.05"	
60	3øY, 120/208	18-60		3870 § AL/CU	2-Gang: SS701**		D1861 .57"-1.26"	8302AN

‡ In bulk pack of 40 with plastic snap-in wire clamp.

§ Up to #3 AWG aluminum conductors.

Up to #4 AWG aluminum conductors.

For further information consult Wall Plate Section P (for Stainless Steel versions of TP724 and TP703, refer to Pages P-14 and P-15).

† NAFTA-Compliant Receptacles are ideal for use on projects subject to the provisions of the Buy American Act.

All devices listed on this page conform to NEMA WD-1 and WD-6.

STRAIGHT BLADE RECEPTACLES

Power Outlet Receptacles & Plugs 20, 30, 50, & 60A

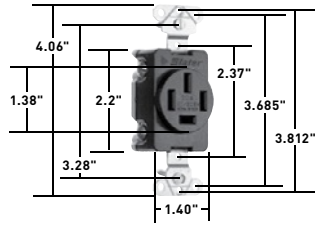

3822

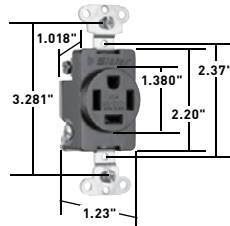

3820



385 3854
388 3884
3852

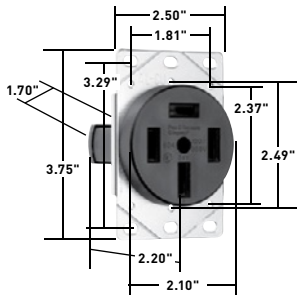

3870

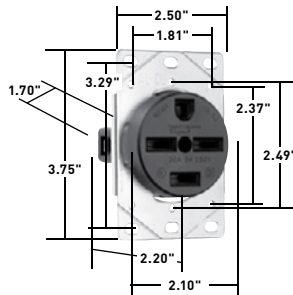

3801 3802
3804 3864
3894 5740
5750 5760

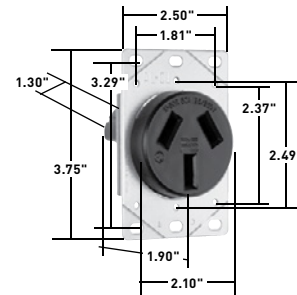

3830
3860
3890

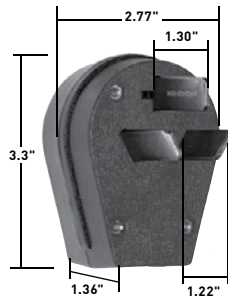

3861

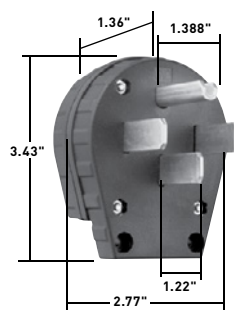

3867

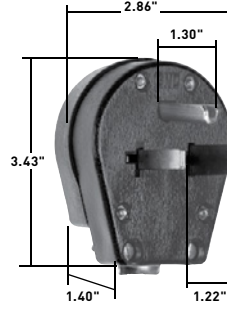

3869

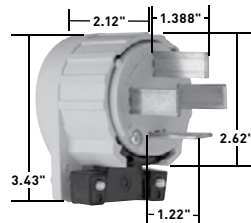

5741AN 5751AN
5745AN 5761AN
5746AN 8302AN

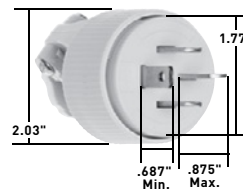

7251DF

STRAIGHT BLADE RECEPTACLES

STRAIGHT BLADE PLUGS & CONNECTORS

IP20
Suitability

Miscellaneous Configurations

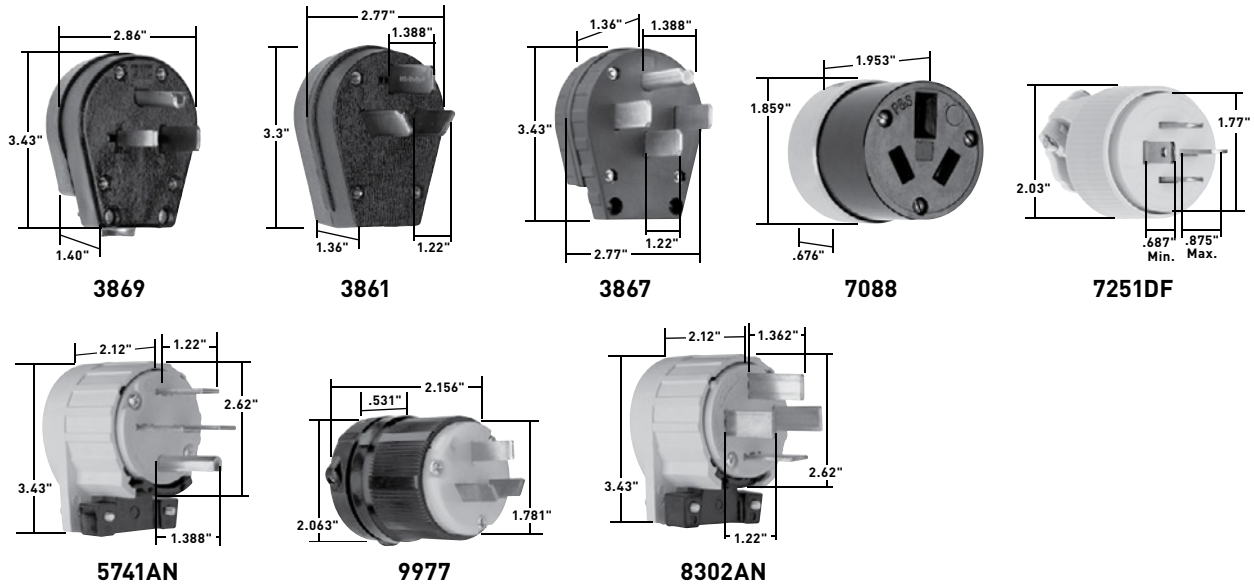

CATALOG NUMBER	RATING		DESCRIPTION	CORD DIAMETER	NEMA CONFIG. NO.	3rd PARTY COMPLIANCE		
	A.	V.				UL498	FSUL WC596	CSA C22.2 No. 42
2 POLE, 3 WIRE GROUNDING								
43379	30	125	Angled Plug, Yellow		5-30P	•		
43399	50	125	Angled Plug, Yellow		5-50P	•		
3869	30/50	250	Angled Plug, Black	.56"-1.1"	6-30P/6-50P	•		
3 POLE, 3 WIRE NON-GROUNDING								
3861	30/50	125/250	Angled Plug, Black	.56"-1.1"	10-30P/10-50P	•		•
9977	20	125/250	Plug, Nylon		10-20P	•		
7088	20	125/250	Connector, Armored		10-20R			
3 POLE, 4 WIRE GROUNDING								
5746AN	30	125/250	Angled Plug, Yellow		14-30P	•		•
5741AN	30	3ø, 250	Angled Plug, Yellow		15-30P	•		•
5745AN	50	125/250	Angled Plug, Yellow		14-50P	•		•
14629	60	125/250	Angled Plug, Yellow		14-60P	•		•
5751AN	50	3ø, 250	Angled Plug, Yellow		15-50P	•		•
5761AN	60	3ø, 250	Angled Plug, Yellow		15-60P	•		•
3867	30/50	125/250	Angled Plug, Black	.56"-1.1"	14-30P/14-50P	•		•
4 POLE, 4 WIRE NON-GROUNDING								
7251DF	20	3øY, 120/208	Plug, Yellow	.365"-.775"	18-20P	•	•	
8302AN	60	3øY, 120/208	Angled Plug, Yellow		18-60P	•		

