



Pass & Seymour

# Turnlok® Locking Devices Heavy-Duty Receptacles 15, 20 & 30A; 125 & 250V, 277VAC

4710, 4700, 4792, 4560, 4550, 4760, 4750, L520, CRL520, L620, L720, L530, CRL530, L630, L730

## Quality construction for maximum durability.

**C**hoose from a broad range of capacities in both single and duplex receptacle designs. They feature high-quality, brass contacts for rock-solid electrical connections and long service life. Single-piece, solid brass or steel straps and impact-resistant nylon face and body help them shrug off hard use.



### Features & Benefits

**Compact, impact-resistant nylon face and body** are ultrasonically welded together for unrivaled strength.

**One-piece, high-grade brass contacts** offer excellent conductivity and heat-rise resistance.

**Side and external screw-pressure-plate back wire capability.** Accepts #14 — #10 AWG.



**Clearly marked NEMA configuration, rating and third party listing** on each unit's face.

**Single-piece, solid brass mounting strap** is free of easily loosened rivets found on other brands. 15 Amp mounting strap is steel.

### Field Uses/Vertical Markets

- Industrial
- Health Care
- Education
- Institutional
- Retail
- Office
- Hospitality/Lodging



Pass & Seymour

# Turnlok® Locking Devices Heavy-Duty Receptacles 15, 20 & 30A; 125 & 250V, 277VAC

## Ordering Information

Catalog Number	Rating A. V.	Description/Color	NEMA Config. No.
<b>Receptacles Back &amp; Side Wire</b>			
4710	15 125	Single Receptacle	L5-15R
4700	15 125	Duplex Receptacle	L5-15R
4792	15 125	Combination Straight Blade and Locking	5-15R and L5-15R
4560	15 250	Single Receptacle	L6-15R
4550†	15 250	Duplex Receptacle	L6-15R
4760	15 277*	Single Receptacle	L7-15R
4750	15 277*	Duplex Receptacle	L7-15R
L520-R	20 125	Single Receptacle	L5-20R
CRL520-R	20 125	Single Receptacle, Corrosion-Resistant	L5-20R
L620-R	20 250	Single Receptacle	L6-20R
L720-R	20 277*	Single Receptacle	L7-20R
L530-R	30 125	Single Receptacle	L5-30R
CRL530-R	30 125	Single Receptacle, Corrosion-Resistant	L5-30R
L630-R	30 250	Single Receptacle	L6-30R
L730-R	30 277*	Single Receptacle	L7-30R

\*AC only.

†Not designed for split circuits.

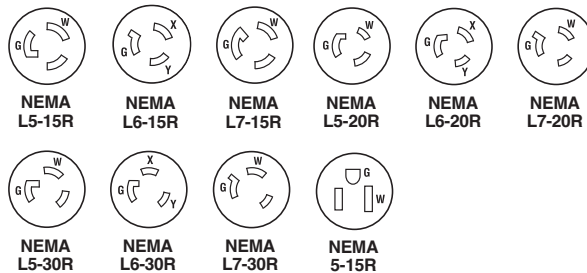

For more information on these and other P&S products refer to our Product Guide or visit our web site.

# Turnlok® Locking Devices Heavy-Duty Receptacles 15, 20 & 30A; 125 & 250V, 277VAC



Pass & Seymour

## Technical Specifications

### 3rd Party Compliance

UL Listed, File Number E146159, Standard UL498, Attachment Plugs and Receptacles.  
Federal Specification WC596.  
CSA Certified, File Number LR1765, Standard CSA-C22.2 No. 42, General Use Receptacles and Attachment Plugs.  
Conforms to NEMA WD-1.

### Performance

Electrical	
Dielectric Withstand Voltage	2000V minimum
Maximum Working Voltage	600VAC
Current Interrupting	Certified for current interrupting at full-rated current
Temperature Rise	30°C max. after 50 cycles at 150% rated current

Mechanical	
Terminal Accommodation	#14 AWG min. – #10 AWG max.
Product Identification	Amperage, Voltage, NEMA Configuration molded into face

Environmental	
Flammability	UL94 V2
Operating Temperature	Maximum continuous +75°C, minimum -40°C without impact

### Materials

	Standard	Corrosion-Resistant
Front Body	Nylon	Nylon
Back Body	Nylon	Nylon
Mounting Strap	15A = Steel, 20 & 30A = Brass	Nickel-Plated Brass
Pressure Plate	Brass	Nickel-Plated Brass
Contacts	Brass	Nickel-Plated Brass
Terminal Clamps	Brass	Nickel-Plated Brass
Terminal Screws	Brass	Brass
Mounting Screws	Zinc-Plated Steel	Stainless Steel

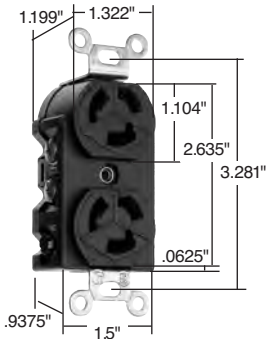

Dimensions for 4700

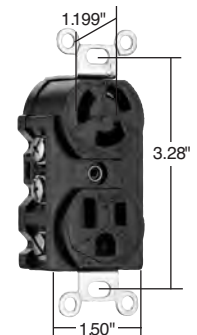

Dimensions for 4792

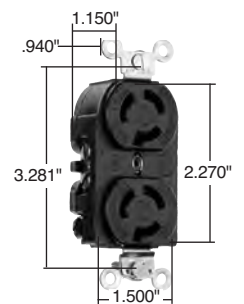

Dimensions for 4550

### Warranty

1 Year

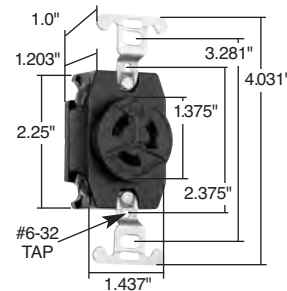

Dimensions for 4760

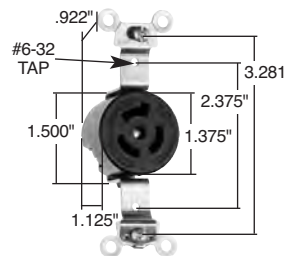

Dimensions for 4560

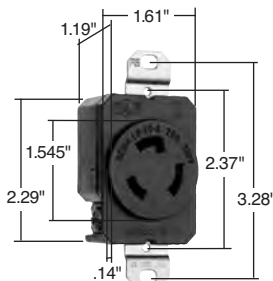

Dimensions for 20 Amp Receptacle

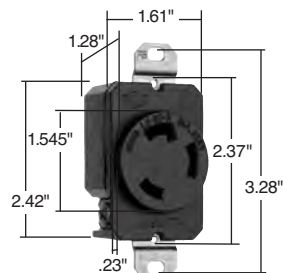

Dimensions for 30 Amp Receptacle

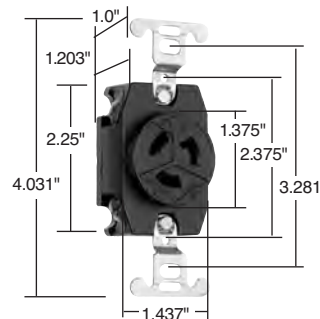

Dimensions for 4710

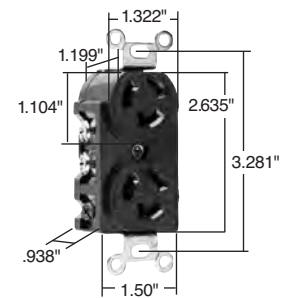

Dimensions for 4750

## Complementary Devices & Accessories



### TURNLOK® LOCKING DEVICES

- Extra-Hard Use Plugs & Connectors
- Heavy-Duty Flanged Inlets & Outlets



### GROUND CONTINUITY MONITORING (GCM)

- Extra-Hard Use Straight Blade
- Heavy-Duty Turnlok®



### STRAIGHT BLADE PLUGS & CONNECTORS

- Extra-Hard Use
- Heavy-Duty MaxGrip® II

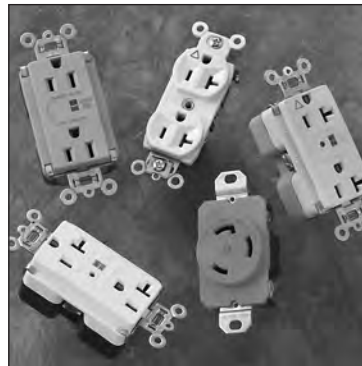

### TVSS & ISOLATED GROUND DEVICES

- Construction Grade Isolated Ground
- Heavy-Duty Turnlok® Isolated Ground
- Heavy-Duty Isolated Ground TVSS
- Heavy-Duty TVSS
- Construction Grade TVSS



### WALL PLATES

- TradeMaster® Thermoplastic Nylon
- Stainless Steel
- Brass
- Aluminum
- Dustproof Stainless Steel Covers

## Also available...

- Light Almond Devices
- Decorator Devices
- Hospital Grade Devices
- PlugTail™ Devices
- Switches
- Straight Blade Receptacles
- GFCIs
- Weatherproof Boxes & Covers
- IEC 309 Industrial Products
- Flexcor® Wire Mesh Grips
- Configurable Solutions



**Legrand/Pass & Seymour**  
P.O. Box 4822  
Syracuse, NY 13221-4822  
800-223-4185

**North America Headquarters**  
60 Woodlawn Street  
West Hartford, CT 06110  
Phone: 1.877.BY.LEGRAND (295.3472)  
Fax: 1.860.232.2062  
www.legrand.us

**Legrand Canada**  
570 Applewood Crescent  
Vaughan, ON, L4K 4B4  
Phone: 905.738.9195  
Fax: 905.738.9721  
www.legrand.ca