



CONDENSING GAS COMBI BOILER



Owner's Guide

Models

CB199-DV / CB180-DV
Natural Gas(NG) / Liquid Propane Gas(LP)

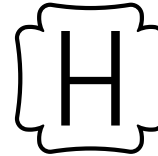

Low NOx Approved
by SCAQMD
14ng/J or 20ppm
(Natural Gas Only)

Thank you for purchasing this Noritz Condensing Gas Combi Boiler.
Before using, please:
Read this guide completely for operation instructions.
Completely fill out the warranty registration card (included separately) and mail the detachable portion to Noritz America Corporation. Keep this guide (and the remainder of the warranty registration card) where it can be found whenever necessary.
Installation must conform with local codes, or in the absence of local codes, the National Fuel Gas Code, ANSI Z223.1/NFPA 54-latest edition and/or, Natural Gas and Propane Installation Code (CSA B149.1-latest edition). Where required by the authority having jurisdiction, the installation must conform to the Standard for Controls and Safety Devices for Automatically Fired Boilers, ANSI/ASME CSD-1. Noritz America reserves the right to discontinue, or change at any time, the designs and/or specifications of its products without notice.

WARNING

If the information in these instructions is not followed exactly, a fire or explosion may result, causing property damage, personal injury, or death.

- Do not store or use gasoline or other inflammable vapors and liquids in the vicinity of this or any other appliance.
- WHAT TO DO IF YOU SMELL GAS
 - Do not try to light any appliance.
 - Do not touch any electrical switch; do not use any phone in your building.
 - Immediately call your gas supplier from a neighbor's phone. Follow the gas supplier's instructions.
 - If you cannot reach your gas supplier, call the fire department.
- Installation and service must be performed by a qualified installer, service agency or the gas supplier.

Owner's Guide – Table of Contents

| | | | |
|-------------------------|---------------------------|--|----------|
| <u>Chapter 1</u> | Product Overview | Operation Flow Chart | 3 |
| <u>Chapter 2</u> | Safety Regulations | Safety Precautions | 4 |
| | | Before Operation | 7 |
| | | During Operation | 9 |
| | | Important Safety Information | 11 |
| <u>Chapter 3</u> | Unit Operation | Initial Operation | 12 |
| | | Control Panel Interface | 13 |
| | | Control Panel LCD Interface | 14 |
| | | How to use Control Panel | |
| | | 1. Clock Setting | 15 |
| | | 2. Setting Domestic Hot Water Temperature(DHW) | 17 |
| | | 3. DHW Preheat Activated Setting | 18 |
| | | 4. DHW Preheat Timer Setting | 19 |
| | | 5. Setting Heating Temperature | 21 |
| | | • User Mode | 22 |
| | | 6. Lock Mode | 23 |
| | | 7. Error History | 23 |
| | | 8. Running History | 24 |
| | | 9. Unit Setting | 25 |
| | | 10. Preventing Damage from Freezing-1 | 26 |
| | | 11. Preventing Damage from Freezing-2 | 29 |
| <u>Chapter 4</u> | Maintenance | 1. General Maintenance | 30 |
| | | 2. Cleaning the Combi Boiler | 31 |
| | | 3. Flushing the Combi Boiler | 33 |
| | | 4. Checking for Error Conditions | 34 |
| <u>Chapter 5</u> | Troubleshooting | Troubleshooting | 35 |
| <u>Chapter 6</u> | Follow-up Service | Follow-up Service | 36 |
| | Memo | | 37 |

Operation Flow Chart

Domestic Hot Water Mode (DHW Mode)

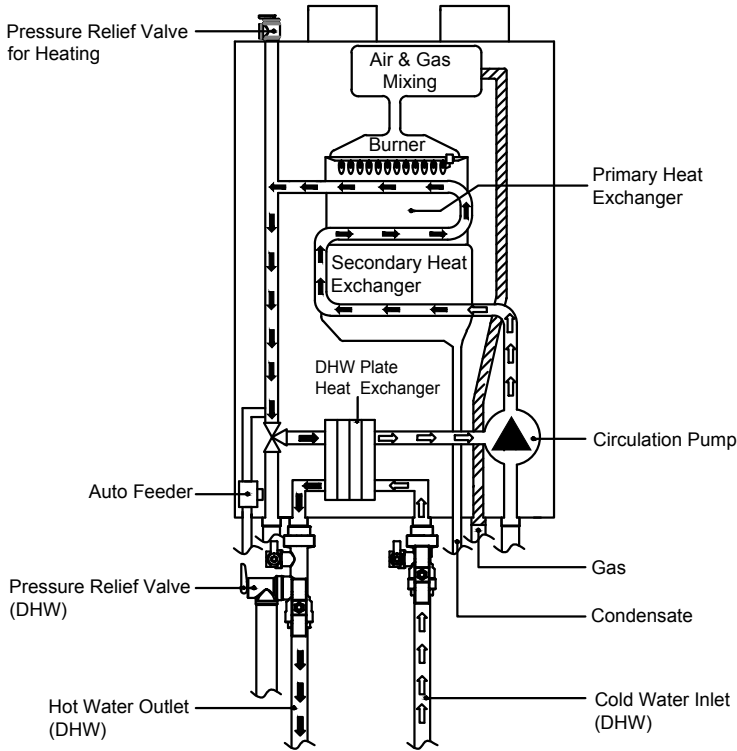

The Condensing Gas Combi Boiler discharges condensate.

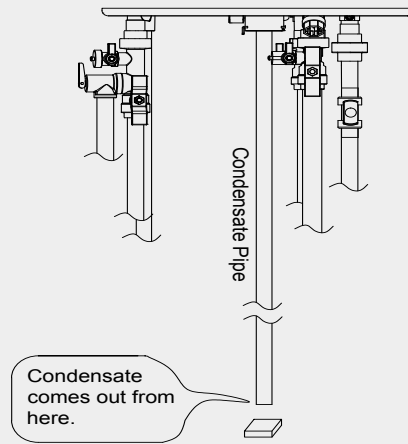

When heat from the exhaust gas is collected within the secondary heat exchanger, condensation occurs from moisture in the exhaust gas and the resulting water is discharged from the drain pipe (approx. 2 gallons/hour (7.5 liters/hour) maximum). It is not a water leak. Do not plug or block the drain line as it must always be allowed to freely flow.

Note: The condensate discharged is acidic with a pH level of approximately 2-3. A condensate neutralizer may be required by local code prior to disposal.

Heating Mode

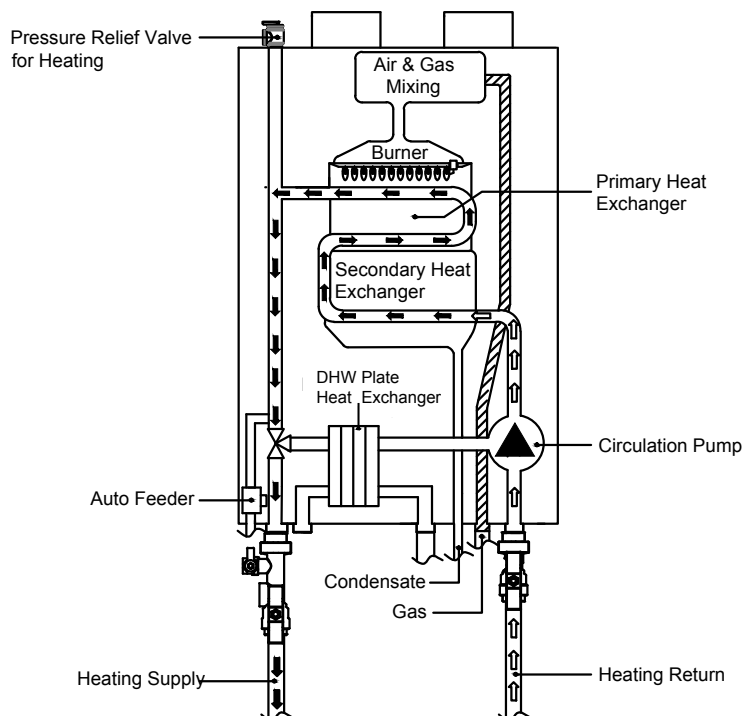

Safety Precautions

To avoid product damage, personal injury, or even possible death, carefully read, understand, and follow all the instructions in the Installation Manual and Owner's Guide and on the Combi Boiler before installation, operation, or service.

Noritz cannot anticipate every circumstance that might involve a potential hazard and our warnings are, therefore, not all-inclusive. Proper installation, operation, and service are your responsibility.

You must be satisfied that the operation and settings of the Combi Boiler are safe for you and for others.

Safety Symbols are provided in the guide. When a user fails to adhere to the following requirements, it can cause death, serious damage, and a great property loss. For safety symbols, 'DANGER', 'WARNING', 'CAUTION' are indicated and the definitions for these terms are below :

DANGER

Indicates an imminently hazardous situation which, if not avoided, will result in death or serious injury. This signal word is limited to the most extreme situations.

WARNING

Indicates a potentially hazardous situation which, if not avoided, could result in death or serious injury.

CAUTION

Indicates a potentially hazardous situation which, if not avoided, may result in minor or moderate injury. It is also used to alert against unsafe practices and hazards involving only property damage.

WARNING

FOR YOUR SAFETY READ BEFORE OPERATING

If you do not follow these instructions exactly, a fire or explosion could result causing property damage, personal injury or loss of life.

- A. This appliance does not have a pilot. It is equipped with an ignition device which automatically lights the burner. Do not try to light the burner by hand.
- B. BEFORE OPERATING smell all around the appliance area for gas. Be sure to smell next to the floor because some gas is heavier than air and will settle on the floor.

WHAT TO DO IF YOU SMELL GAS

- Do not try to light any appliance.
 - Do not touch any electric switch; do not use any phone in your building.
 - Immediately call your gas supplier from a neighbor's phone. Follow the gas supplier's instructions.
 - If you cannot reach your gas supplier, call the fire department.
- C. Use only your hand to push in or turn the gas control knob. Never use tools. If the knob will not push in or turn by hand, don't try to repair it, call a qualified service technician. Force or attempted repair may result in a fire or explosion.
 - D. Do not use this appliance if any part has been under water. Immediately call a qualified service technician to inspect the appliance and to replace any part of the control system and any gas control which has been under water.

WARNING

TO TURN OFF GAS TO APPLIANCE

1. Set the thermostat to lowest setting.
2. Turn off all electric power to the appliance if service is to be performed.
3. Turn manual gas shutoff valve to "OFF" position

Safety Precautions

⚠ WARNING

OPERATING INSTRUCTIONS

1. STOP! Read the safety information on previous page.
2. Set the thermostat to lowest setting.
(Do not use Combi Boiler unless it is completely filled with water.)
3. Turn OFF electrical power supply to the Combi Boiler.
4. This Combi Boiler is equipped with an ignition device which automatically lights the main burner. Do not try to light the burner by hand.
5. Turn gas shut-off valve clockwise to "OFF" position. Do not force
6. Wait five (5) minutes to clear out any gas. If you then smell gas, STOP! Follow step "B" on previous page. If you don't smell gas, go to next step.
7. Turn manual gas shut-off valve to "ON" position.
8. Turn ON electrical power to the appliance.
9. Press and hold the 'Temperature Setting Button' for 5 seconds for Domestic Hot Water Temperature Setting.
10. Factory Default Domestic Hot Water Temperature (120°F) is displayed. Set the desired Domestic Hot Water Temperature.
11. Turn Domestic Hot Water faucet on.
12. Set thermostat to desired setting.
13. If the appliance will not operate, follow the instructions "To Turn Off Gas To Appliance on previous page and call your service technician or gas supplier.

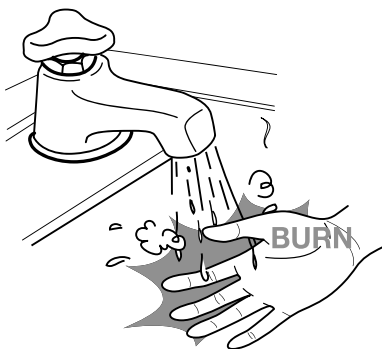

⚠ DANGER

Use this Combi Boiler at your own risk. The outlet temperature of the Noritz Combi Boiler is factory preset to 120°F (49°C). The temperature can only be changed by using the control panel. Domestic Hot Water temperature over 125°F (52°C) can cause severe burns instantly or death from scalding. Children, disabled, and elderly are at the highest risk of being scalded. Do not leave children or the infants unsupervised. Check temperature of Domestic Hot Water before taking a shower or bath. To control water temperature to a particular faucet, temperature limiting valves can be installed by your service professional.

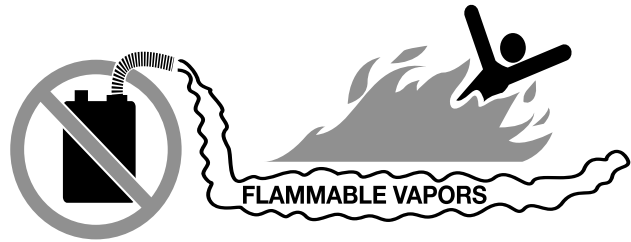

⚠ DANGER

- Vapors from flammable liquids will explode and catch fire causing death or severe burns.
- Do not use or store flammable products such as gasoline, solvents or adhesives in the same room or area near the appliance.

Keep flammable products :

- Far away from Combi Boiler
- In approved containers
- Tightly closed
- Out of children's reach

Vapors

- Cannot be seen
- Vapors are heavier than air
- Go a long way on the floor
- Can be carried from other rooms to the main burner by air currents

Do not install the appliance where flammable products will be stored. Read and follow Combi Boiler warnings and instructions. If Owner's Guide is missing contact the retailer or manufacturer.

Safety Precautions

⚠ WARNING

- Proper care is your responsibility. Carefully read and understand the Operating Information in this guide before operating the Noritz Combi Boiler.
- Be fully aware of where the gas shut-off valve is located and how to operate it. Close the gas shut-off valve immediately if the appliance is subjected to fire, overheating, flood, physical damage, or any other damaging condition that might affect the operation of the unit. The Combi Boiler must be checked by a qualified technician before resuming operation.
- DO NOT use this Combi Boiler if any part has been under water, call a qualified technician immediately for inspecting the Combi Boiler and for replacing any part of the control system and any gas control which has been under water.
- Do not power up the unit unless the gas and water supply valves are fully opened. Make sure that fresh air intake flue and exhaust gas flue are opened and functional.
- DO NOT attempt to install, repair, or service the Combi Boiler by yourself. Contact a qualified technician if the Combi Boiler needs repair or maintenance. Ask your gas supplier for a list of qualified service providers.
- “Verify proper operation after servicing operation”
- The gas ignition system components must be protected from water (dripping, spraying, rain, etc.) during appliance operation and service (circulator replacement, condensate trap, control replacement, etc.)

⚠ DANGER

Do not operate the Combi Boiler if its combustion air intake is located in or near one of the areas or in the vicinity of products listed in Table. These areas will always contain hazardous contaminants that can form strong acids while passing through the burner and vent system. These acids will corrode the Combi Boiler’s heat exchanger, burner components and vent system, resulting in flue gas spillage and/or water leakage, possible substantial property damage, severe personal injury, or death. If the Combi Boiler combustion air intake is located in any area likely to cause or contain contamination, or if products which would contaminate the air cannot be removed, the intake must be re-piped and terminated to another location.

| PRODUCTS TO AVOID | AREAS LIKELY TO HAVE CONTAMINANTS |
|---|--|
| Spray cans containing fluorocarbons | Dry cleaning/laundry areas and establishments |
| Permanent wave solutions | Swimming pools |
| Chlorinated waxes/cleaners | Metal fabrication plants |
| Chlorine-based swimming pool chemicals | Beauty shops |
| Calcium chloride used for thawing | Refrigeration repair shops |
| Sodium chloride used for water softening | Photo processing plants |
| Refrigerant leaks | Auto body shops |
| Paint or varnish removers | Plastic manufacturing plants |
| Hydrochloric or Muriatic acid | Furniture refinishing areas and establishments |
| Cements and glues | New building construction |
| Antistatic fabric softeners used in clothes dryers | Remodeling areas |
| Chlorine-type bleaches, laundry detergents, and cleaning solvents | Garages and workshops |

Before Operation

CAUTION

1. Check the gas being used.

When the Combi Boiler is used or moved for the first time, user must check whether the type of gas being supplied matches the specific gas type for the appliance. The type of gas is indicated on the rating plate on side of the Combi Boiler.



4. Check the water valve.

Please leave the appliance water supply valve open at all times (it must be closed during installation)

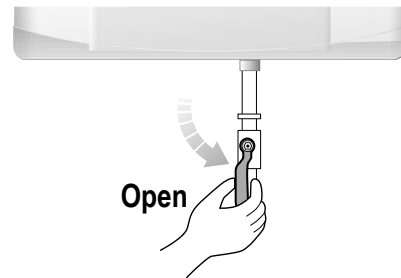

2. Check the electricity being supplied.

Please check whether the appliance is connected properly.

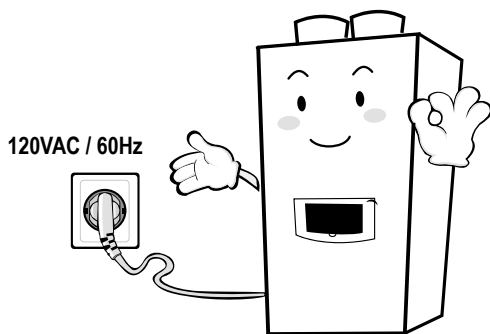

3. Check the gas valve.

Please confirm the gas valve connected to the Combi Boiler. (It must be closed during installation)

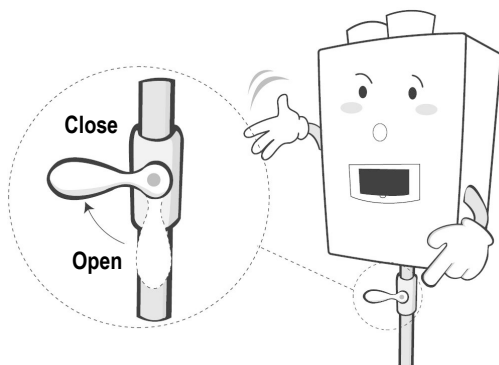

Before Operation

! WARNING

Do not store flammable material in the appliance room.

Do not store portable gas container, thinner, oil, or other flammable materials in the room. Otherwise, fire may break out.

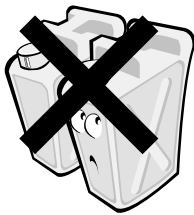

! CAUTION

Pull out the power plug from the receptacle if lightning strikes.

Lightning can damage the Combi Boiler. Pull out power cord plug if lightning strikes for your safety.

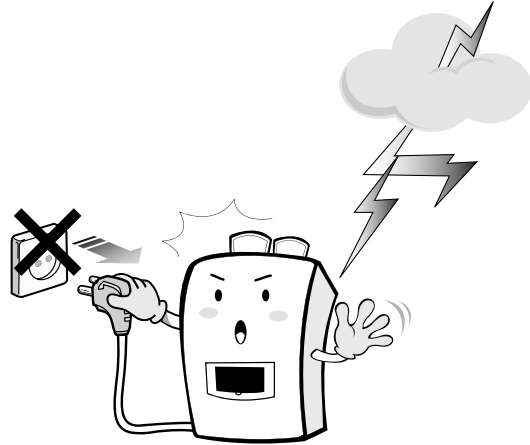

Do not place combustible items, such as newspapers or laundry, near the appliance or venting pipe.

Do not store combustible (flammable) materials such as papers. Do not hang clothes on the exhaust vent. Otherwise, fire may break out.

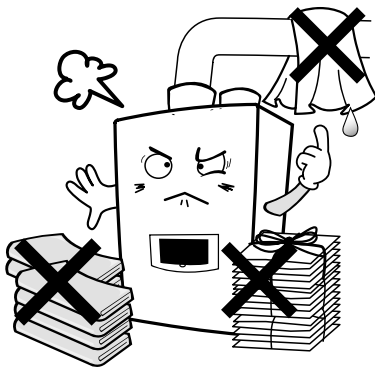

Burn Protection

Be cautious when opening the Domestic Hot Water tap.

The water may be very hot. Especially, children, disable and elderly are at the highest risk of being scalded.

(Freeze protection is unavailable if the unit is unplugged from power.)

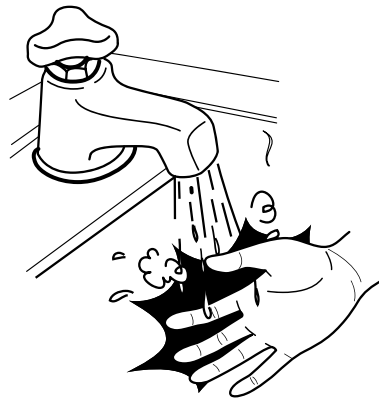

During Operation

⚠ CAUTION

▪ **After repair of gas pipeline or gas regulator replacement, call service agent for inspection before starting it up.**

Ventilation during gas leakage

If exhaust gas enters room, it could cause poisoning by carbon monoxide. Check if the exhaust pipe is connected properly. Open windows for ventilation at appropriate intervals.

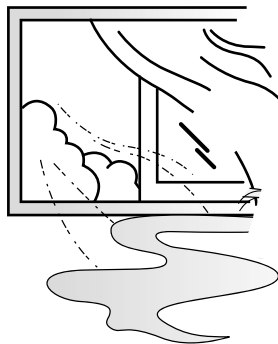

What to do if you smell gas

1. Do not try to light any appliance.
2. Do not touch any electrical switch; do not use any phone in your building.
3. Immediately call your gas supplier from a neighbor's phone. Follow the gas supplier's instructions.
4. If you cannot reach your gas supplier, call the fire department.

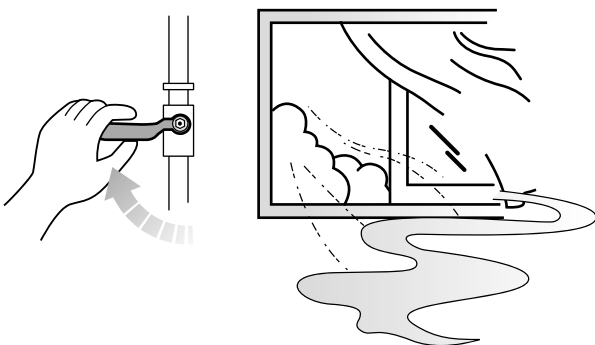

Gas leakage test

Gas supply line must be inspected regularly. (If air bubbles appear in soap water test, the gas is leaking out. Close the gas supply valve and call your gas supplier for inspection)

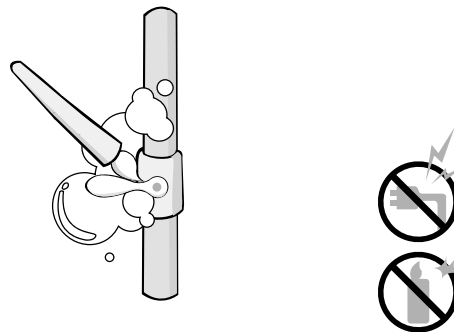

In cases where the pipes are frozen

Thaw the DHW Inlet, DHW Outlet, Heating Return and Heating Supply pipes with hair dryer or other electric heating device. If it does not work, Contact the installer or service agent for assistance.

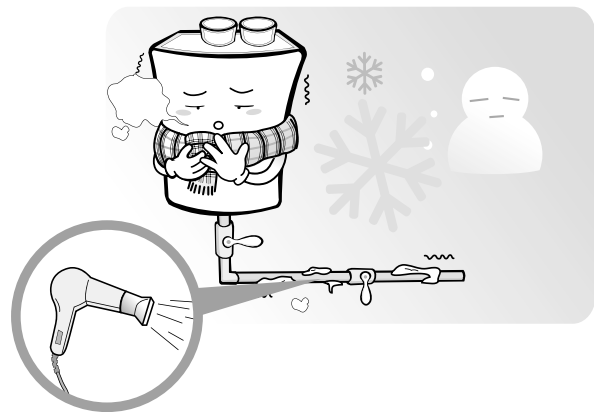

During Operation

⚠ CAUTION

Do not shut off the Combi Boiler.

When you leave home for a long time, do not shut off the Combi Boiler. The Combi Boiler has a freeze protection function. The freeze protection feature will not work if electrical power, gas, or water is disconnected.

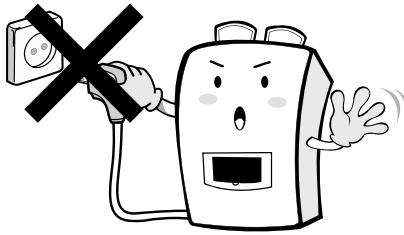

Do not disassemble the Combi Boiler.

Service must be performed by a qualified installer, service agency and gas supplier. Otherwise, Warranty will be voided.

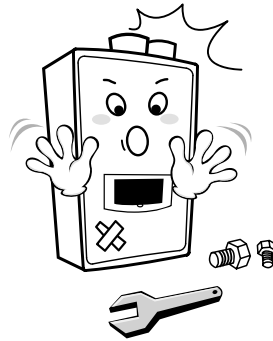

Do not wipe the appliance or control panel with wet cloth.

Otherwise, electric shock may occur, or internal parts may be deteriorated or failed due to the infiltration of moisture.

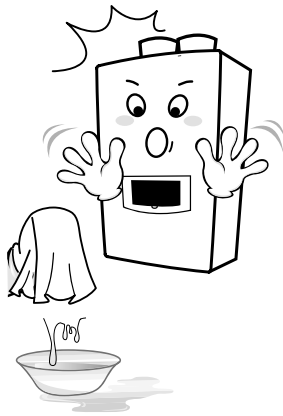

Burn Protection

Do not touch the exhaust vent, DHW Outlet, Heating Supply and Heating Return pipes during operation since they are very hot. Otherwise, the user may get burned.

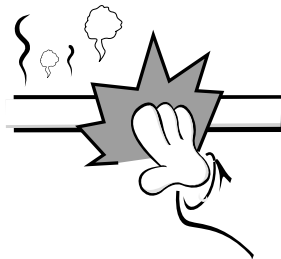

Important Safety Information**⚠ CAUTION**

- Do not drink water that has been inside the unit for an extended period of time.
Do not drink the first use of Domestic Hot Water from the unit in the morning.
- Clean the filter on the water inlet as frequently as required by the quality of your local water.
- Keep the area around the unit clean. If boxes, weeds, cobwebs, cockroaches etc. are in the vicinity of the unit, damage or fire can result.
- Do not install the equipment where the exhaust will blow on walls or windows.
- Problems resulting from scale formation are not covered by the warranty.
- Check ignition during use and extinction after use.
- Do not run water through the unit when unit is not on.
When discharging Domestic Hot Water , make sure the unit is ON.
If water is run through the unit with the unit OFF, water may condense inside the unit and cause incomplete combustion or damage to the internal electrical components.
- Preventing damage from freezing
Damage can occur from frozen water within the device and pipes even in warm environments.
Be sure to read below for appropriate measures. Repairs for damage caused by freezing are not covered by the warranty.
- Take necessary measures to prevent freezing of water and leakage of gas when leaving the unit unused for long periods of time.
- If it is snowing, check the intake and exhaust vent terminal for blockage.
- Do not use parts other than those specified for this equipment.

Initial Operation

• Before the first use of your Combi Boiler, make the following preparations.

1. Open the water pipe valve.

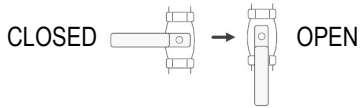

2. Open a hot water fixture/faucet to confirm that water is available, and then close the fixture/faucet again.

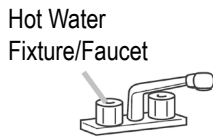

3. Open the gas supply valve.

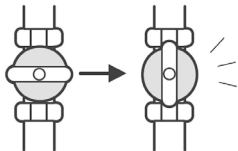

4. Turn on the control panel.

Do not touch with wet hands.

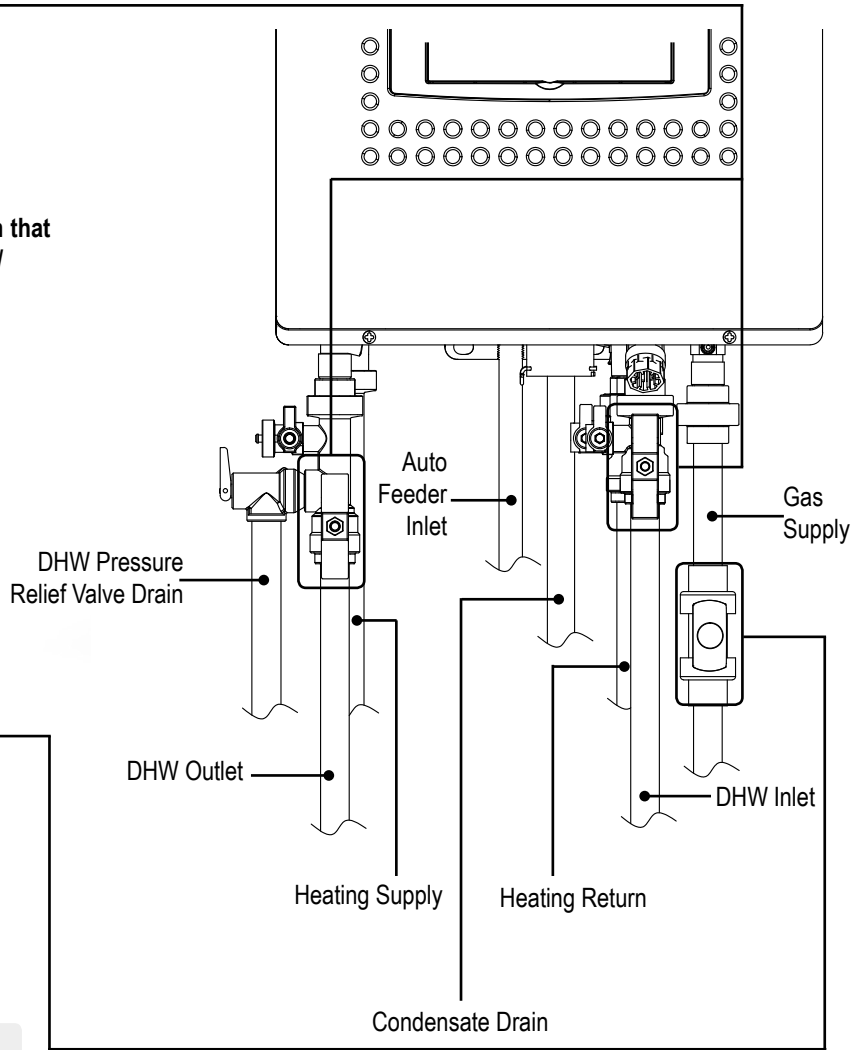

5. The unit starts auto feeding for heating. 'Error Code 54' will be indicated at the beginning of auto feeding. This is normal operation. When auto feeding is complete, 'Error Code 54' turns off automatically.

Control Panel Interface

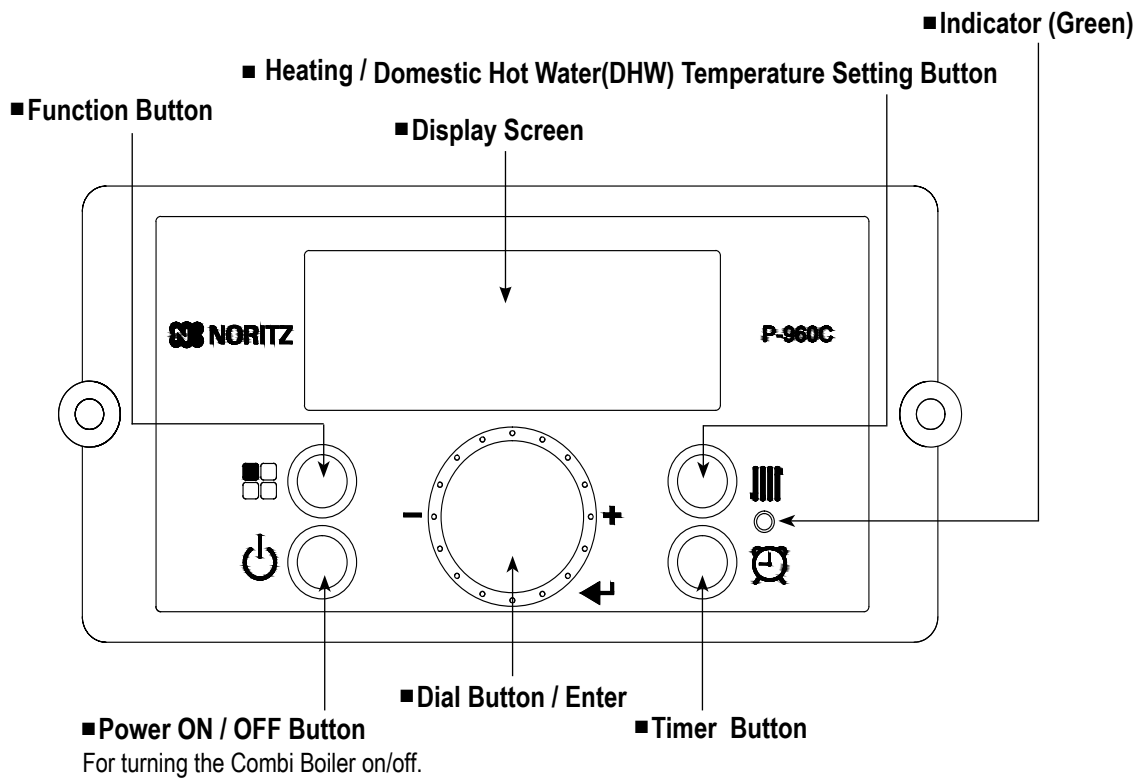

| Buttons | Functionality | |
|--|--|--|
| | Press (under 5 seconds) | Press and Hold (more than 5 seconds) |
| Power ON / OFF Button | Control Panel Power ON/OFF | N/A |
| Function Button | Cancel / Return | Status display mode at power ON mode. Installer Mode at power OFF mode. |
| Heating / Domestic Hot Water(DHW) Temperature Setting Button | Heating temperature setting mode 100°F~180°F (38°C~82°C) * Temperature range can be changed by using Installer Mode 1:HT | Domestic Hot water temperature setting mode 90°F~120°F (32°C~49°C) Domestic Hot water High temperature setting mode 121°F~140°F (49.5°C~60°C) |
| Timer Button | DHW Preheat timer setting | Time, Day, Month, Year, Days of the Week setting |
| Dial (Enter) Button | Menu and Value Up(+) / Down(-) | N/A |

Control Panel LCD Interface

- LCD has a backlight that will illuminate:
- When a user action is detected (a button is pressed).
 - Turns off when no action within approximately 2 minutes.

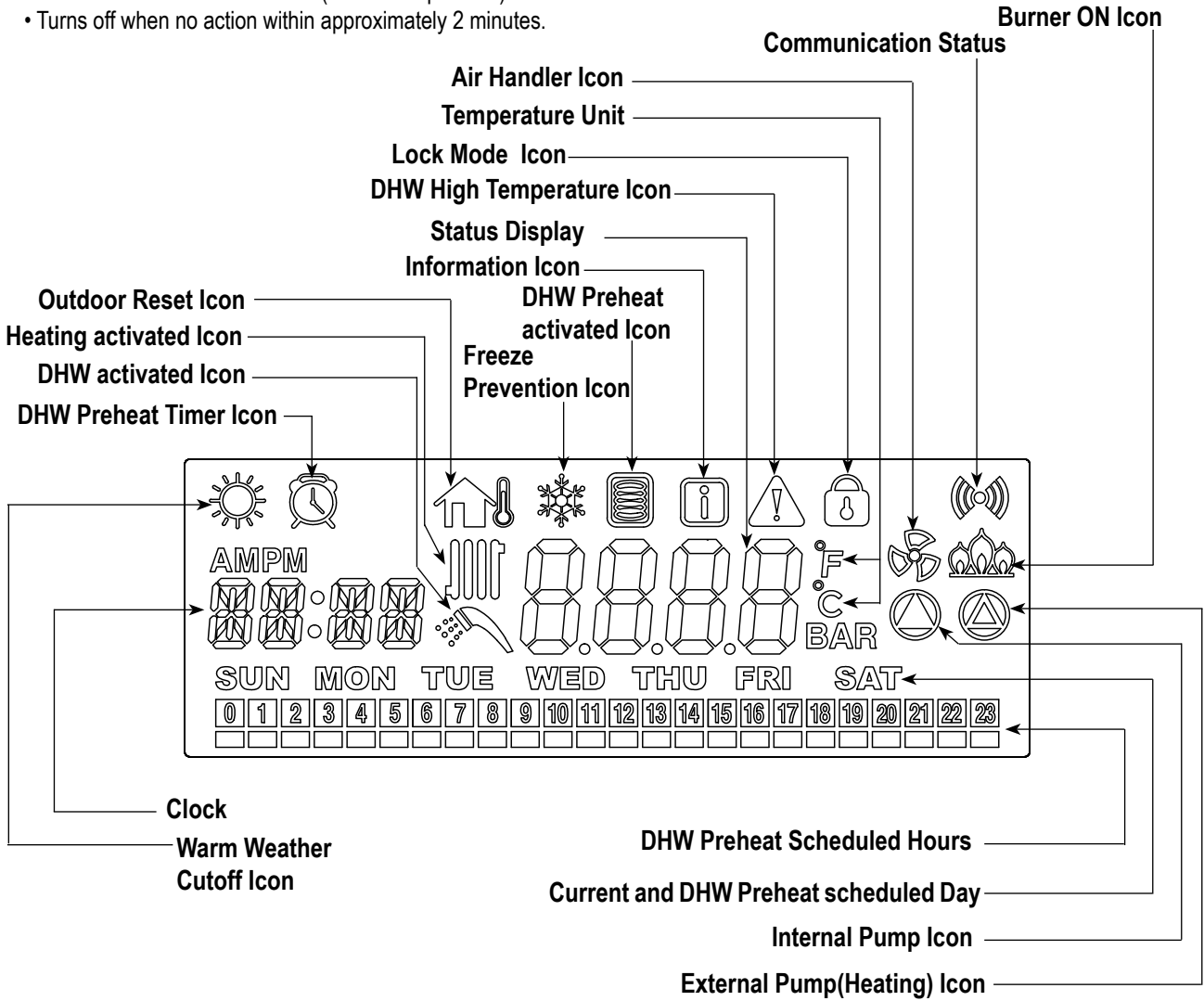

[Example]

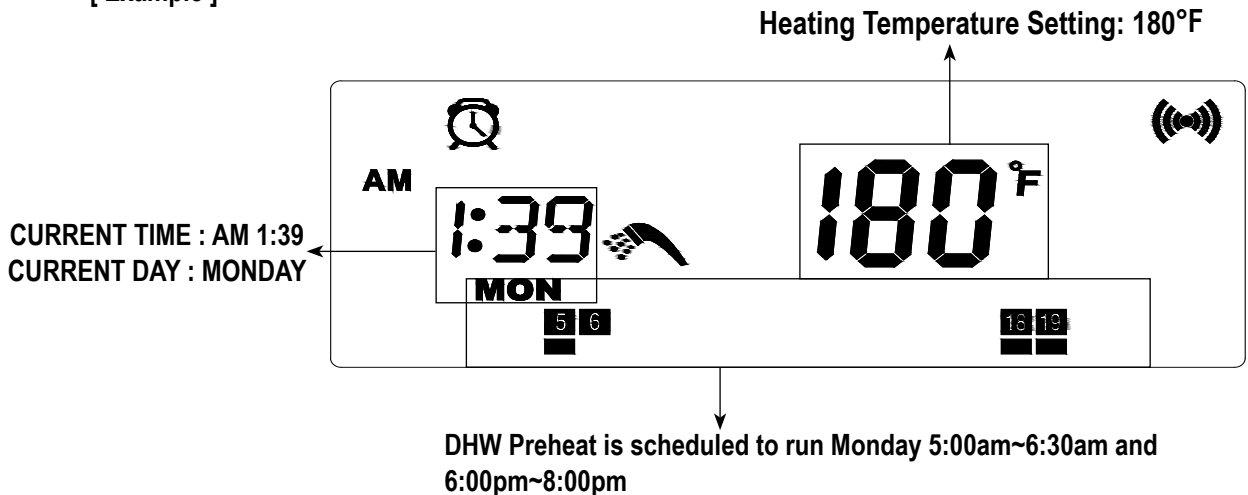

1. Clock Setting

· Time, Day, Month, Year, Days of the Week setting.

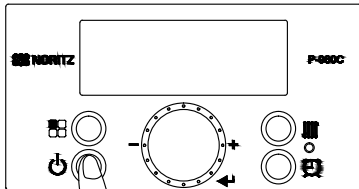

Press the 'Power Button' ON.

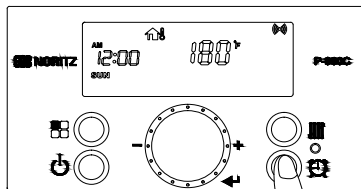

Press and hold 'Timer Button' for 5 seconds.

Blinking(🏠) - is not an Error Code. Refer to page 21.

1. 'Year' Setting
[For Example]
Year: 2016

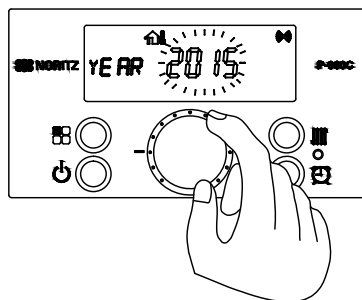

Set the 'Year' by turning the 'Dial Button'. (Only the blinking number can be changed.)

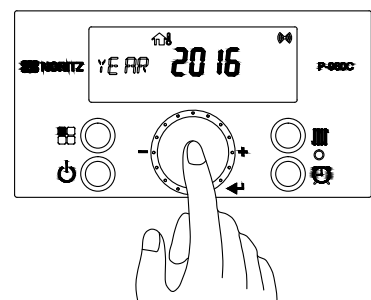

Press the 'Dial Button' to save the setting.

2. 'Month' Setting
[For Example]
Month: 7

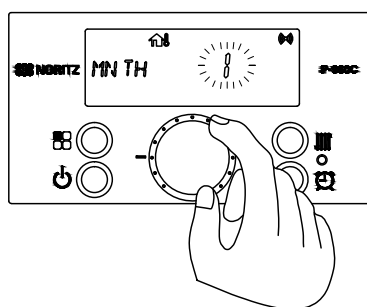

Set the 'month' by turning the 'Dial Button'. (Only the blinking number can be changed.)

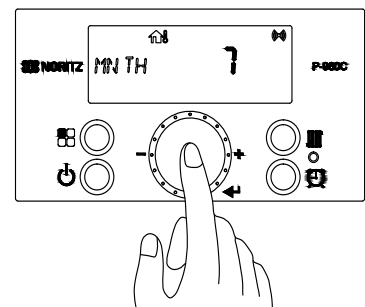

Press the 'Dial Button' to save the setting.

3. 'Day' Setting
[For Example]
Day: 25th

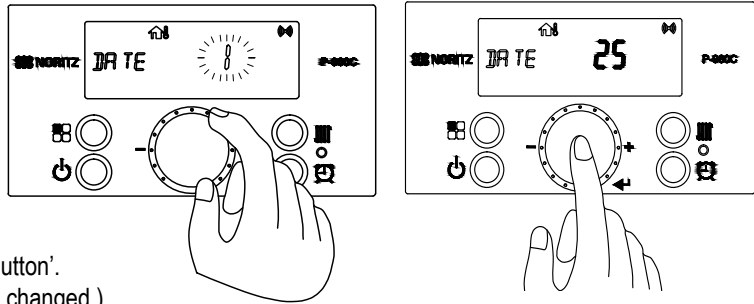

Set the 'day' by turning the 'Dial Button'.
(Only the blinking number can be changed.)

Press the 'Dial Button' to save the setting.

4. 'Hour' Setting
[For Example]
Hour: 10

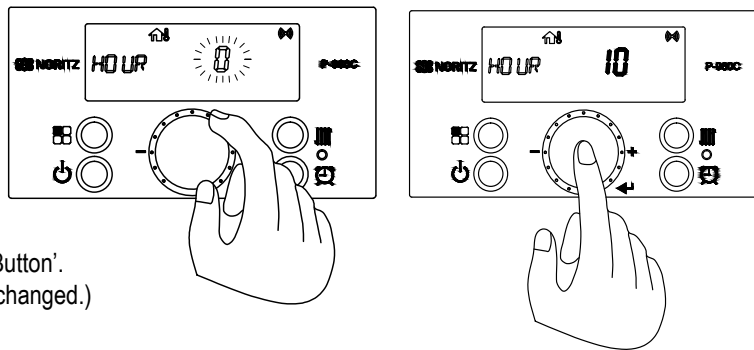

Set the 'hour' by turning the 'Dial Button'.
(Only the blinking number can be changed.)

Press the 'Dial Button' to save the setting.

5. 'Minute' Setting
[For Example]
Minute: 20

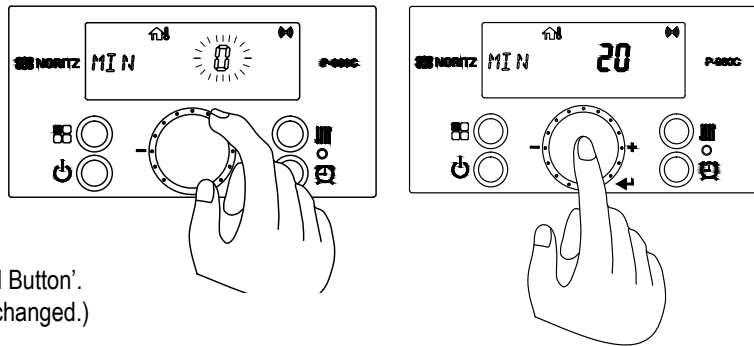

Set the 'minute' by turning the 'Dial Button'.
(Only the blinking number can be changed.)

Press the 'Dial Button' to save the setting.

6. 'Day of the week' Setting
[For Example]
Day: Friday

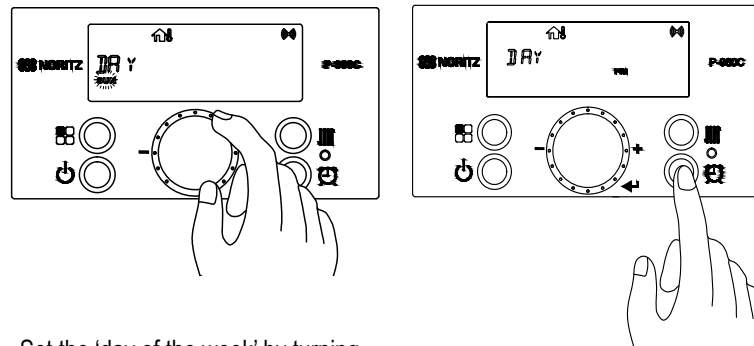

Set the 'day of the week' by turning the 'Dial Button'. (Only the blinking number can be changed.)

Press the 'Timer Button' to save the current setting.



[For example]
2016 / July / 25 / Friday 10
hour / 20 min

2. Setting Domestic Hot Water Temperature (DHW)

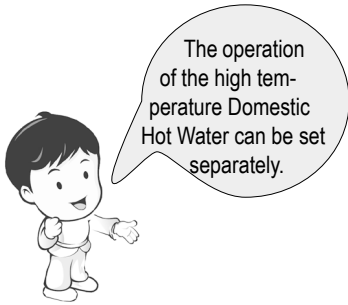

| | General temperature range | | | | High temperature range | | |
|-----------------|---------------------------|-------|-----|------|------------------------|-----|--|
| °F | 90 | | 120 | 121 | | 140 | |
| Factory Default | | | | | | | |
| °C | 32 | | 49 | 49.5 | | 60 | |

The temperature settings below are examples. The temperature setting necessary depends on the usage, the length of piping and the time of year.

General temperature range

High temperature range

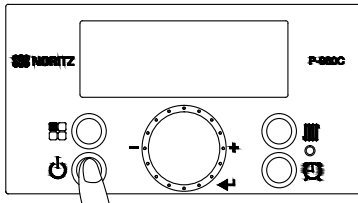

Press the 'Power Button' ON.

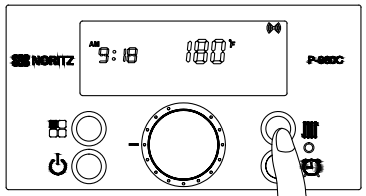

Press and hold the 'Temperature Setting Button' for 5 seconds for Domestic Hot Water temperature setting.

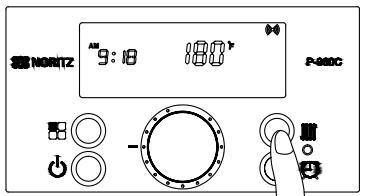

Press and hold the 'Temperature Setting Button' for 5 seconds to get to temperatures setting, then press and hold the 'Temperature Setting Button' again for 5 seconds for high temperature settings.

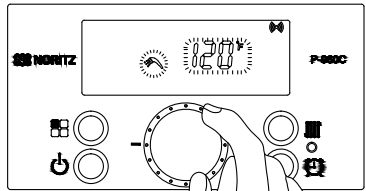

The 'DHW Icon' and 'current DHW setting temperature' will be blinking. DHW temperature setting can be adjusted by turning the 'Dial Button' from 90°F to 120°F (32°C~49°C) in 1°F(0.5°C) intervals.

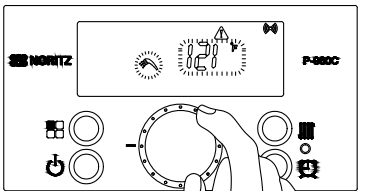

High temperature setting can be adjusted by turning the 'Dial Button' from 121°F to 140°F. (49.5°C~60°C) in 1°F(0.5°C) intervals.

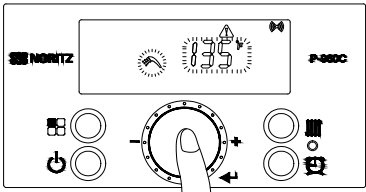
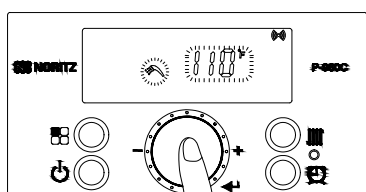

Press the 'Dial Button' to save the DHW Temperature and return to normal mode.

3. DHW Preheat Activated Setting

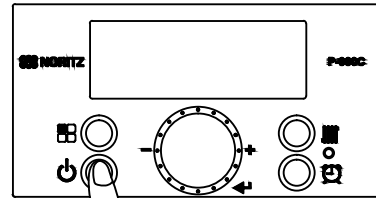
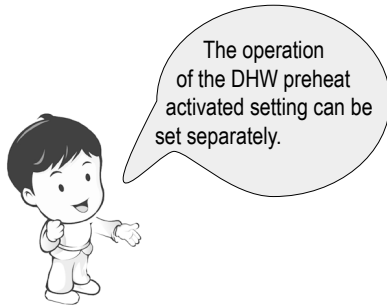

1. Press the 'Power Button' OFF. The control panel must be off.

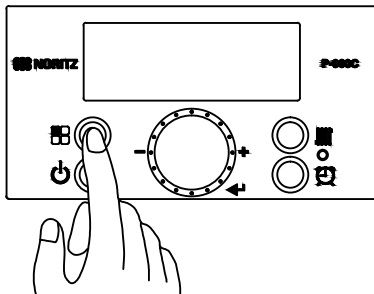

2. Press and hold the 'Function Button' for 5 seconds to enter 'Installer Mode'.

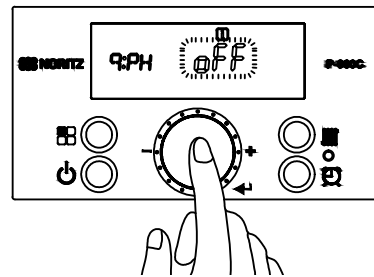

3. Turn the 'Dial Button' clockwise until 9:PH is displayed. Then press the 'Dial Button' so 'oFF' is blinking.

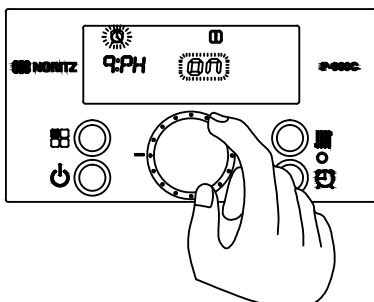

4. Turn the 'Dial Button' clockwise so 'on' and 'DHW Preheat Timer Icon' are blinking. Then press the 'Dial Button' to save the setting.

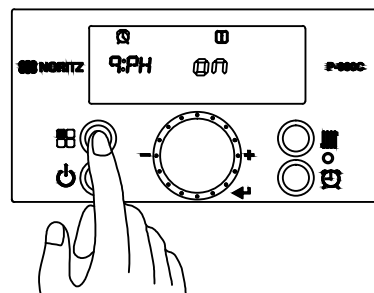

5. Press the 'Function Button' to exit 'Installer Mode'.

4. DHW Preheat Timer Setting

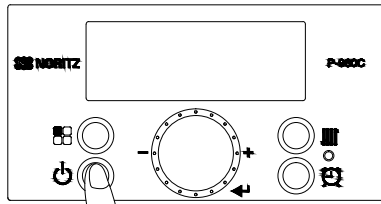

1. Press the 'Power Button' ON.

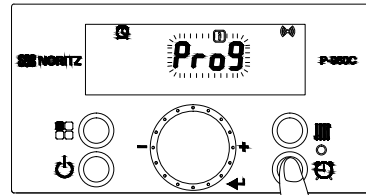

2. Press the 'Timer Button'.

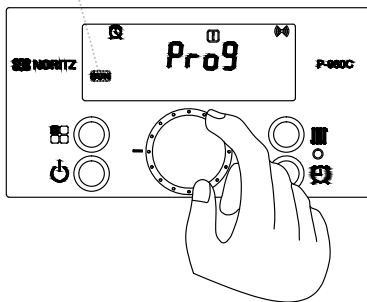
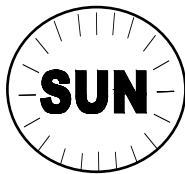

3. Press the 'Timer Button' again so today's day [For Example: Sunday] is blinking. Then turn the 'Dial Button' clockwise or counter-clockwise until 'the desired day' is displayed.

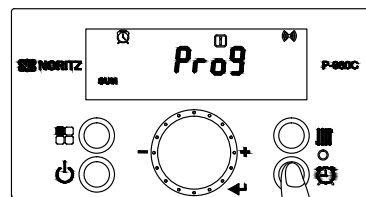

4. Press the 'Timer Button' to save the Day.

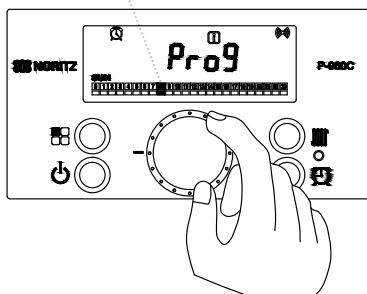
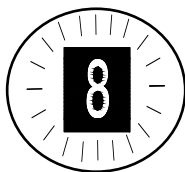

5. Current Time [For Example: 8am] is blinking, then turn the 'Dial Button' clockwise or counter-clockwise until 'the desired hour' is displayed. Press the 'Dial Button' to save the Hour (Icon is lit). Then the next 'Time Icon' will be blinking. Continue pushing the 'Dial Button' to select each 30 minute time block that is consecutive. To skip some time blocks turn the 'Dial Button' to next desired time and press the 'Dial Button' to select the next time blocks. Press the 'Timer Button' to save the setting.

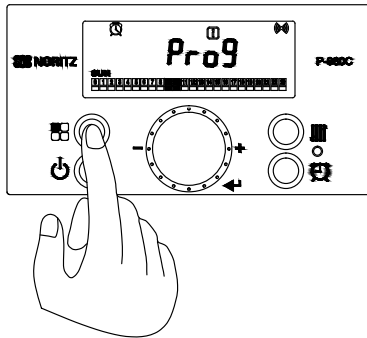

6. Press the 'Function Button' to return to 'Day'. Repeat steps 3-5 for each day of the week.

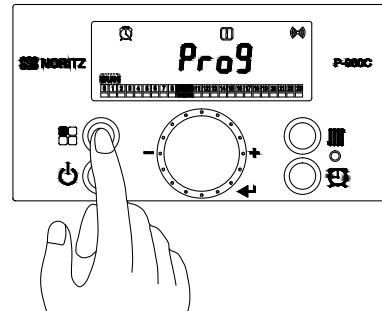

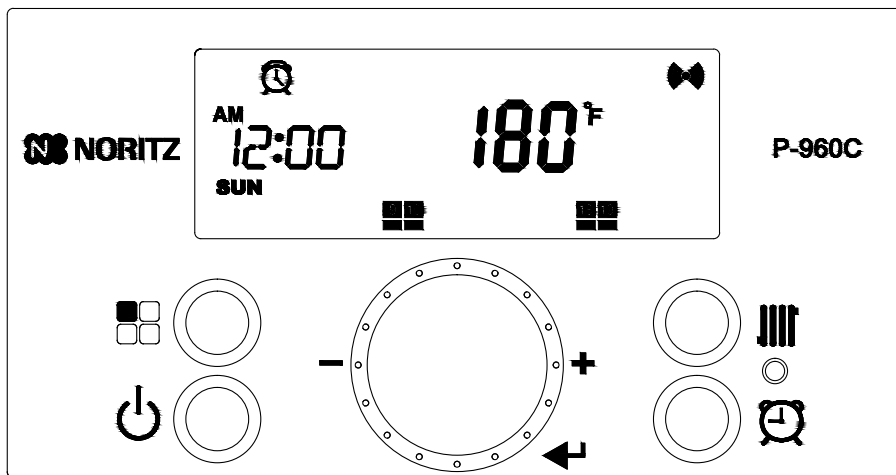

7. After completing all settings, press the 'Function Button' **three times** to return to normal mode.



[For Example] Today is Sunday
 DHW Preheat is scheduled to run Sunday 9:00am~11:00am and 6:00pm~8:00pm.

| | | | | | | | | | | | | | | | | | | | | | | | | |
|---|---|---|---|---|---|---|---|---|---|----|----|----|----|----|----|----|----|----|----|----|----|----|----|--|
| 0 | 1 | 2 | 3 | 4 | 5 | 6 | 7 | 8 | 9 | 10 | 11 | 12 | 13 | 14 | 15 | 16 | 17 | 18 | 19 | 20 | 21 | 22 | 23 | |
| | | | | | | | | | | | | | | | | | | | | | | | | |

5. Setting Heating Temperature

- Blinking () on the control panel is not an Error Code.
- The unit has the 'Outdoor Reset (Energy Saving)' feature, but this feature is disabled(Factory Default).
- To enable, contact your installer or Noritz America Technical Support at 866-766-7489.
- () is lit on the control panel, the Outdoor Reset (Energy Saving) is enabled.
- Heating Temperature is changing automatically based on the Outdoor Temperature.

The following Heating Temperature Setting can be changed when the 'Outdoor Reset' is disabled.

| General temperature range | | | |
|---------------------------|-----|-------|-----------------|
| °F | 100 | | 180 |
| | | | Factory Default |
| °C | 38 | | 82 |

The temperature settings below are examples. The temperature setting necessary depends on the usage, the length of piping and the time of year.

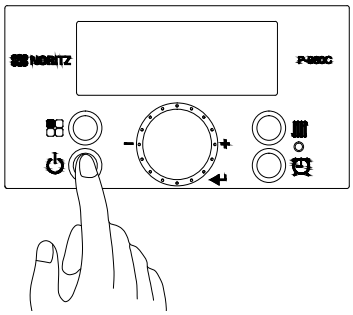

1. Press the 'Power Button' ON.

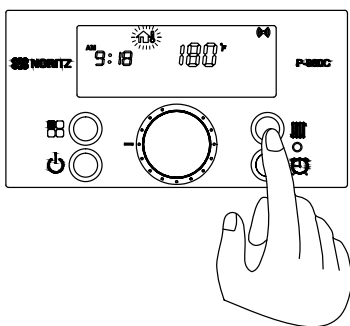

2. Press the 'Temperature Setting Button'.

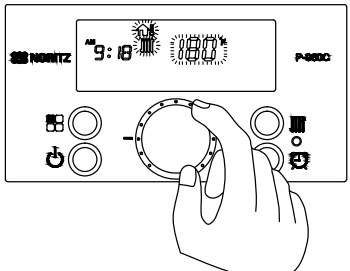

3. The 'Heating Icon' and 'current Heating temperature setting' will be blinking. Heating temperature can be adjusted by turning the 'Dial Button' from 100°F to 180°F (38°C~82°C) in 1°F(0.5 °C)intervals.

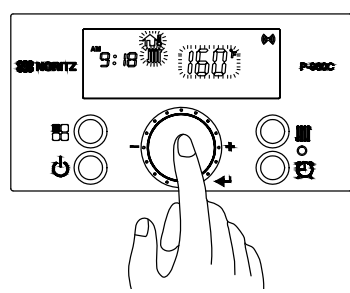

4. Press the 'Dial Button' to set the Heating Temperature and return to normal mode.

‘User Mode’

Function can be checked and set in ‘User Mode’.
 ([A: GA] - [C: TL] - [g:EH] - [H:RH])

| Screen Display | Operation | Description |
|----------------|----------------------|--|
| A: GA/L | Gallon or Liter Unit | GAL / Lit (Refer to page 25) |
| C: TL | Lock Mode | Lock mode is used(on) or unused(oFF) |
| g: EH | Error History | View the Error History (E0:XX ~ E9:XX) |
| H: RH | Running History | PLUg: Plug in time bnH.H: Burn hours (Heating) bnH.d: Burn hours (DHW) bnC.H: Ignition times (Heating) bnC.d: Ignition times (DHW) PPHr: Pump hours |

[To enter ‘User Mode’]

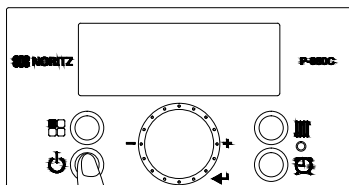

1. Press the ‘Power Button’ ON.

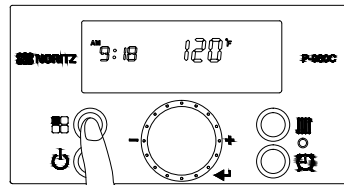

2. Press and hold the ‘Function Button’ for 5 seconds to enter ‘User Mode’.

[For Example] 2.0 GPM

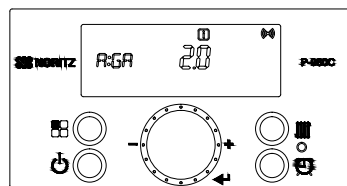

3. ‘[A:GA]’ is displayed on the display screen. Turn the ‘Dial Button’ clockwise or counter-clockwise to navigate through the ‘User Mode’.

4. Press the ‘Function Button’ to return to normal mode.

6. Lock Mode [C:TL]

By locking the control panel, the settings cannot be accidentally changed if a button is pressed by mistake.

- Refer to page 22 for directions on how to enter 'User Mode'.

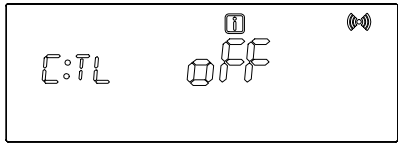

1. In the 'User Mode', turn the 'Dial Button' until [C:TL] is displayed.

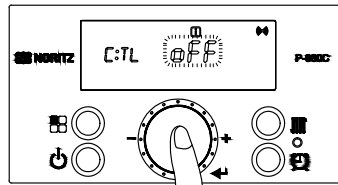

2. Press the 'Dial Button' so 'OFF' is blinking.

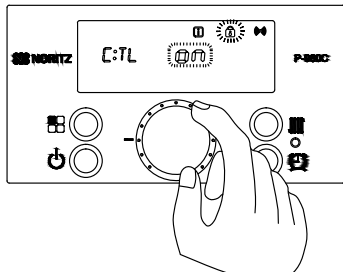
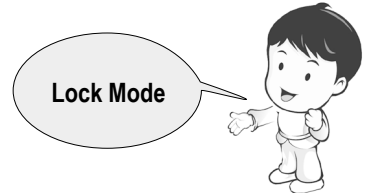

3. Turn the 'Dial Button' clockwise so 'on' and 'Lock Mode Icon' are blinking.

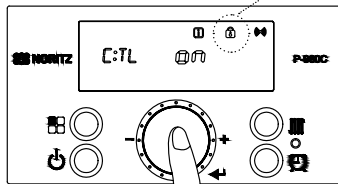

4. Press the 'Dial Button' to save the setting. The Lock Icon will display on the control panel.

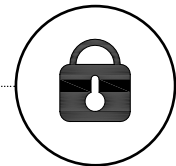

7. 'Error History'. [g:EH]

- Refer to page 22 for directions on how to enter 'User Mode'.

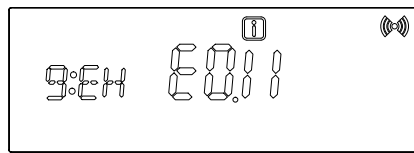

1. In the 'User Mode', turn the 'Dial Button' until [g:EH] is displayed.

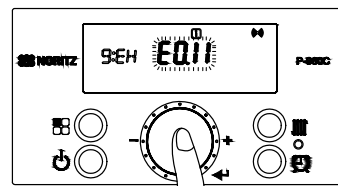

2. ERROR CODE that have occurred can be identified and 'E0.11' is blinking when the 'Dial Button' is pressed in '[g:EH]'.

[For example]
1 st error occurs : 11
2 nd error occurs: 16

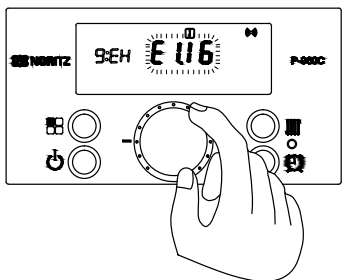

3. ERROR CODE that have occurred from E0 to E9 can be identified by turning the 'Dial Button' clockwise.

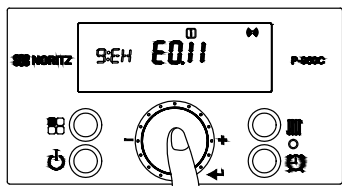

4. Press the 'Dial Button' to return to 'User Mode'.

8. 'Running History' [H:RH]

- Refer to page 22 for directions on how to enter 'User Mode'.

| Screen Display | Description | Example |
|----------------|---------------------------------------|--|
| PLUg | Power-on Time | EX) 21.3 → 21.3 X 1,000 = 21,300 hour |
| bnH.H | Burner Running Hour with Heating Mode | EX) 3.2 → 3.2 X 1,000 = 3,200 hour |
| bnH.d | Burner Running Hour with DHW Mode | EX) 1.3 → 1.3 X 1,000 = 1,300 hour |
| bnC.H | Ignition Times with Heating Mode | EX) 86 → 86 X 1,000 = 86,000 times |
| bnC.d | Ignition Times with DHW Mode | EX) 57 → 57 X 1,000 = 57,000 times |
| PPHr | Pump Operation Hour | EX) 125.2 → 125.2 X 1,000 = 125,200 hour |

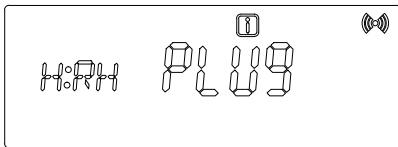

1. In the 'User Mode', turn the 'Dial Button' until [H:RH] is displayed.

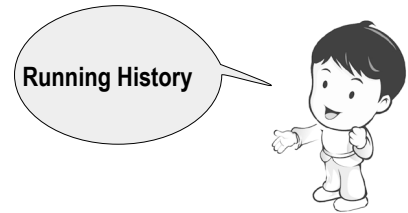
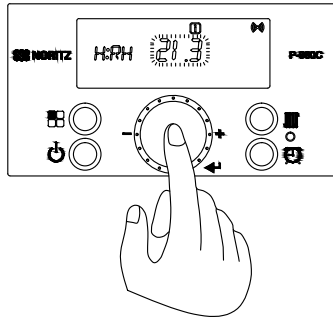

2. Press the 'Dial Button' so 'PLUg' is blinking. Then press the 'Dial Button' again to display the value. Press the 'Function Button' to return to 'PLUg' blinking.

[PLUg] : Means hour of the power supply.
EX) 21.3 → 21.3 X 1,000 = 21,300 hour

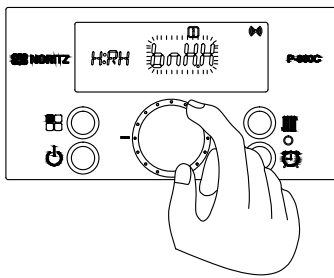

3. Turn the 'Dial Button' clockwise to display 'bnH.H', it will be blinking.

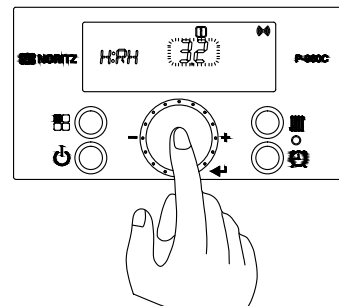

4. Press the 'Dial Button' to display the value. Then press the 'Function Button' to return to 'bnH.H' blinking.

5. Repeat steps 2-4 with other items in the running history.

[bnH.H] : Means Burner Running Hour with Heating mode
EX) 3.2 → 3.2 X 1,000 = 3,200 hour

9. 'Unit' Setting [A:GA]

- Refer to page 22 for directions on how to enter 'User Mode'.

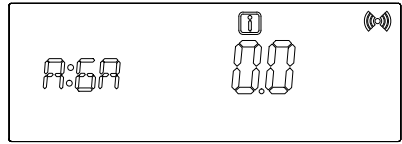
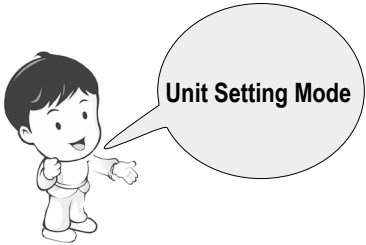

1. After entering 'User Mode' the first item displayed will be [A:GA].

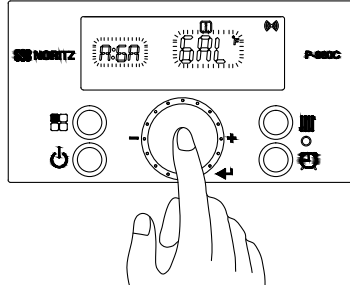

2. Press the 'Dial Button' so 'A:GA', 'GAL' and '°F' are blinking.

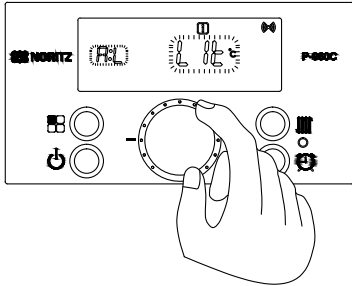

3. Turn the 'Dial Button' counter-clockwise so 'A:L', 'Lit' and '°C' are blinking.
 * GAL = GPM / °F
 * Lit = LPM / °C

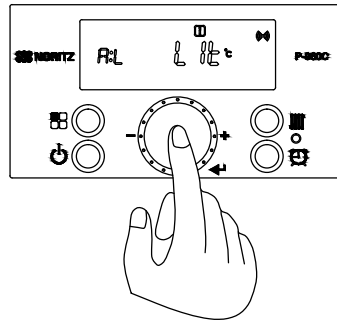

4. Push the 'Dial Button' to save the setting and return to 'User Mode'.

| Screen Display | Operation | Description |
|-----------------|----------------------------|---|
| GAL °F | Unit : Gallon & Fahrenheit | All of the units shown on the display screen are GPM & °F |
| L Lit °C | Unit : Liter & Celsius | All of the units shown on the display screen are LPM & °C |

10. Preventing Damage from Freezing-1

CAUTION

- **Damage can occur from freezing water within the device and pipes even in warm environments. Be sure to read below for appropriate measures.**
- **Repairs for damage caused by freezing are not covered by the warranty.**

1. Freeze Prevention

- This Combi Boiler has functions to protect itself from freezing by operating the pump and turning on the burner when the thermistor detects lower than 54°F(12°C).
- During Freeze Prevention, () is lit on the control panel.

2. Heating System

- Freeze protection products may be used for the heating system. Freeze protection for new or existing systems requires specially formulated glycol, which contains inhibitors to prevent the glycol from attacking the metallic system components.
- Before using freeze protection products, ensure that system fluid contains proper glycol concentration and the inhibitor level is appropriate. Noritz recommends against exceeding a 50% concentration of glycol.
- When using the freeze protection products, the system must be tested at least once a year, and as recommended by the manufacturer of the glycol solution.
- When using the freeze protection products, allowance should be made for expansion of the glycol solution.
- Freeze damage is not covered by the warranty.



Electrical power, gas, water and the main switch must be on. If any of the above items are not connected properly, then water must be drained including the condensation trap and unit unplugged from electrical power.

If the Combi Boiler will not be used for a long period of time, drain the water.

CAUTION

- To avoid burns, wait until the equipment cools down before draining the Domestic Hot Water.
- The appliance will remain hot for short period after it is turned off.

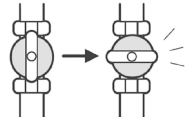
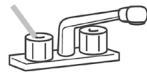
Drain the water into a bucket to prevent water damage.

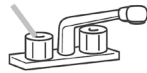
| | |
|--|---|
| <p>1. Close the gas valve.</p> |  |
| <p>2. (1) Turn the 'Power Button' ON. (2) Turn and leave open the Hot Water fixtures/ faucets for more than 2 minute and close. * An 11 Error Code may appear on the control panel. This is not a malfunction of the unit. Do not turn the 'Power Button' OFF.</p> | <p>Hot water fixture/faucet</p>  |
| <p>3. Close the both DHW inlet and Auto Feeder Inlet water supply valve and disconnect the electrical power supplied to the unit.</p> <p style="text-align: center;">Do not touch with wet hands.</p> |  |
| <p>4. Fully open all Hot Water fixtures/faucets.</p> | <p>Hot water fixture/faucet</p>  |

5. Open all drain plugs and drain the water out of the unit.
 6. When the water is completely drained, replace all drain plugs and close the Hot Water fixtures/faucets.

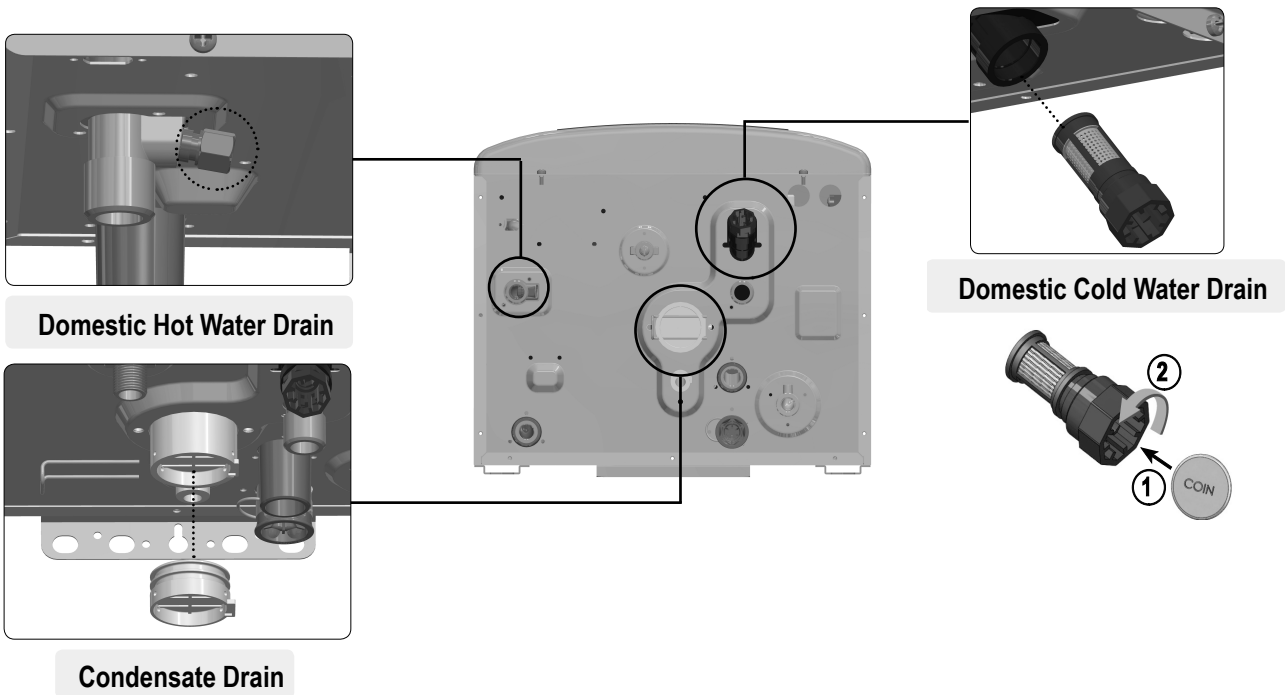



If the Combi Boiler will not be used for a long period of time, drain the water.

⚠ CAUTION

- To avoid burns, wait until the equipment cools down before draining Heating Water.
- The appliance will remain heat for short period after it is turned off.

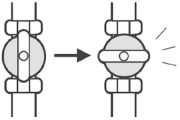
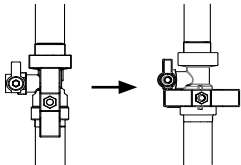
Drain the water into a bucket to prevent water damage.

| | |
|--|---|
| <p>1. Close the gas valve.</p> |  |
| <p>2. (1) Close the isolation valves for supply and return heating pipes (2) Turn the 'Power Button' OFF.</p> |  |
| <p>3. Close the both DHW inlet and Auto Feeder Inlet water supply valve and disconnect the electrical power supplied to the unit. 4. Connect the hose to the drain valve in supply or return heating pipe of isolation valve assembly.</p> <p style="text-align: center;">Do not touch with wet hands.</p> |  |
| <p>5. Full open the drain valve where connected the hose 6. Open the heating return filter after release fix clip. 7. When heating water is drained completely, replace the heating return filter and fix clip.</p> | |

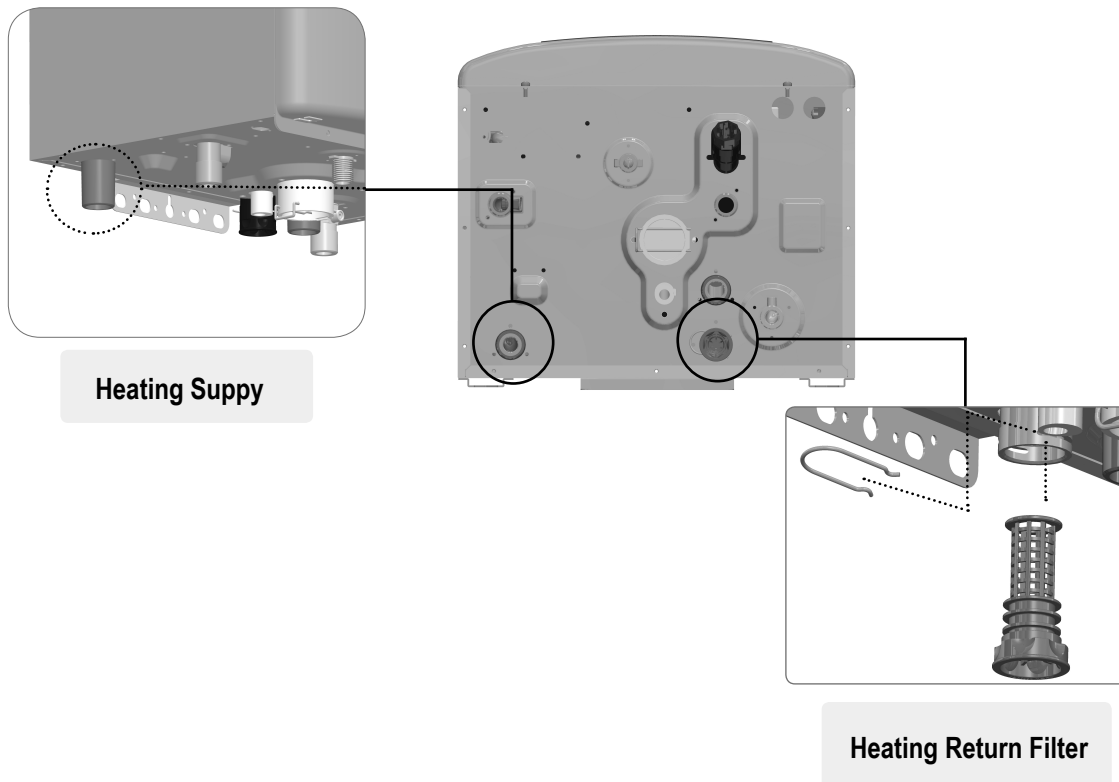

11. Preventing Damage from Freezing-2

1. Turning the Unit Back On

1. Check that all drain plugs are inserted.
 2. Check that all Hot Water fixtures/faucets are closed.
 3. Follow the procedure on page 12 'Initial operation', steps 1 through 4.
 4. Make sure that the area around the appliance is well ventilated; open a window or a door if necessary.
Then, operate the unit and verify that condensate is coming out of the drain pipe.
(During normal use of the Combi Boiler, condensate will begin to discharge from the drain pipe within 15 minutes of use. However, depending on the season and/or installation site conditions, it may take longer.)
- If water does not appear at the end of the drain line, a qualified service technician must clean the condensate line.

DANGER

After the Combi Boiler has been out of use for a long time make sure that fill the condensate trap with water. This is to prevent dangerous exhaust gases from entering the building. Failure to fill the condensate trap could result in severe personal injury or death. (By performing step 4 as described above, the condensate trap will automatically fill itself with water.)

1. General Maintenance

■ Regular Maintenance

- After Combi Boiler installation is completed, the Installation Manual should be placed in near the Combi Boiler. Maintenance instructions should be carried out by the guidelines. Maintenance detail lists, please refer to the instructions below.

| | |
|------------------------------|--|
| Monthly | Check vent pipe. Check air inlet pipe. Check pressure relief valve. Check condensate drain outlet. |
| Annually | Check Combi Boiler piping (Gas and Water leakage). Check the operation of both Domestic and Heating pressure relief valves. |
| No plan of use for long-term | Do not disconnect electrical power. |

■ Maintenance procedures

- Check installation location
To prevent potential severe personal injury, death or substantial property damage, remove all contaminated materials. If contaminants are found :
Remove products immediately from the area.
In order to check the status of Combi Boiler, call a qualified service technician to inspect the Combi Boiler for possible damage from acid corrosion.
DO NOT store combustible materials, gasoline or any other flammable vapors or liquids near the Combi Boiler. Remove them immediately or store them other places.
- Check if Combi Boiler front cover is closed.
Check if there is any problem with the Combi Boiler front cover and the two upper and lower screws are tightened well. Combi Boiler front cover must be closed while it is operating.
- Check power source.
Make sure that the power cord is property connected. The main power line is connected to the manual switch box inside a Combi Boiler.
- Check status of the control panel.

■ Maintenance procedures [Monthly]

- Check vent pipe.
Visually inspect the flue gas vent piping for detecting any signs of blockage, leakage or deterioration of the piping. Please contact a qualified service technician immediately if you find any problem.
- Check air inlet pipe.
Visually inspect the air inlet whether it is unobstructed. Inspect entire length of air piping for ensuring that piping is intact and all joints are properly sealed.
Call a qualified service technician if any problem is observed.
- Check the condensate outlet.
While the Combi Boiler is running, check the discharge end of the condensate drain tubing.
Make sure that no flue gas is escaping from the condensate drain tubing.
If flue gas is continuously escaping, it is a serious problem. Call a qualified service technician to inspect the Combi Boiler and condensate line. Also, refill the condensate trap if problem persists regularly.

- Check bird screen.

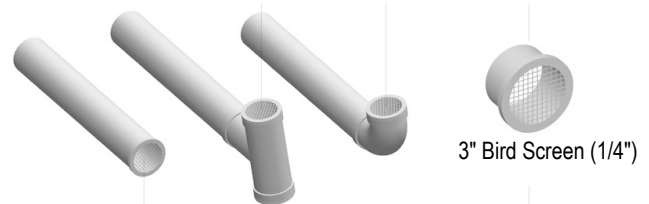



If you encounter a problem of combustion specifications, visually inspect the bird screen(s). And then replace it with spare parts or clean the screens.

2. Cleaning the Combi Boiler

1. Cleaning Air Intake Filter

To properly maintain the Combi Boiler, check air intake filter every month. If not, a problem with combustion specifications will occur.

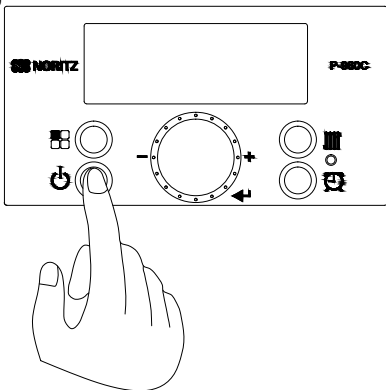
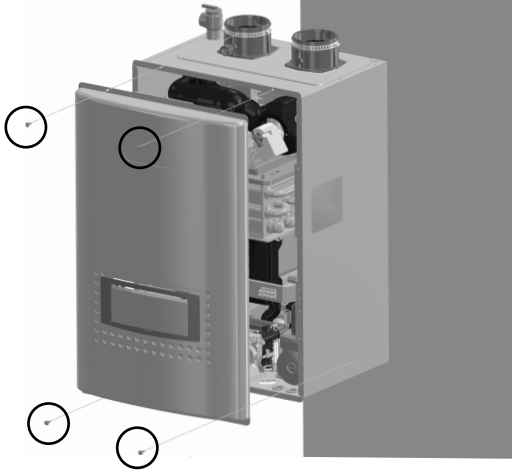
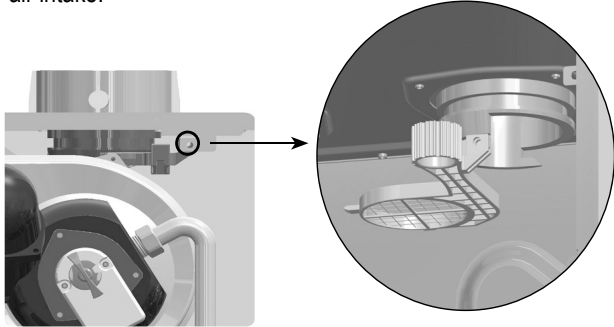
To clean air intake filter:

| | |
|--|--|
| <p>1. Press the 'Power Button' on the control panel to turn off the Combi Boiler. 2. Disconnect the power supply from the Combi Boiler. 3. If Combi Boiler has been operating, wait for it to cool before continuing</p>  | <p>4. Remove the 4 screws on the front cover of the Combi Boiler.</p>  |
| <p>5. Remove the filter screen screw and pull the filter out of the air intake.</p>  | <p>6. Clean it with a toothbrush and clean running water.</p>  |
| <p>7. Dry the filter completely. Then reinsert the filter into the plastic assembly and tighten the filter screen screw. 8. Replace the front cover of the Combi Boiler cabinet. Reconnect power supply to the Combi Boiler. 9. Press the 'Power Button' on the control panel to turn on the Combi Boiler.</p> | |

2. When supplying combustion air from the indoors.

To clean air supply vent:

Check for debris or blockage from dust, oil, etc. at the air supply vent. If blocked, remove the build-up with a vacuum cleaner or damp towel. (Do not permanently remove the inlet screen.)

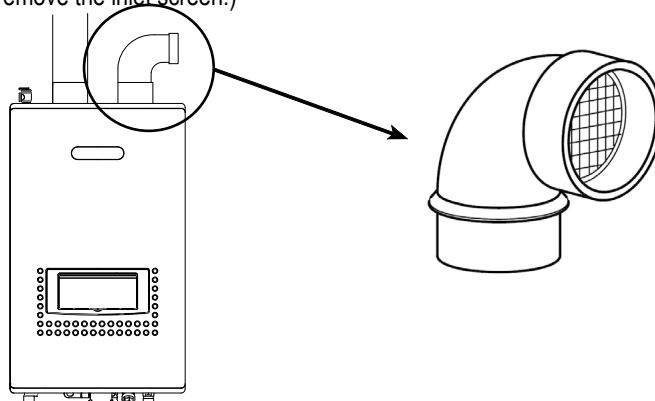

- Cleaning Cold water inlet filter / Heating filter

1. Place a bucket under the appliance to collect the residual water inside the Combi Boiler.
2. Press the 'Power Button' OFF on the control panel and disconnect the electrical power to the Combi Boiler.
And then turn off the gas valve.
3. Close the both DHW inlet and Auto Feeder Inlet water valves and Heating valves.
4. Open the Hot water faucets completely.

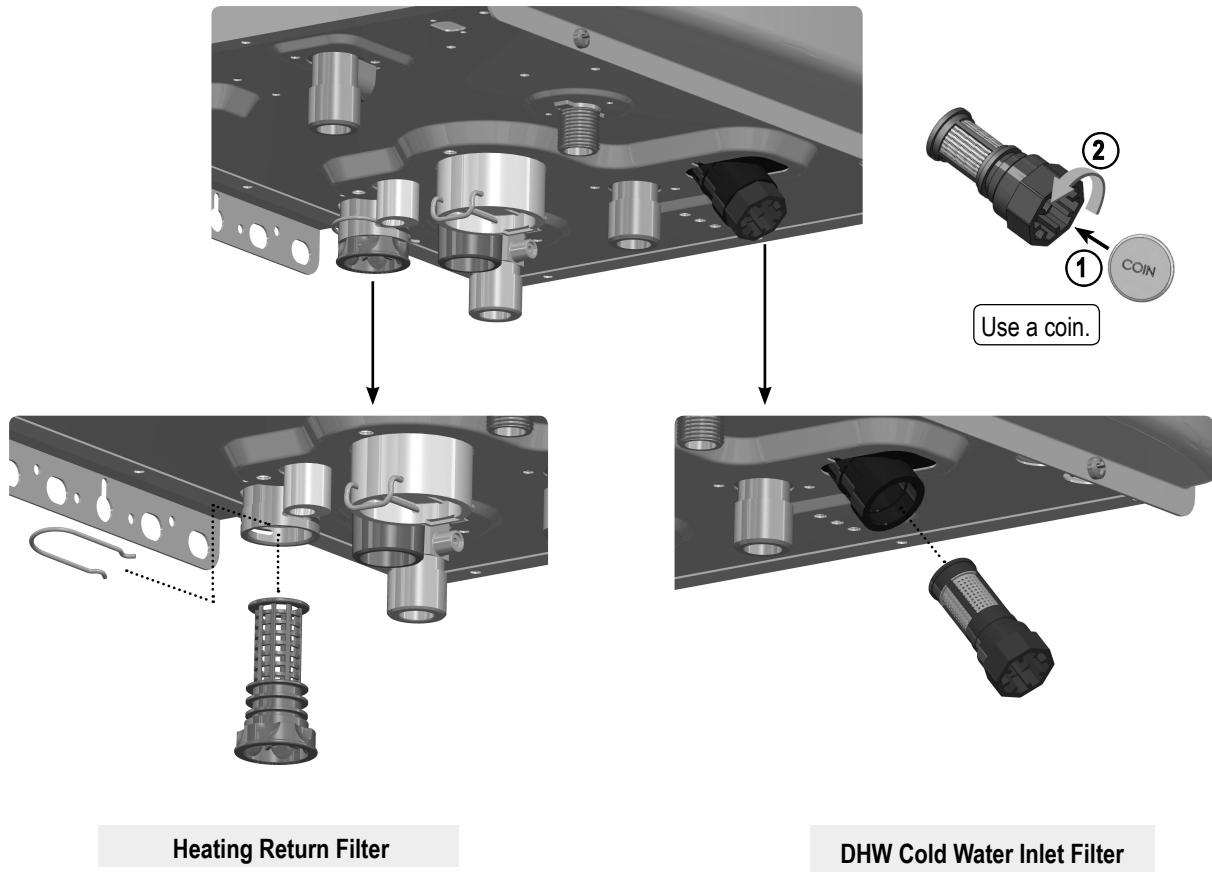

5. Remove the DHW Cold Water inlet filter and Heating Return filter. And then clean it with a toothbrush and clean running water.



6. To refill the Combi Boiler, follow the steps of 'Draining the Combi Boiler' in reverse.
7. Plug back power cord of the unit to start operation.

3. Flushing the Combi Boiler

- Flushing the Combi Boiler

Flushing the Heat Exchanger of Combi Boiler is a complicated procedure. Refer to the following instructions carefully before attempting the procedure. If you do not understand the procedure, contact an authorized technician or licensed professional. Keep in mind that improper maintenance will void the warranty.

1. Disconnect electric power to the Combi Boiler.
2. Close the shutoff valves on both Domestic Hot Water supply and DHW Cold Water inlet lines. (V1 & V2)
3. Connect one hose 'D1' to the valve 'V3' and place the free end in the bucket. Connect one of the hoses 'D3' to the circulation pump outlet and the DHW Cold Water inlet line at the valve 'V4'. Connect other hose 'D2' to the circulation pump inlet and place the free end in the bucket.
4. Pour the cleaning solution into the bucket. White Vinegar is suggested. Place the drain hose (D1) and the hose (D2) into the cleaning solution.
5. Open service valves (V3 & V4) on the Domestic Hot Water supply and DHW Cold Water inlet lines.

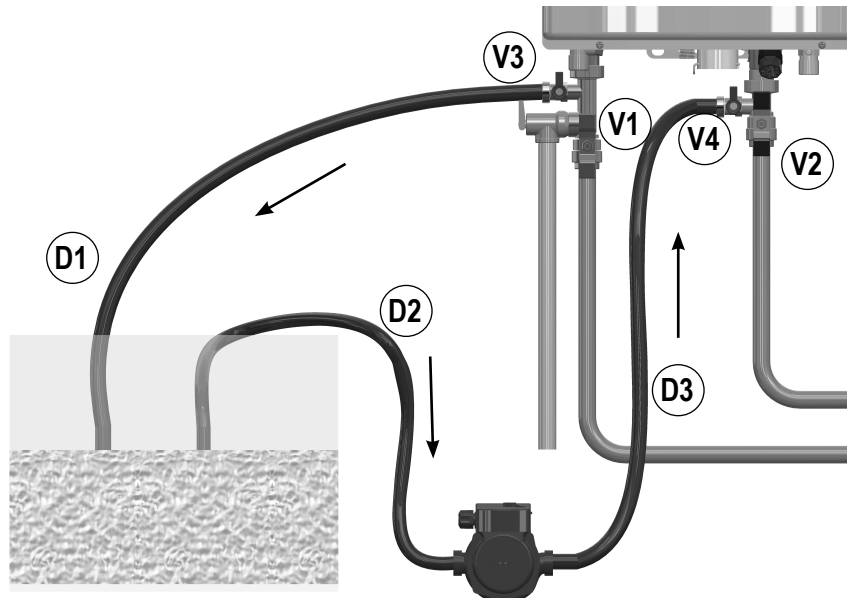

6. Turn on the pump to circulate the cleaning solution through the Combi Boiler for at least 1 hour at a rate of 4 gallons per minute.
7. Rinse the cleaning solution from the Combi Boiler as follows:
 - Remove the free end of the drain hose (D1) from the bucket.
 - Close service valve, (V4), and open shutoff valve, (V2). Do not open shutoff valve, (V1).
 - Allow water to flow through the Combi Boiler for 5 minutes.
 - Close shutoff valve (V2).
8. Disconnect all hoses.
9. Remove the DHW Cold Water inlet filter from the Combi Boiler and clean out any residues.
10. Reinsert the filter and ensure the filter cap is securely tightened.
11. Connect electrical power to the Combi Boiler.

⚠ WARNING

Leaks must be fixed by a qualified service technician immediately. Failure to comply with this instruction could result in severe personal injury, death or substantial property damage. This discharge line must be installed by a qualified heating installer or a service technician.

■ Maintenance procedures [Annually]

- Check piping. (gas and water)

Visually inspect for leaks around internal water piping. Also inspect external water piping, circulators, pressure relief valves and fittings. Immediately call a qualified service technician to repair any leaks.

Leaks must be fixed by a qualified service technician immediately. Failure to comply with this instruction could result in severe personal injury, death or substantial property damage.

- Check for operation of the pressure relief valves

Before proceeding, verify that pressure relief valve outlets has been piped to a safe place of discharge, avoiding any possibility of scalding from Domestic Hot Water. If water flows freely, release the lever and allow the valve to seat. Watch the end of the pressure relief valve discharge pipe to ensure that the valve does not weep after the line has had time to drain. If the valve weeps, lift the seat again to attempt to clean the valve. If the valve continues to weep, contact your qualified service technician for inspecting the valve and system. If water does not flow from the valve even though you have lifted the lever completely, the valve or discharge line may be blocked. Shut down the Combi Boiler immediately. Call your qualified service technician to inspect the Combi Boiler and system. Both DHW and Heating pressure relief valves should be checked.

- Check burner state

You can clean the exterior of burner. However, if you need to clean the inside of the burner, you should call an qualified service technician.

4. Checking for Error Conditions

When the Combi Boiler encounters an error, the display will flash ‘Er’ followed by a numerical code. The Combi Boiler shall enter a soft lockout condition if the error is such that it can return to normal operation once the condition relieves itself (overheat conditions, temperature sensor open or shorts, etc.). The Combi Boiler shall enter a hard lockout if the condition indicates the unit detected a condition preventing safe operation (Er.11_Ignition, Er.29_Condensate line, Er.40_Gas leakage) To clear a hard lockout Error Code, press the ‘Power Button’ off then on.

The following screen will display when the Combi boiler encounters an error.

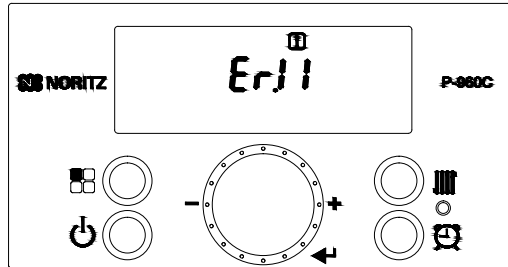



| Error Code | Error Code Description | Possible Remedies |
|------------|---|--|
| Er:11 | Ignition has Failed 10 (Ten) Times | <p>Press the ‘Power Button’ to clear the Error Code. If error code still appears on the display then check the following.</p> <ul style="list-style-type: none"> • Make sure that the gas valve is in the fully open position. <p>If Error happens again: Contact the installer or Noritz America Technical Support for assistance.</p> |
| Er:29 | Air Pressure Sensor Abnormality | <p>Press the ‘Power Button’ to clear the Error Code. If error code still appears on the display then check the following.</p> <ul style="list-style-type: none"> • Make sure that the exhaust pipe is free of obstructions. • Clean the intake air filter. • Make sure that clogged of condensate trap or drain pipe. <p>If Error happens again: Contact the installer or Noritz America Technical Support for assistance.</p> |
| Er:40 | Gas Leakage is Detected in 10 Minutes, or three times within One Hour. (Greater than 5 Seconds Each Time) | <p>IMPORTANT: If you smell gas, STOP! Follow the instructions on page 4, this guide, and call a qualified service technician or the gas utility. Press the ‘Power Button’ to clear the Error Code.</p> <p>If Error happens again:</p> <ul style="list-style-type: none"> • Check the Combi Boiler cover. Ensure it is secure. • Check gas connections for leakage with a soapy solution. Fix any leaks. • Check condition of the burner assembly. • If the problem persists, replace the circuit board. |
| Er:45 | Water leakage is detected in Combi Boiler. | <p>Press the ‘Power Button’ to clear the Error Code. If error code still appears on the display then check the following.</p> <ul style="list-style-type: none"> • Check for the water in the bottom of the Combi Boiler inside the case. <p>If you have confirmed the water leak, close the inlet water valves and contact the installer or Noritz America Technical Support for assistance.</p> |
| Er:54 | Low Water Pressure (Heating) | <p>Press the ‘Power Button’ to clear the Error Code. If error code still appears on the display then check the following.</p> <ul style="list-style-type: none"> • Check Domestic Hot Water Supply Valve. (The valve must be open.) <p>If Error happens again: Contact the installer or Noritz America Technical Support for assistance.</p> |

Contact Noritz America at 866-766-7489

- Any other error code appears.
- An error code is indicated again after the above actions were followed.
- There are any other questions.

Troubleshooting

| Problem | Possible Remedies |
|--|--|
| Burner Does Not Ignite | <ul style="list-style-type: none"> • Make sure that the 'Power Button' on the Control Panel is ON. • If the display on the Control Panel is blank, make sure the power cord is plugged in and 3A fuses on the circuit board in the Combi Boiler are good. Power switch inside Combi Boiler is on. • Make sure that the Combi Boiler is supplied with water. The unit activates when inlet water flow sensor detects flow over 0.5 gpm • Make sure the DHW cold and Domestic Outlet pipes are not plumbed in reverse. • Ensure the DHW Cold Water and gas supply valves are open. • Make sure the water lines are not frozen. |
| Domestic Hot Water is Not Hot Enough | <ul style="list-style-type: none"> • Ensure the DHW temperature setting on the Combi Boiler is not too low. • Ensure the filter in the DHW Cold inlet is not clogged with debris. • Make sure the Combi Boiler is connected to the correct gas supply. |
| Water is Too Hot | <ul style="list-style-type: none"> • Ensure the temperature setting is not too hot. • Ensure the filter in the DHW Cold inlet is not clogged with debris. • Make sure the Combi Boiler is connected to the correct gas supply. |
| Domestic Hot Water Temperature Fluctuates at Tap | <ul style="list-style-type: none"> • Ensure the filter in the DHW Cold inlet is not clogged with debris. • Make sure the Combi Boiler is connected to the correct gas supply. |
| The Blower Continues to Operate After Combustion Stops | <ul style="list-style-type: none"> • This is normal. The blower operates for three minutes after combustion has stopped to purge remaining exhaust gas from the flue. |
| Cannot Change the Domestic Hot Water Mode Setpoint above 120°F | <ul style="list-style-type: none"> • This is a safety device to prevent scalding. • Domestic Hot Water temperature over 125°F can cause instant severe burns or death. |
| The Combi Boiler Makes Abnormal Sounds During Operation | <ul style="list-style-type: none"> • Ensure the venting installation complies with the Installation Manual. • Ensure supply gas pressure is sufficient. Insufficient gas pressure will cause unstable burner flame and noise. |
|  Is lit.  Is lit even when the DHW/ Heating are not being used. | <ul style="list-style-type: none"> • The unit automatically operates to prevent freezing. |
| The room does not get warm. The heating does not operate. | <ul style="list-style-type: none"> • Increase Heating Temperature Setting. •  is lit on the control panel, contact your installer. |
| No heating when the burner is on. | <ul style="list-style-type: none"> • Ensure the heating return filter is not clogged with debris. • Ensure the circulation pump is working properly and replace, if defective. |

Water Quality

Damage to the Combi Boiler as a result of poor water quality is not covered by the Limited Warranty. To ensure full warranty coverage, treat or condition water that exceeds the target levels provided in this table.

(Source: EPA National Secondary Drinking Water)

| | |
|------------------------|---------------------------|
| Total Hardness* | 200 mg/L (12 gpg) or less |
| Aluminum | 0.05 to 0.2 mg/L or less |
| Chloride | 250 mg/L or less |
| Copper | 1 mg/L or less |
| Iron | 0.3 mg/L or less |
| Manganese | 0.05 mg/L or less |
| pH | 6.5 - 8.5 |
| Total Dissolved Solids | 500 mg/L or less |
| Zinc | 5 mg/L or less |
| Sulfate ion | 250 mg/L or less |
| Residual chlorine | 4 mg/L or less |

* Maximum limit suggested by Noritz.

Follow-up Service

Requesting Service

First follow the instructions in the troubleshooting section (page 34 to page 35).
If the error is not corrected, contact Noritz America Technical Support at 866-766-7489.

We will need to know:

The Model(check the rating plate)
Date of purchase(see the warranty)
Details of problem(blinking error codes,
etc., in much detail as possible)
Your name, address, and telephone number
Desired date of visit

A request for service may be rejected if the Combi Boiler is installed in a location where working on the unit may be dangerous. Contact a plumber.

Warranty

A warranty registration card is included separately.
Be sure that the plumber, date of purchase and other necessary items are filled in.
Read the content carefully, and keep the warranty card in a safe place.
For repairs after the warranty period, there will be a charge on any service, and service will only be performed if the unit is deemed repairable.

Period of Time for Stocking Repair Parts

Noritz will stock repair and maintenance parts ten(10) years for this unit for the time period from the date of the original installation or end of production.

Owner's Guide

Register your Warranty online at www.noritz.com/warranty



NORITZ AMERICA CO.
11160 Grace Avenue Fountain Valley, CA 92708
Phone : 866 - 766 - 7489