

WIRE RANGE TABLE D:

CONNECTOR	COPPER		ALUMINUM	
	SOLID	STRAND	SOLID	STRAND
LINE	14-8	14-2	12-8	12-2
LOAD	14-8	14-2	12-8	12-2
EQUIP. GRND.	12-8	12-2	12-8	12-2

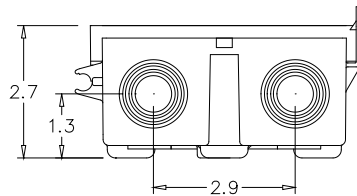
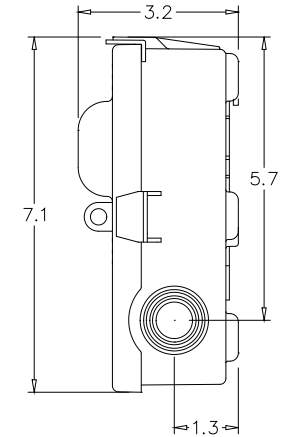
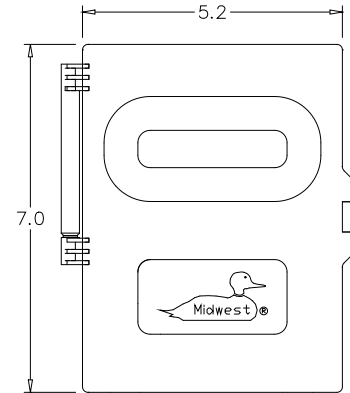
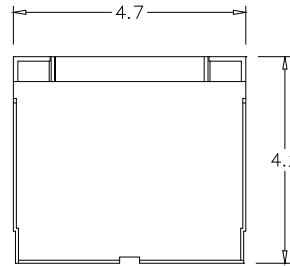
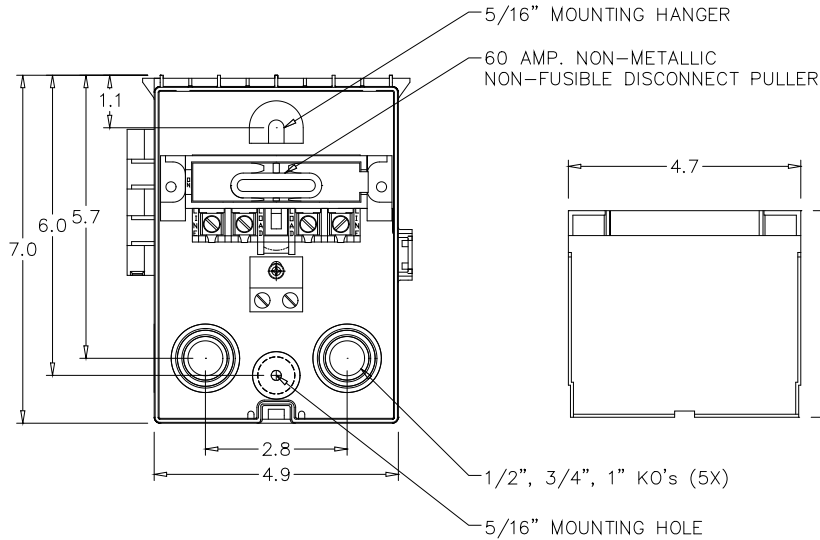
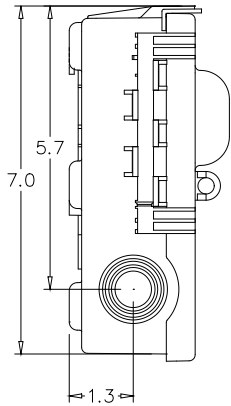

SH3

Rev.1 CR R0746662 JDE 1-11-08

MIDWEST ELECTRIC  
 PRODUCTS, INC.  
 Mankato, MN



\* = Critical To Quality  
 Unless Otherwise Specified  
 Tolerances On:  
 3 Pl. Decimals ± .010  
 2 Pl. Decimals ± .030  
 Fractions ± 1/32  
 Angles ± 1/2°  
 Holes ± .003  
 Dimensions Are In Inches

AutoCad  
 Generated  
 SCALE 1 : 1  
 SIZE A  
 SHEET 1 OF 1

TITLE: P065P1  
 OUTLINE DRAWING  
 DWG NO: 265A6313