

# Advanced Installation Guide

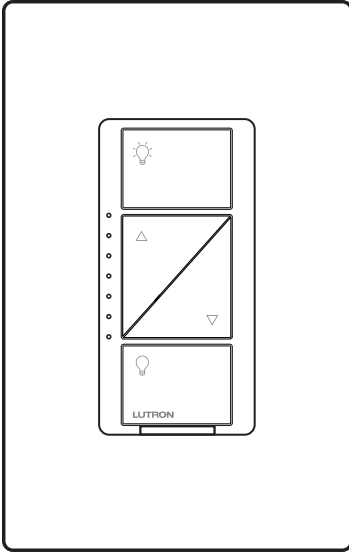

**In-wall dimmer  
PD-6WCL**

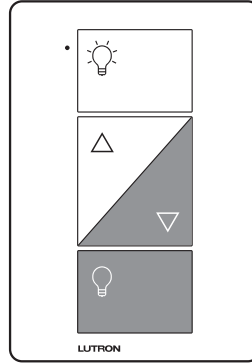

**Plug-in lamp dimmer  
PD-3PCL**

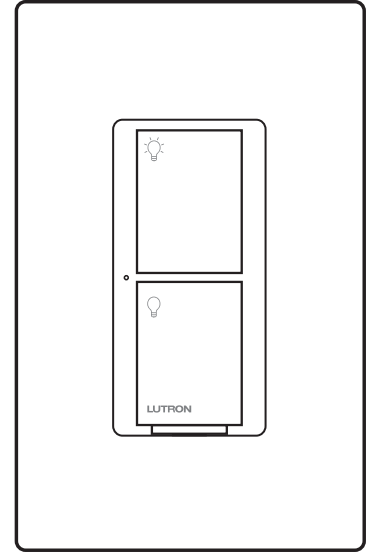

**In-wall switch  
PD-5WS-DV**

**Thank you** for purchasing Caséta™ Wireless from Lutron. This document will guide you through several additional installation topics beyond those covered in the quick-start guide included with your product.

## Table of Contents

<b>3-Way Installation - Caséta™ Wireless In-Wall Dimmer with Pico® Remote Control:</b> If you have two switches controlling your lights, follow this procedure to install your in-wall dimmer. ....	Page 2 - 5
<b>3-Way Installation - Caséta™ Wireless In-Wall Switch with Pico® Remote Control:</b> If you have two switches controlling your lights, you can follow this procedure to install your in-wall switch. ....	Page 6 - 9
<b>3-Way Installation - Caséta™ Wireless In-Wall Switch with Mechanical Toggle Switch:</b> If you have two switches controlling your lights, you can follow this procedure to install your in-wall switch. ....	Page 10 - 12
<b>Multi-Location Installation - Caséta™ Wireless In-Wall Dimmer with Pico® Remote Controls:</b> If you have three or more switches controlling your lights, follow this procedure to install your in-wall dimmer. ....	Page 13 - 17
<b>Multi-Location Installation - Caséta™ Wireless In-Wall Switch with Pico® Remote Controls:</b> If you have three or more switches controlling your lights, follow this procedure to install your in-wall switch. ....	Page 18 - 22
<b>Adjusting Low-End Trim on a Caséta™ Wireless In-Wall Dimmer:</b> Follow this procedure if you experience performance issues such as flickering, flashing or other abnormal light behavior when your in-wall dimmer is at a low light level. ....	Page 23
<b>Adjusting High-End Trim on a Caséta™ Wireless In-Wall Dimmer:</b> Follow this procedure to adjust the maximum light output allowed by your in-wall dimmer. ....	Page 24
<b>Adjusting Low-End Trim on a Caséta™ Wireless Plug-In Lamp Dimmer:</b> Follow this procedure if you experience performance issues such as flickering, flashing or other abnormal light behavior when your plug-in lamp dimmer is at a low light level. ....	Page 25
<b>Adjusting High-End Trim on a Caséta™ Wireless Plug-In Lamp Dimmer:</b> Follow this procedure to adjust the maximum light output allowed by your plug-in lamp dimmer. ....	Page 26
<b>Converting a Caséta™ Wireless Plug-In Lamp Dimmer to a Switch to Control Non-Dim Loads (Lights Only):</b> Follow this procedure if you would like your plug-in lamp dimmer to act as a switch for non-dimmable lighting loads. ....	Page 27
<b>Removing Paired Pico® Remote Controls from a Caséta™ Wireless Dimmer:</b> Follow this procedure if you need to remove paired Pico® remote controls or reset your dimmer to its factory default settings. ....	Page 28
<b>Removing Paired Pico® Remote Controls from a Caséta™ Wireless In-Wall Switch:</b> Follow this procedure if you need to remove paired Pico® remote controls or reset your switch to its factory default settings. ....	Page 29
<b>Removing Paired Pico® Remote Controls from a Lutron® Shade:</b> Follow this procedure if you need to remove paired Pico® remote controls from a Lutron® Shade. ....	Page 30-31
<b>Changing the Favorite Light Level on a Pico® Remote Control:</b> Follow this procedure to change the light level your dimmer recalls when you press the "Favorite" button on your Pico® remote control. ....	Page 32
<b>Installing a LUT-MLC Load Adapter with a Caséta™ Wireless In-Wall Switch:</b> The LUT-MLC is provided to help ensure proper operation of the Caséta™ Wireless switch with LED, CFL, fluorescent, and ELV lighting loads. ....	Page 33
<b>Troubleshooting</b> .....	Page 34

### 1 Identify existing wiring

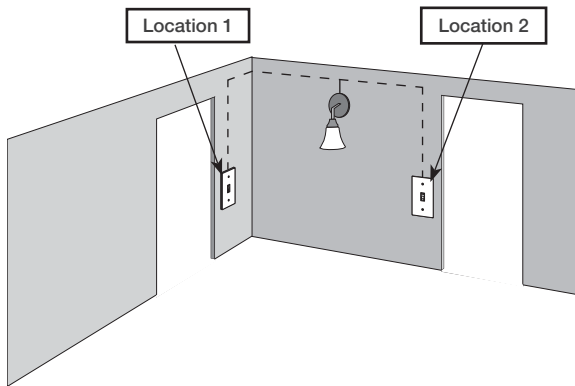

Two switches control the lights (3-way installation)

#### Important note:

- If one switch controls the lights (single-pole installation) See quick-start guide that came with your dimmer
- If three or more switches control the lights (multi-location installation) See page 13 for details

### 2 What you need for a 3-way installation



In-wall dimmer  
PD-6WCL

+



Claro® Wallplate  
CW-1

+



Pico® remote control  
with wall-mounting kit  
PJ2-WALL

### 3 Choose a location for your Caséta™ Wireless dimmer

Choose which location you want the Caséta™ Wireless dimmer installed in. This will be Location 1.

### 4 Turn power off at circuit breaker

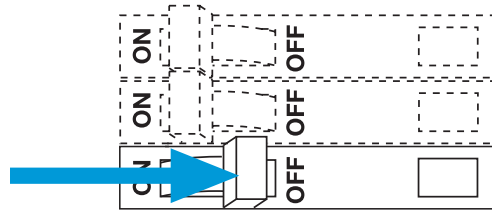

**WARNING! Shock Hazard.** May result in serious injury or death. Turn off power at circuit breaker before installing the unit.

### 5 Remove existing switch from wall

Location 1

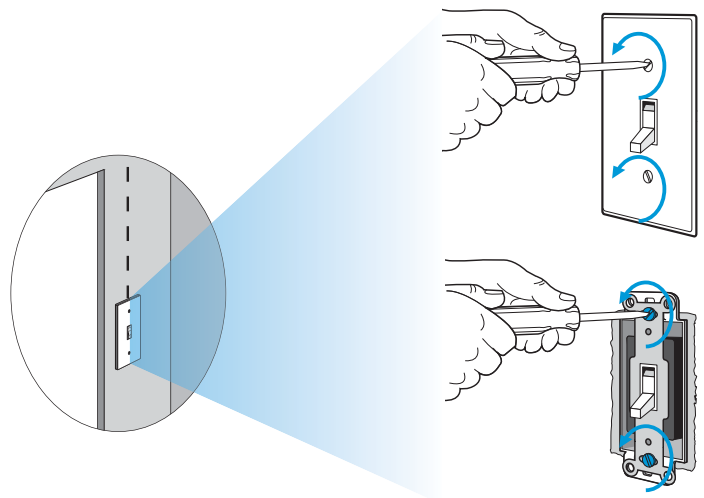

### 6 Tag and disconnect wires from the existing switch

Location 1

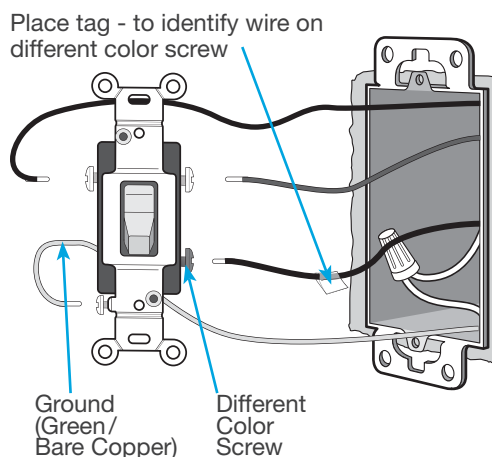

### 7 Remove side sections (if necessary)

When installing more than one Caséta™ Wireless dimmer in the same wallbox, it is necessary to remove inner side sections prior to wiring. See image and chart below for more information.

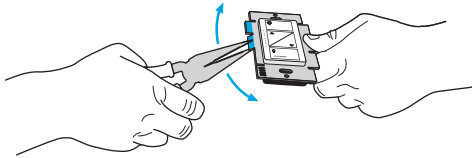

**Do not** remove outside side sections on dimmers at the end of gang.

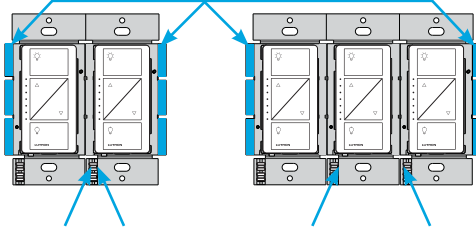

Each dimmer has inside side sections removed.

Dimmer in the middle has all side sections removed.

### Important note:

Removing side sections reduces the dimmer's maximum wattage rating. See the chart below for maximum wattage information.

CFL/LED Total Wattage	Incandescent/Halogen Total Wattage		
	A	B	C
0 W	+ 600 W	500 W	400 W
1 W – 25 W	+ 500 W	400 W	300 W
26 W – 50 W	+ 400 W	300 W	200 W
51 W – 75 W	+ 300 W	200 W	100 W
76 W – 100 W	+ 200 W	100 W	50 W
101 W – 125 W	+ 100 W	50 W	0 W
126 W – 150 W	+ 0 W	0 W	0 W

### 8 Connect the Caséta™ Wireless dimmer

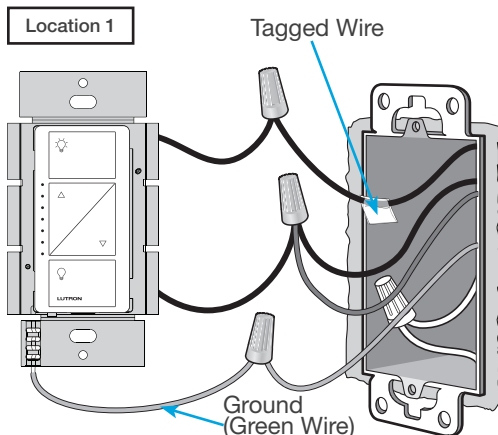

### 9 Mount the Caséta™ Wireless dimmer

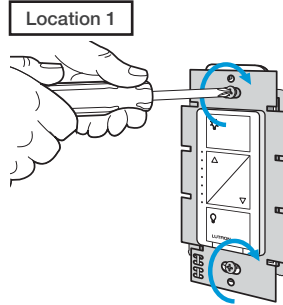

### 10 Attach the wallplate

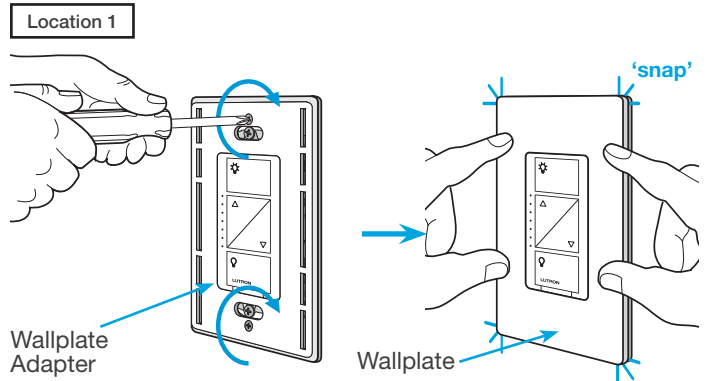

### 11 Remove existing switch from wall at Location 2

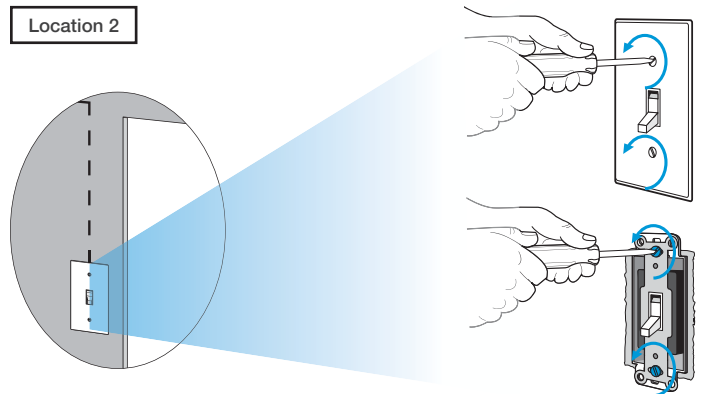

### 12 Tag and disconnect wires from the switch

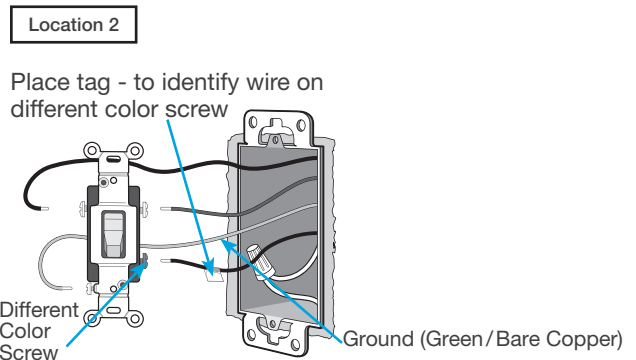

**13** Connect the wires

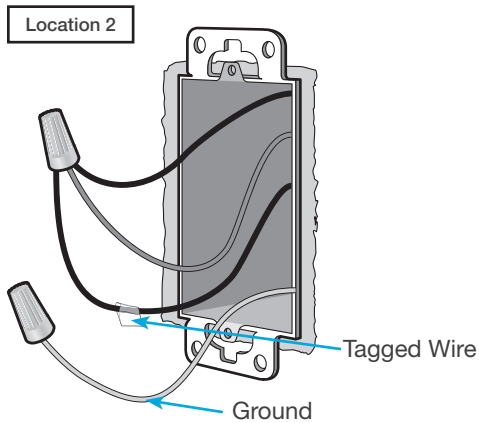

**14** Attach the wallplate bracket and Pico® remote control

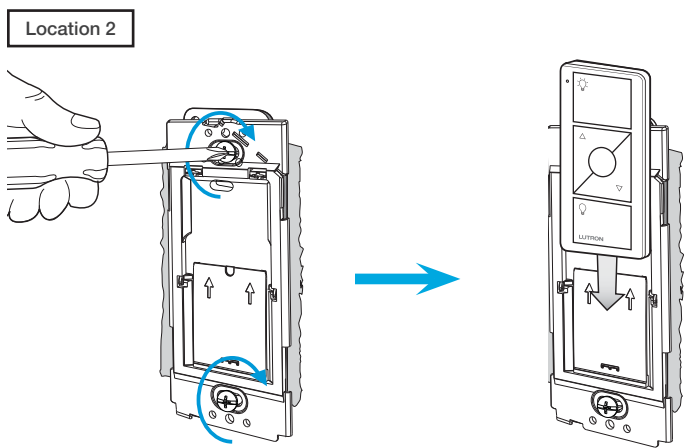

**15** Attach the wallplate

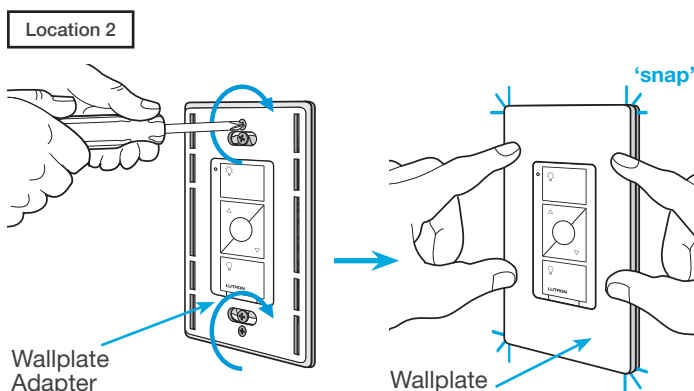

**16** Turn power on at circuit breaker

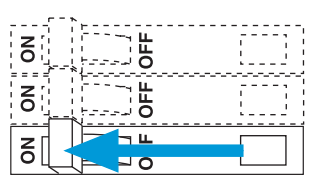

Pairing the dimmer and Pico® remote control

**17** Press and hold "Off" button on dimmer

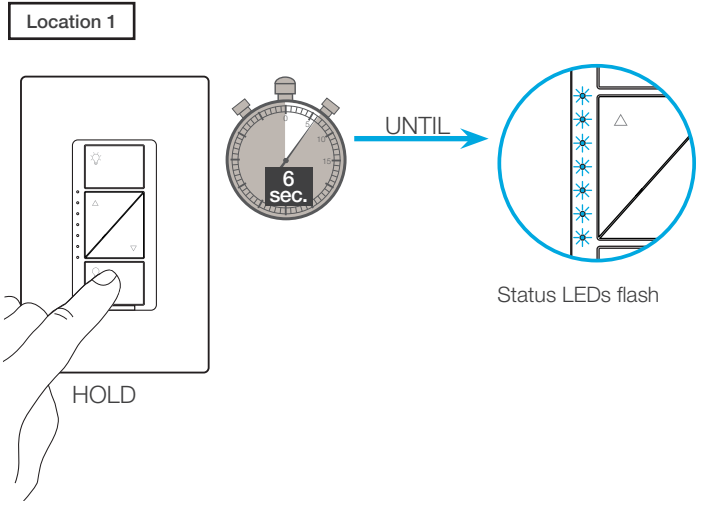

**18** Press and hold "Off" button on remote control

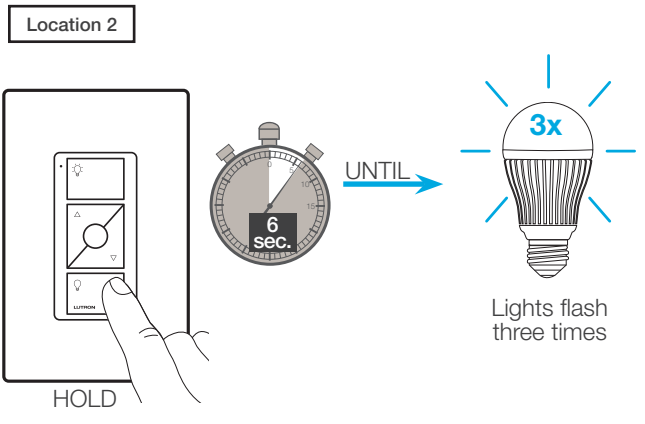

**19** Pair additional remote controls

Repeat steps 17 and 18 to pair additional remote controls.

Schematic Diagram

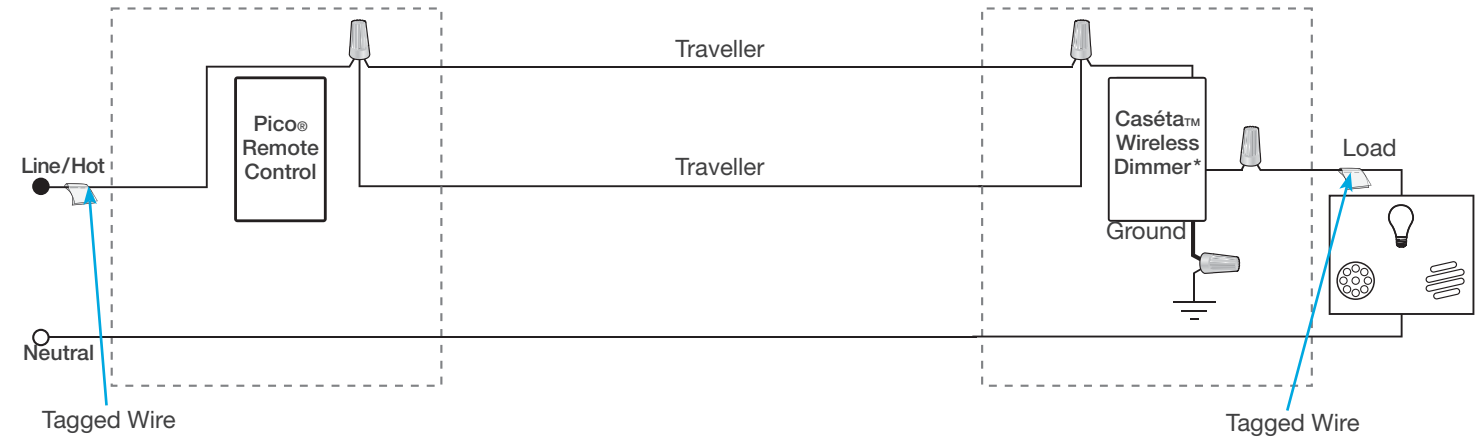

\* Dimmer may be installed in either location.

### 1 Identify existing wiring

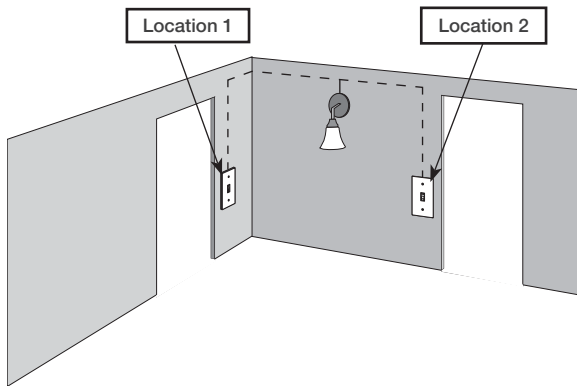

Two switches control the lights (3-way installation)

#### Important note:

- If one switch controls the lights (single-pole installation) See quick-start guide that came with your switch
- If three or more switches control the lights (multi-location installation) See page 18 for details

### 2 What you need for a 3-way installation



In-wall switch  
PD-5WS-DV

+



Pico® remote control  
PJ2-2B

+



Wallplate Bracket  
PICO-WBX-ADAPT

+



Two Claro® Wallplates  
CW-1

### 3 Choose a location for your Caséta™ Wireless switch

Choose which location you want the Caséta™ Wireless switch installed in. This will be Location 1.

### 4 Turn power off at circuit breaker

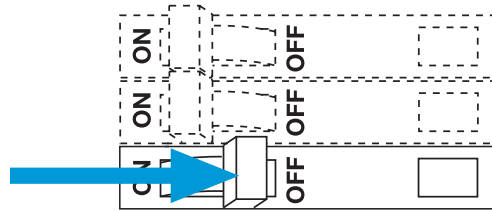

**WARNING! Shock Hazard.** May result in serious injury or death. Turn off power at circuit breaker before installing the unit.

### 5 Remove existing switch from wall

Location 1

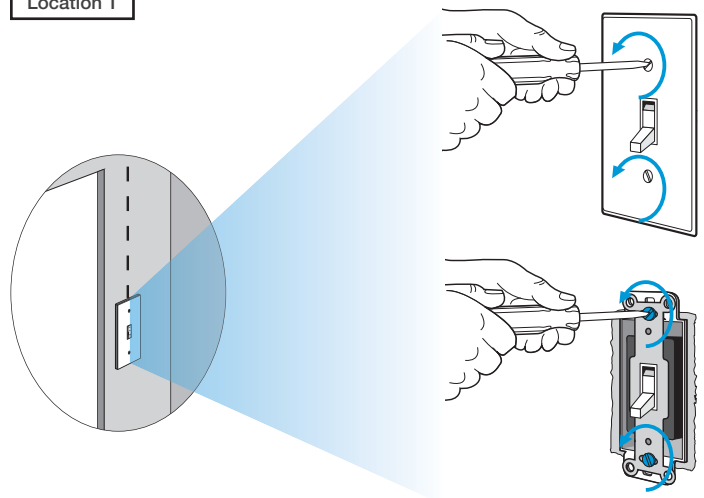

### 6 Tag and disconnect wires from the existing switch

Location 1

Place tag - to identify wire on different color screw

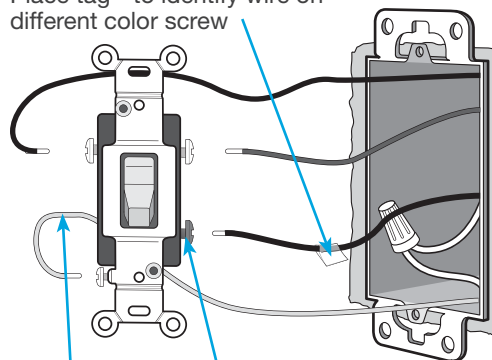

Ground  
(Green/  
Bare Copper)

Different  
Color  
Screw

### 7 Remove side sections (if necessary)

When installing more than one Caséta™ Wireless switch in the same wallbox, it is necessary to remove inner side sections prior to wiring. See image and chart below for more information.

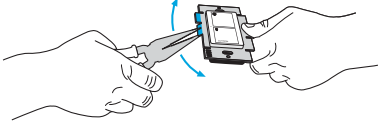

**Do not** remove outside side sections on switches at the end of gang.

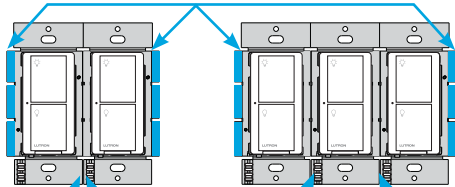



Each switch has inside side sections removed.

Switch in the middle has all side sections removed.

### Important note:

Removing side sections reduces the switch's maximum wattage rating. See the chart below for maximum wattage information.

			
<b>PD-5WS-DV (120 V~)</b>	<b>A</b>	<b>B</b>	<b>C</b>
CFL/LED	5 A	4 A	3 A
Halogen/incandescent	600 W	450 W	350 W
Electronic Low-Voltage	600 W	450 W	350 W
Magnetic Low-Voltage <sup>1</sup>	600 VA/475 W	450 VA/350 W	350 VA/275 W
Fluorescent <sup>2</sup>	5 A	4 A	3 A
General Purpose Fan	3 A	3 A	3 A
<b>PD-5WS-DV (277 V~)</b>	<b>A</b>	<b>B</b>	<b>C</b>
CFL/LED	5 A	4 A	3 A
Halogen/incandescent	1350 W	1100 W	800 W
Electronic Low-Voltage	1350 W	1100 W	800 W
Magnetic Low-Voltage <sup>1</sup>	1350 VA/1075 W	1100 VA/875 W	800 VA/625 W
Fluorescent <sup>2</sup>	5 A	4 A	3 A

<sup>1</sup> The maximum lamp wattage is determined by the efficiency of the transformer, with 70% – 85% as typical. For actual transformer efficiency, contact either the fixture or transformer manufacturer. The total VA rating of the transformer(s) shall not exceed the VA rating of the in-wall switch.

<sup>2</sup> The in-wall switch is UL Listed for use with all magnetic and electronic fluorescent ballasts.

### 8 Connect the new Caséta™ Wireless switch

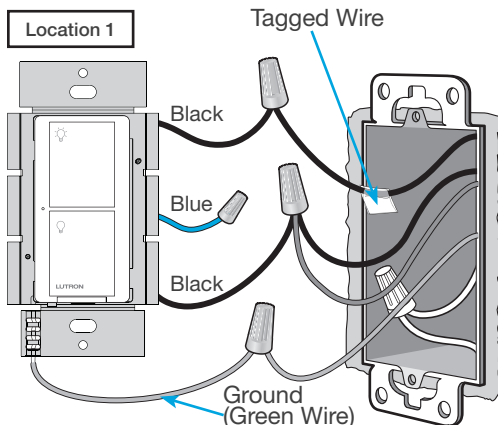

### 9 Mount the Caséta™ Wireless switch

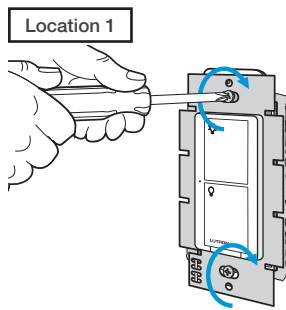

### 10 Attach the wallplate

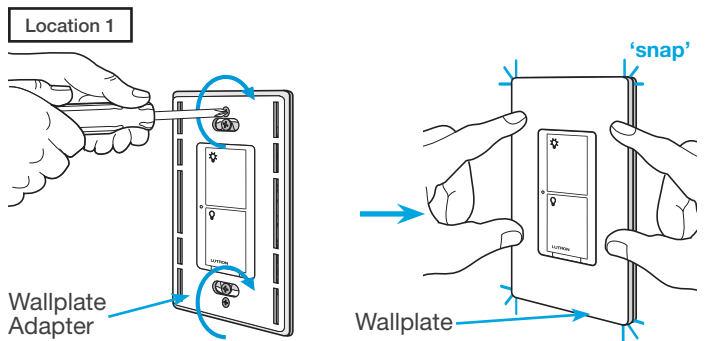

### 11 Remove existing switch from wall at Location 2

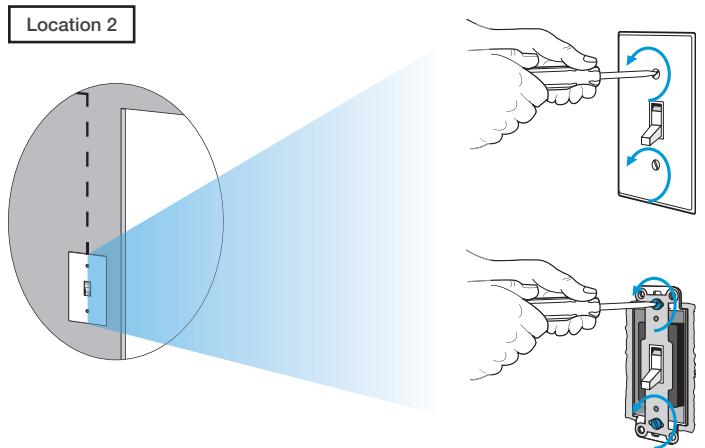

### 12 Tag and disconnect wires from the existing switch

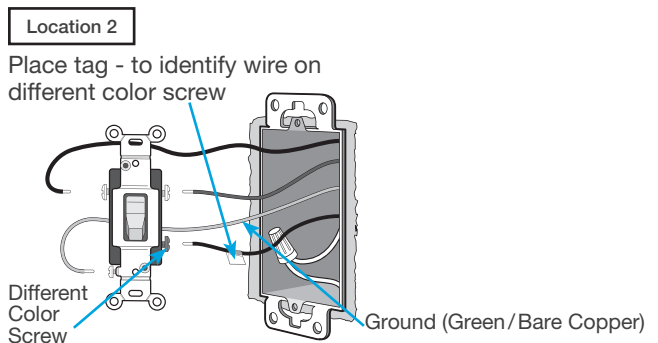

**13** Connect the wires

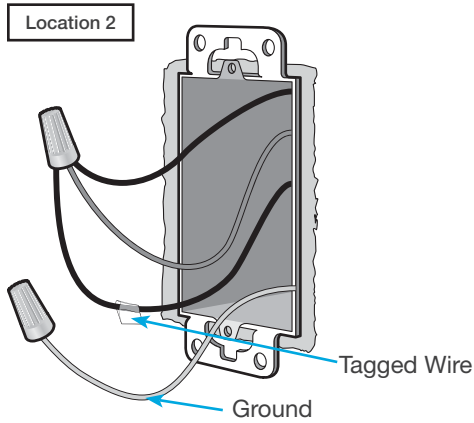

**14** Attach the wallplate bracket and Pico® remote control

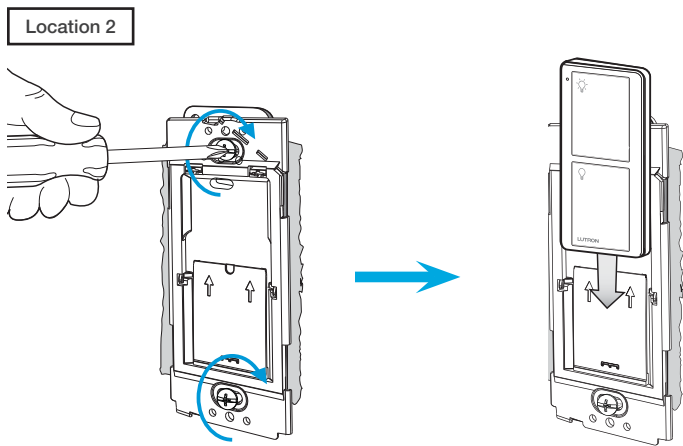

**15** Attach the wallplate

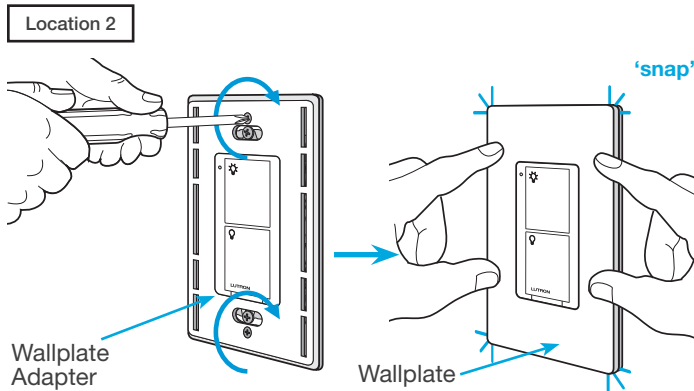

**16** Turn power on at circuit breaker

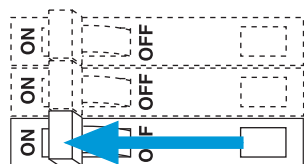

Pairing the switch and Pico® remote control

**17** Press and hold "Off" button on switch

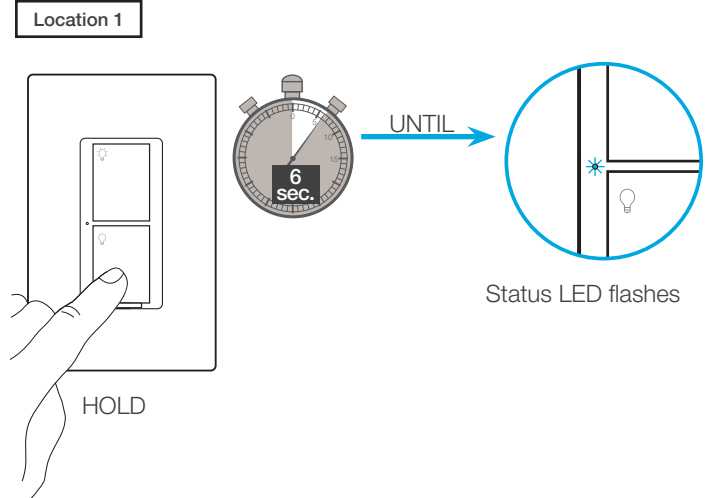

**18** Press and hold "Off" button on remote control

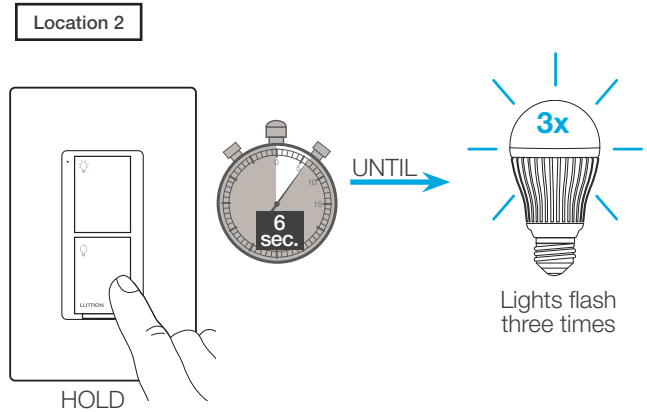

**19** Pair additional remote controls

Repeat steps 17 and 18 to pair additional remote controls.



Schematic Diagram

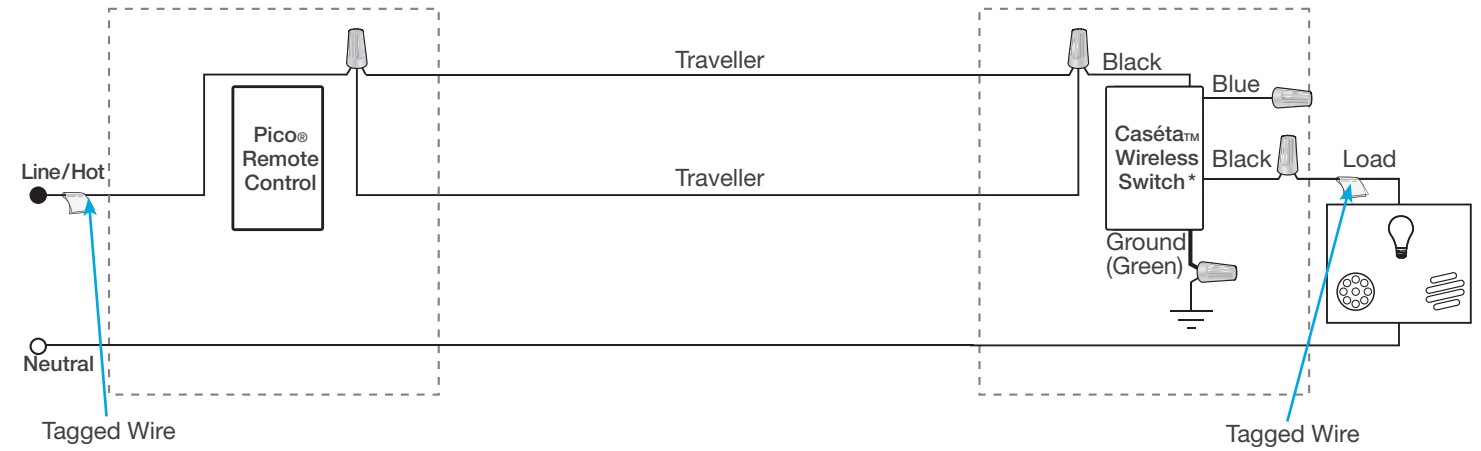

\* Switch may be installed in either location.

### 1 Identify existing wiring

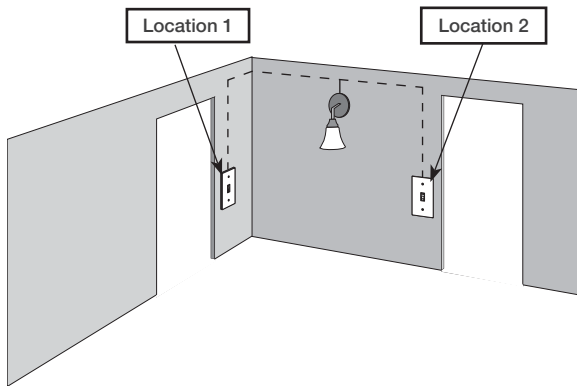

Two switches control the lights (3-way installation)

#### Important note:

- If one switch controls the lights (single-pole installation) See quick-start guide that came with your switch
- If three or more switches control the lights (multi-location installation) See page 18 for details

### 2 What you need for a 3-way installation



In-wall switch  
PD-5WS-DV

+



Claro® Wallplate  
CW-1

+

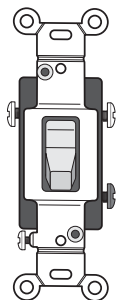

Existing mechanical  
toggle switch

### 3 Choose a location for your Caséta™ Wireless switch

Choose which location you want the Caséta™ Wireless switch installed in. This will be Location 1.

### 4 Turn power off at circuit breaker

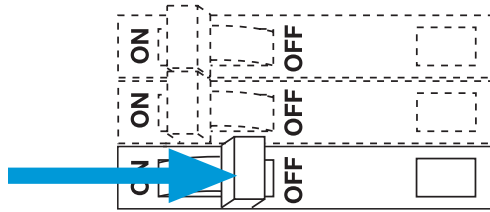

**WARNING! Shock Hazard.** May result in serious injury or death. Turn off power at circuit breaker before installing the unit.

### 5 Remove existing switch from wall

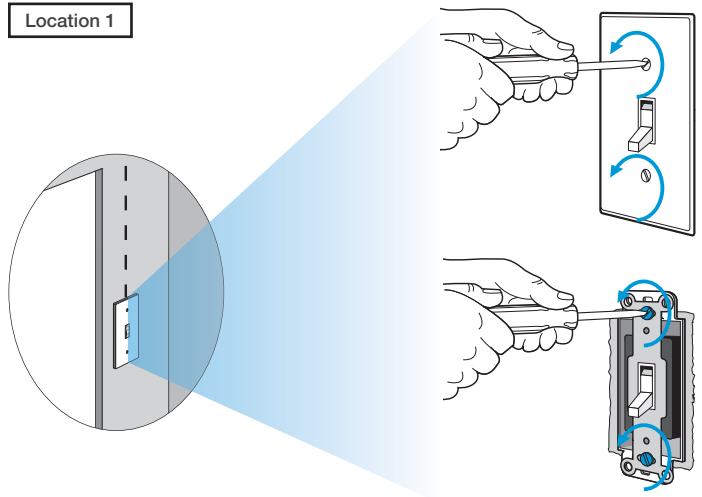

### 6 Tag and disconnect wires from the existing switch

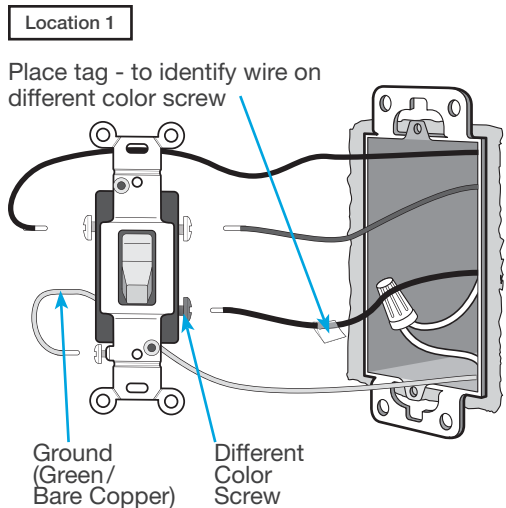

### 7 Remove side sections (if necessary)

When installing more than one Caséta™ Wireless switch in the same wallbox, it is necessary to remove inner side sections prior to wiring. See image and chart below for more information.

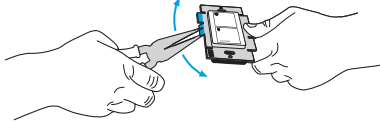

**Do not** remove outside side sections on switches at the end of gang.

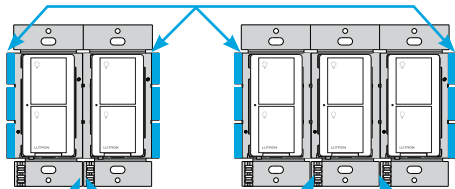

Each switch has inside side sections removed.

Switch in the middle has all side sections removed.

### Important note:

Removing side sections reduces the switch's maximum wattage rating. See the chart below for maximum wattage information.

	A	B	C
<b>PD-5WS-DV (120 V~)</b>	<b>A</b>	<b>B</b>	<b>C</b>
CFL/LED	5 A	4 A	3 A
Halogen/incandescent	600 W	450 W	350 W
Electronic Low-Voltage	600 W	450 W	350 W
Magnetic Low-Voltage <sup>1</sup>	600 VA/475 W	450 VA/350 W	350 VA/275 W
Fluorescent <sup>2</sup>	5 A	4 A	3 A
General Purpose Fan	3 A	3 A	3 A
<b>PD-5WS-DV (277 V~)</b>	<b>A</b>	<b>B</b>	<b>C</b>
CFL/LED	5 A	4 A	3 A
Halogen/incandescent	1350 W	1100 W	800 W
Electronic Low-Voltage	1350 W	1100 W	800 W
Magnetic Low-Voltage <sup>1</sup>	1350 VA/1075 W	1100 VA/875 W	800 VA/625 W
Fluorescent <sup>2</sup>	5 A	4 A	3 A

<sup>1</sup> The maximum lamp wattage is determined by the efficiency of the transformer, with 70% – 85% as typical. For actual transformer efficiency, contact either the fixture or transformer manufacturer. The total VA rating of the transformer(s) shall not exceed the VA rating of the in-wall switch.

<sup>2</sup> The in-wall switch is UL Listed for use with all magnetic and electronic fluorescent ballasts.

### 8 Connect the new Caséta™ Wireless switch

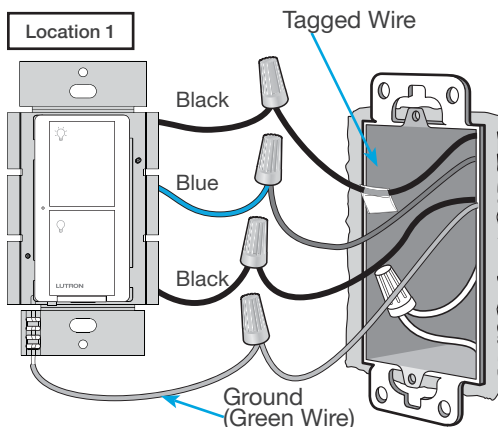

### 9 Mount the Caséta™ Wireless switch

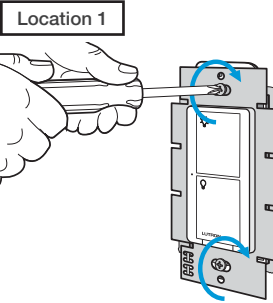

### 10 Attach the wallplate

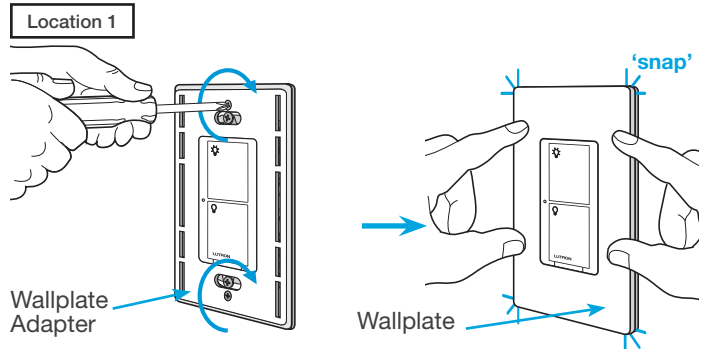

### 11 Remove existing toggle switch from wall at Location 2

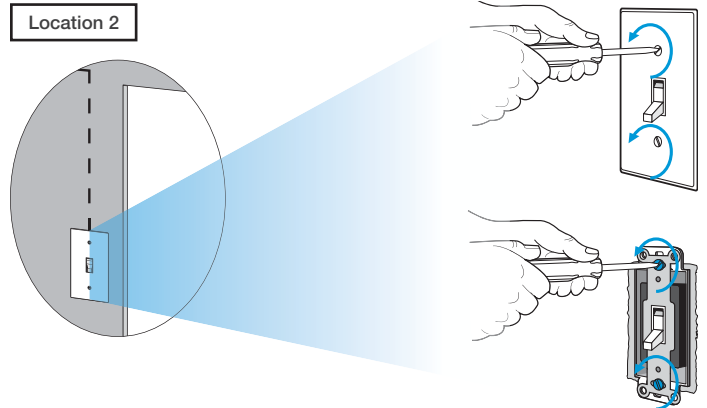

### 12 Modify wiring for existing toggle switch

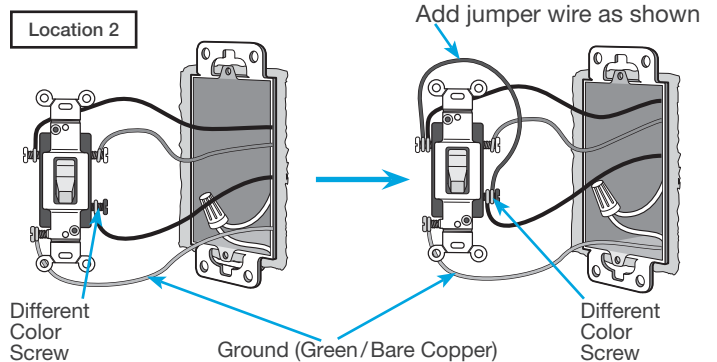

**13 Remount existing switch**

Location 2

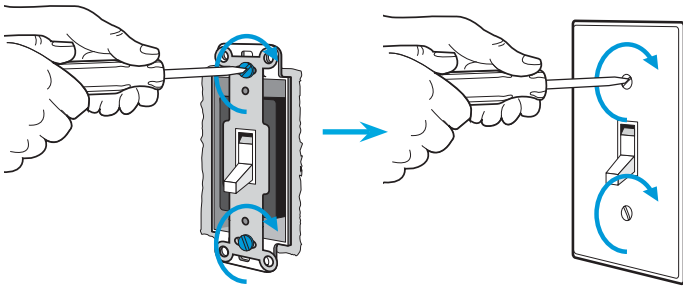

**14 Turn power on at circuit breaker**

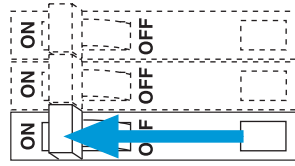

**Important note: Pico® remote control (optional)**

If you would like to pair a Pico® remote control to the Caséta™ Wireless in-wall switch, please follow the procedure described in the quick-start guide that came with your switch.

**Schematic Diagram**

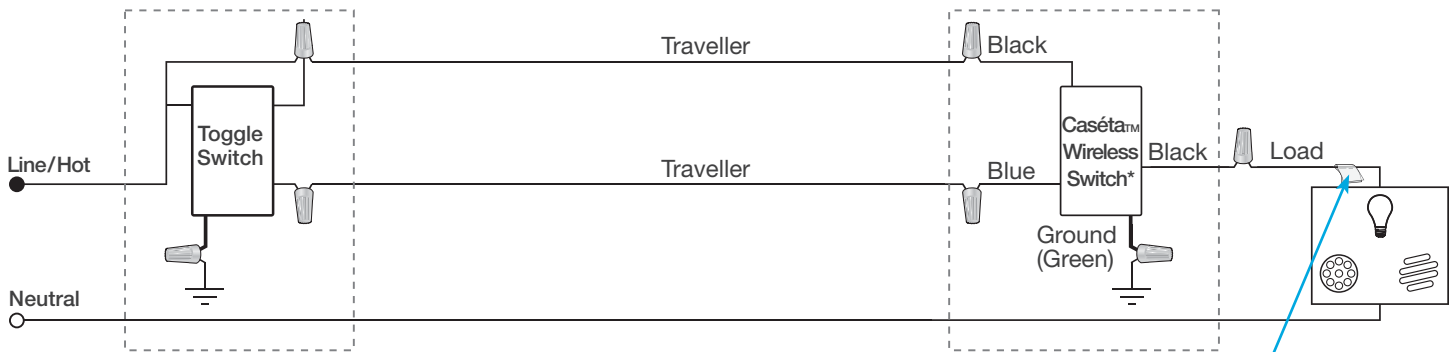

\* Switch may be installed in either location.

Tagged Wire

### 1 Identify existing wiring

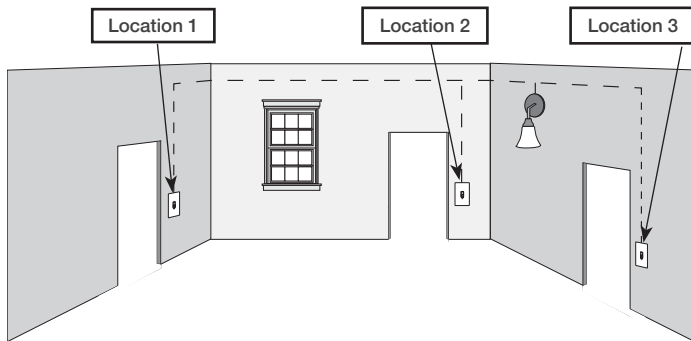

Three or more switches control the lights (multi-location installation)

#### Important note:

- If one switch controls the lights (single-pole installation) See quick-start guide that came with your dimmer
- If two switches control the lights (3-way installation) See page 2 for details

### 2 What you need for a multi-location installation



In-wall dimmer PD-6WCL or P-PKG1W

+



Claro® Wallplate CW-1

+



Two Pico® remote controls with wall-mounting kits PJ2-WALL



### 3 Choose a location for your Caséta™ Wireless dimmer

**NOTE:** There will be two different types of existing switches in this application. Locations 1 and 3 will use 3-way switches (three screws which control the lights, plus one ground screw) and Location 2 will use a 4-way switch (four screws which control the lights, plus one ground screw). For easiest installation, we recommend replacing one of the 3-way switches with your dimmer (Locations 1 or 3). In this example, we will use Location 1.

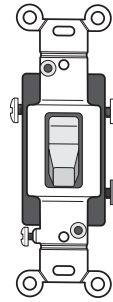

3-Way Switch  
Locations 1 and 3

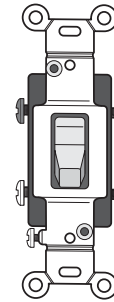

4-Way Switch  
Location 2

### 4 Turn power off at circuit breaker

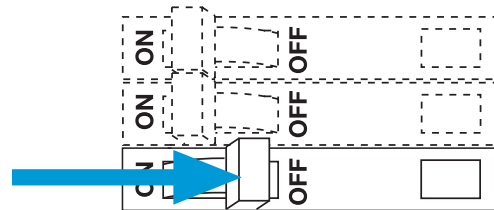

**WARNING! Shock Hazard.** May result in serious injury or death. Turn off power at circuit breaker before installing the unit.

### 5 Remove existing switch from wall at Location 1

Location 1

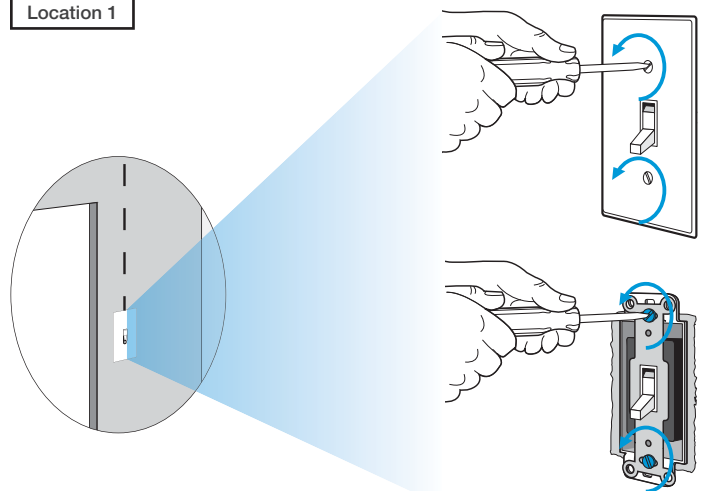

### 6 Tag and disconnect wires from the existing switch

Location 1

Place tag - to identify wire on different color screw

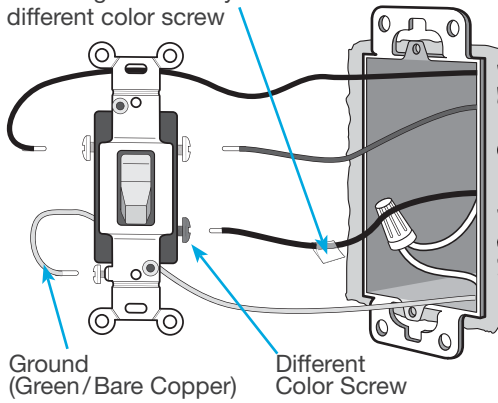

### 7 Remove side sections (if necessary)

When installing more than one Caséta™ Wireless dimmer in the same wallbox, it is necessary to remove inner side sections prior to wiring. See image and chart below for more information.

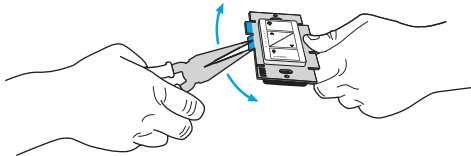

**Do not** remove outside side sections on dimmers at the end of gang.

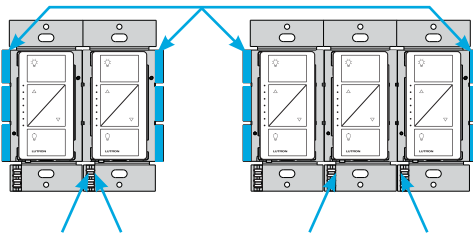

Each dimmer has inside side sections removed.

Dimmer in the middle has all side sections removed.

### Important note:

Removing side sections reduces the dimmer's maximum wattage rating. See the chart below for maximum wattage information.

CFL/LED Total Wattage	Incandescent/Halogen Total Wattage		
	A	B	C
0 W	+ 600 W	500 W	400 W
1 W – 25 W	+ 500 W	400 W	300 W
26 W – 50 W	+ 400 W	300 W	200 W
51 W – 75 W	+ 300 W	200 W	100 W
76 W – 100 W	+ 200 W	100 W	50 W
101 W – 125 W	+ 100 W	50 W	0 W
126 W – 150 W	+ 0 W	0 W	0 W

### 8 Connect the Caséta™ Wireless dimmer

Location 1

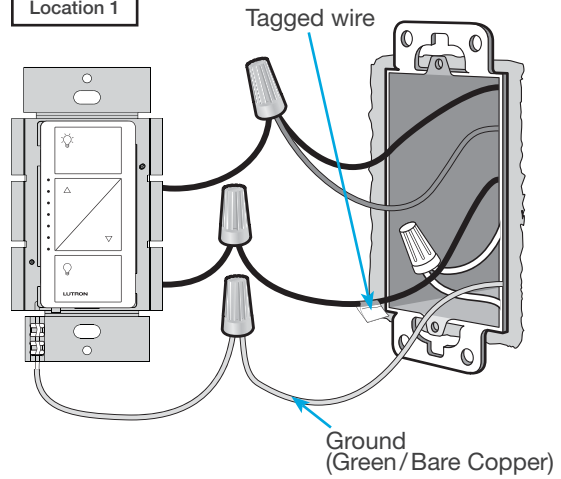

### 9 Mount the Caséta™ Wireless dimmer

Location 1

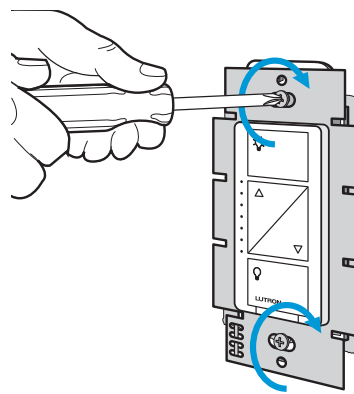

### 10 Attach the wallplate

Location 1

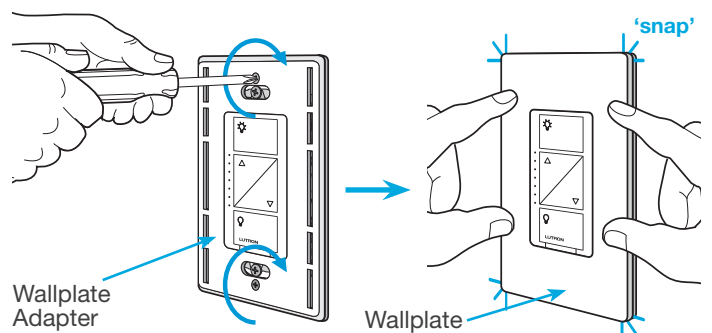

**11** Remove existing switch from wall at Location 2

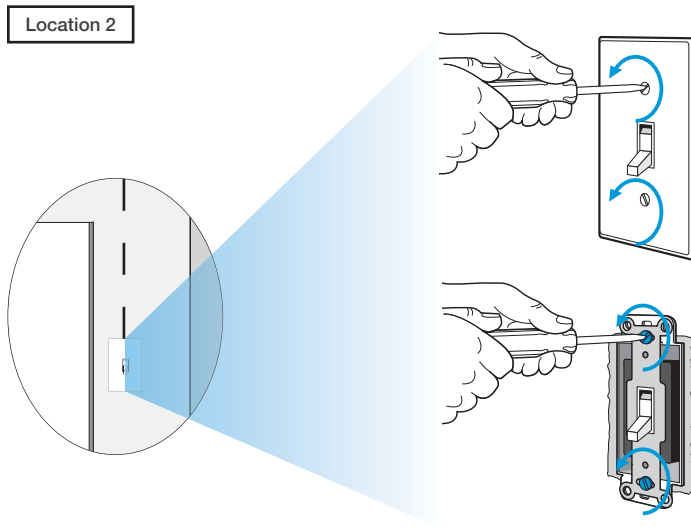

**12** Tag and disconnect wires from the existing switch

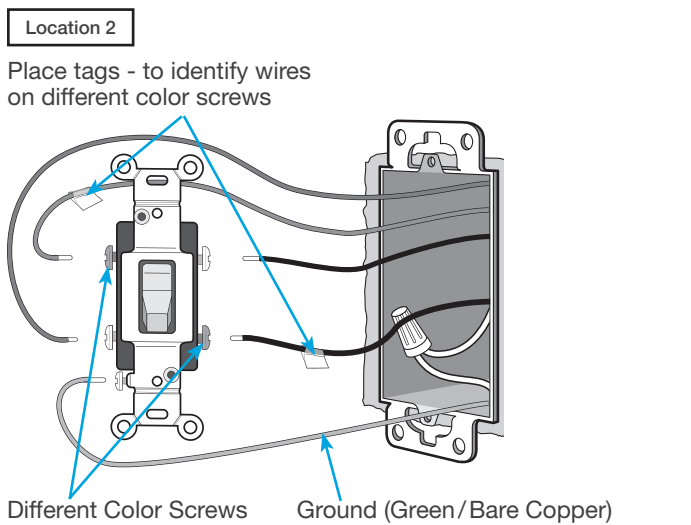

**13** Connect the wires

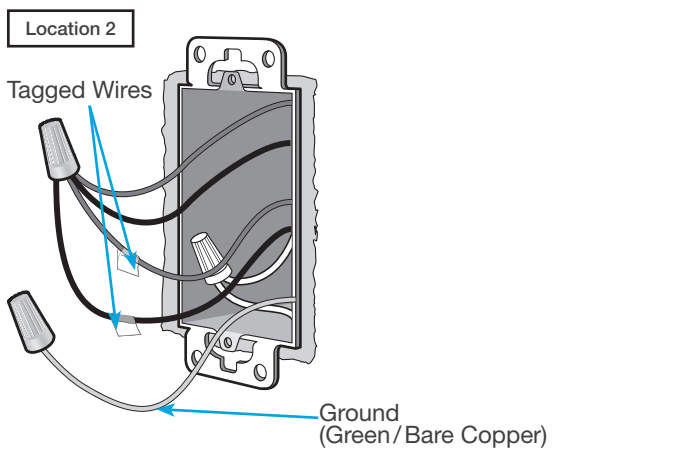

**14** Attach the wallplate bracket and Pico® remote control

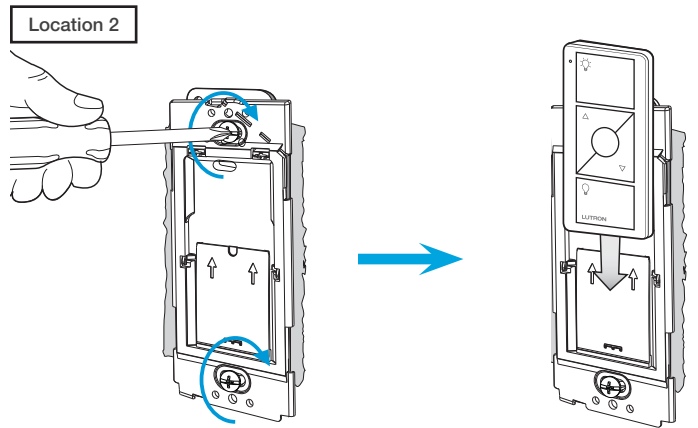

**15** Attach the wallplate

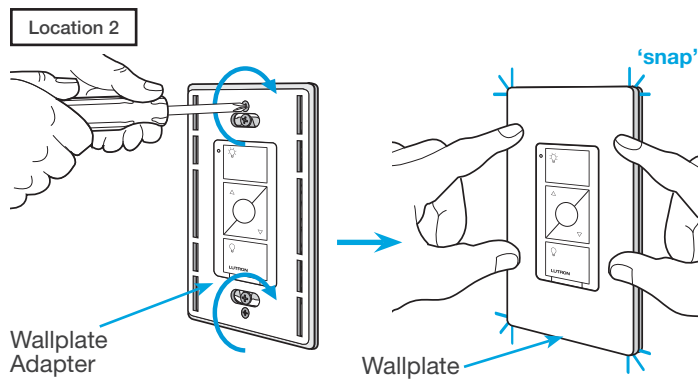

**16** Remove existing switch from wall at Location 3

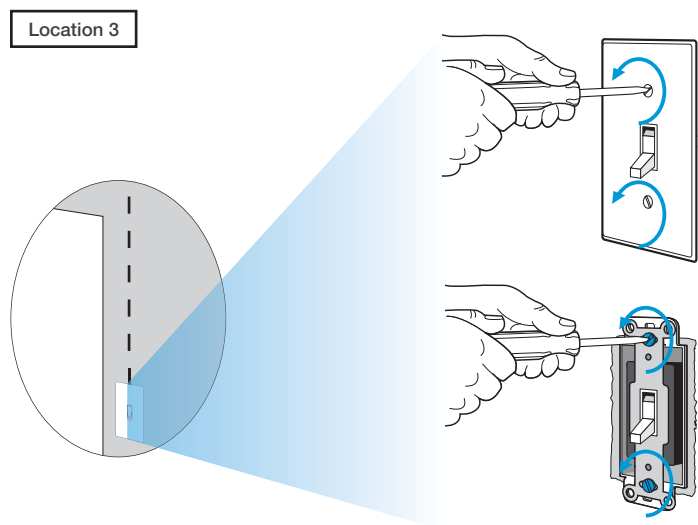

**17** Tag and disconnect wires from the switch

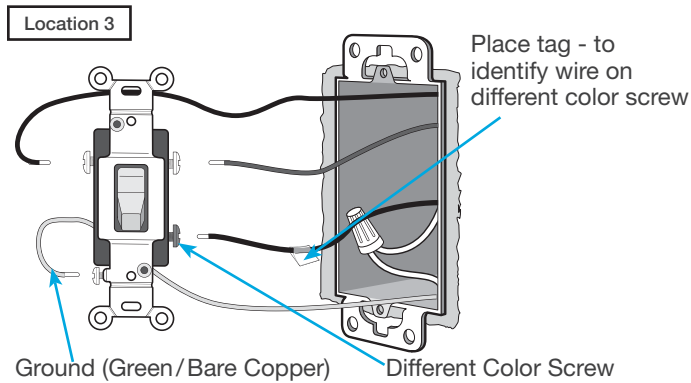

**18** Connect the wires

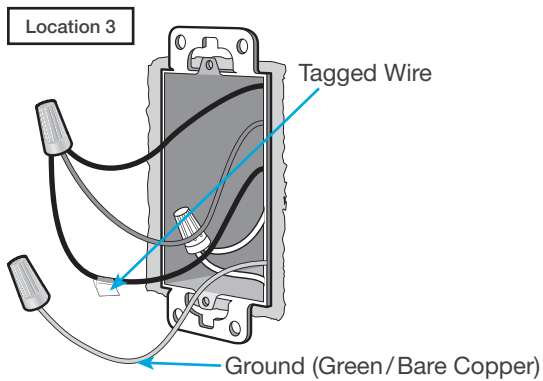

**19** Attach the wallplate bracket and Pico® remote control

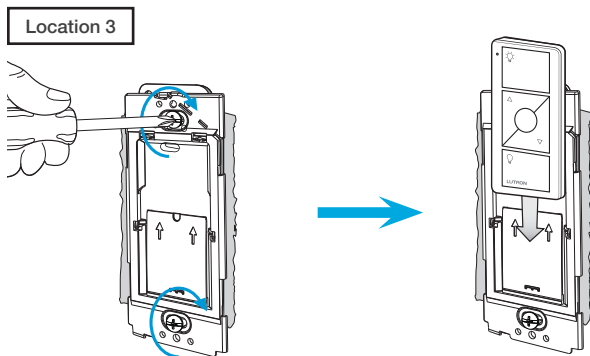

**20** Attach the wallplate

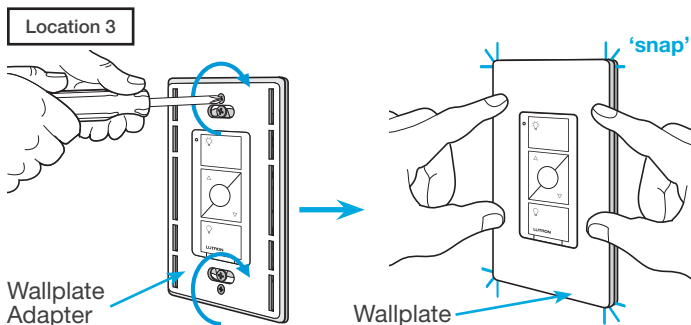

**21** Turn power on at circuit breaker

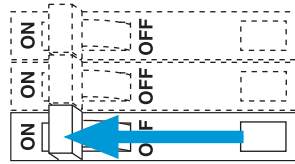

Pairing the dimmer and Pico® remote controls

**22** Press and hold "Off" button on dimmer

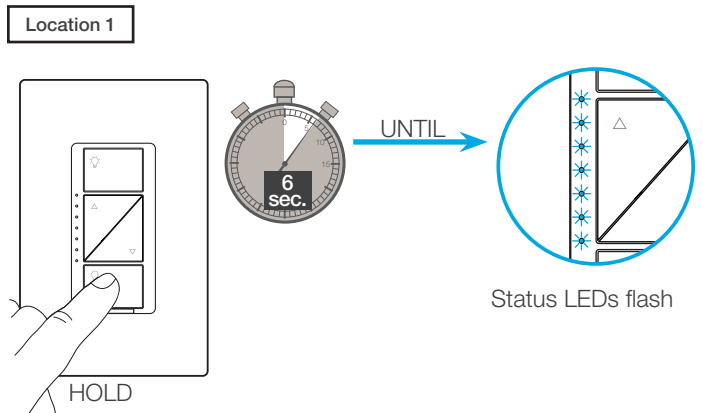

**23** Press and hold "Off" button on remote control

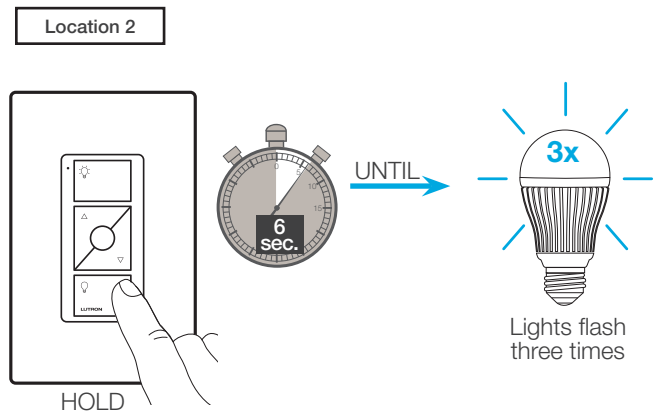

**24** Repeat for remote control at Location 3

Repeat steps 22 and 23 to pair remote control at Location 3.



Schematic Diagram

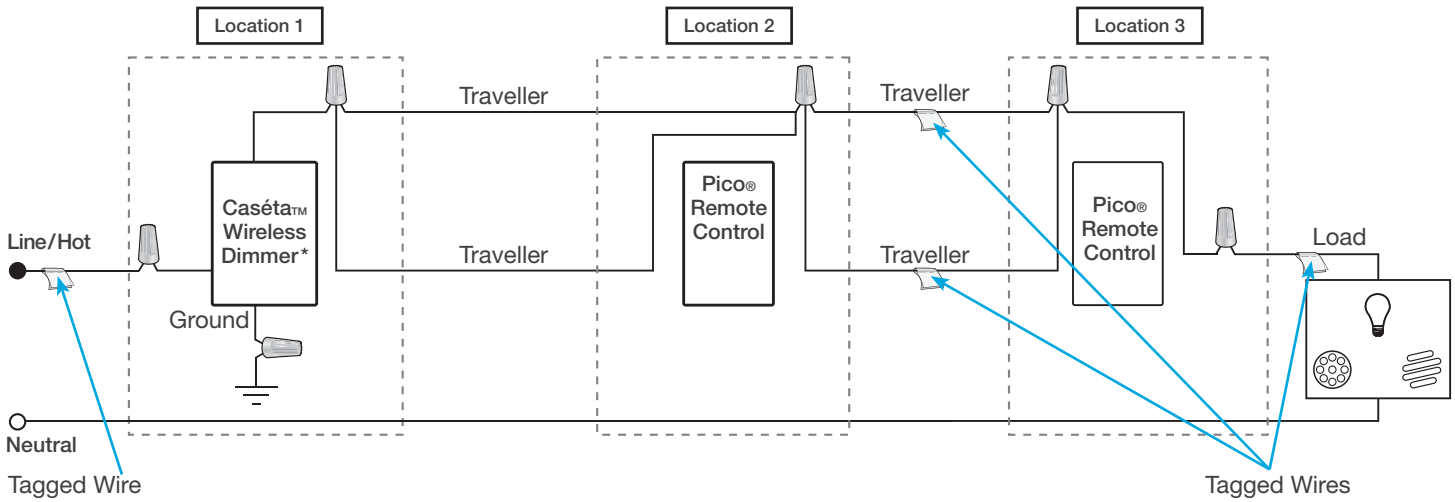

\* It is recommended to install dimmer in either Location 1 or 3.

### 1 Identify existing wiring

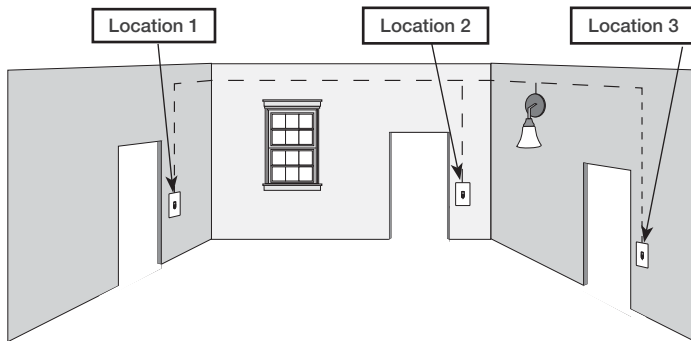

Three or more switches control the lights (multi-location installation)

#### Important note:

- If one switch controls the lights (single-pole installation) See quick-start guide that came with your switch
- If two switches control the lights (3-way installation) See page 6 or page 10 for details

### 2 What you need for a multi-location installation



In-wall switch  
PD-5WS-DV

+



Two Pico®  
remote controls  
PJ2-2B

+



Two Wallplate Brackets  
PICO-WBX-ADAPT

+



Three Claro® Wallplates  
CW-1

### 3 Choose a location for your Caséta™ Wireless switch

**NOTE:** There will be two different types of existing switches in this application. Locations 1 and 3 will use 3-way switches (three screws which control the lights, plus one ground screw) and Location 2 will use a 4-way switch (four screws which control the lights, plus one ground screw). For easiest installation, we recommend replacing one of the 3-way switches with your Caséta™ Wireless switch (Locations 1 or 3). In this example, we will use Location 1.

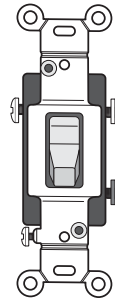

3-Way Switch  
Locations 1 and 3

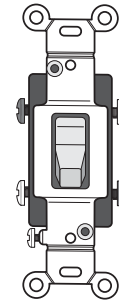

4-Way Switch  
Location 2

### 4 Turn power off at circuit breaker

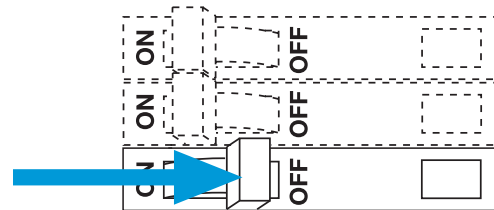

**WARNING! Shock Hazard.** May result in serious injury or death. Turn off power at circuit breaker before installing the unit.

### 5 Remove existing switch from wall at Location 1

Location 1

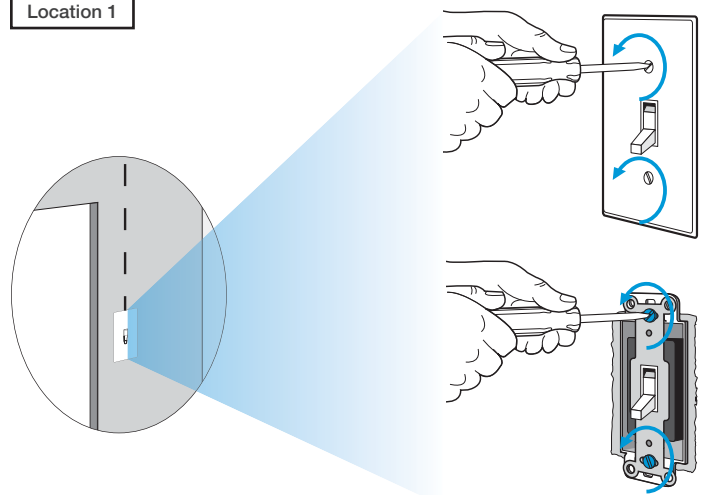

### 6 Tag and disconnect wires from the existing switch

Location 1

Place tag - to identify wire on different color screw

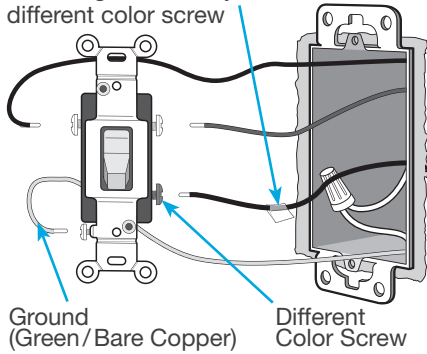

### 7 Remove side sections (if necessary)

When installing more than one Caséta™ Wireless switch in the same wallbox, it is necessary to remove inner side sections prior to wiring. See image and chart below for more information.

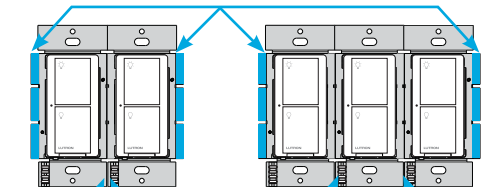
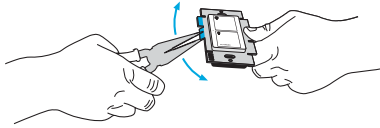

Each switch has inside side sections removed.

Switch in the middle has all side sections removed.

### Important note:

Removing side sections reduces the switch's maximum wattage rating. See the chart below for maximum wattage information.

	A	B B	B C B
<b>PD-5WS-DV (120 V~)</b>	<b>A</b>	<b>B</b>	<b>C</b>
CFL/LED	5 A	4 A	3 A
Halogen/incandescent	600 W	450 W	350 W
Electronic Low-Voltage	600 W	450 W	350 W
Magnetic Low-Voltage <sup>1</sup>	600 VA/475 W	450 VA/350 W	350 VA/275 W
Fluorescent <sup>2</sup>	5 A	4 A	3 A
General Purpose Fan	3 A	3 A	3 A
<b>PD-5WS-DV (277 V~)</b>	<b>A</b>	<b>B</b>	<b>C</b>
CFL/LED	5 A	4 A	3 A
Halogen/incandescent	1350 W	1100 W	800 W
Electronic Low-Voltage	1350 W	1100 W	800 W
Magnetic Low-Voltage <sup>1</sup>	1350 VA/1075 W	1100 VA/875 W	800 VA/625 W
Fluorescent <sup>2</sup>	5 A	4 A	3 A

<sup>1</sup> The maximum lamp wattage is determined by the efficiency of the transformer, with 70% – 85% as typical. For actual transformer efficiency, contact either the fixture or transformer manufacturer. The total VA rating of the transformer(s) shall not exceed the VA rating of the in-wall switch.

<sup>2</sup> The in-wall switch is UL Listed for use with all magnetic and electronic fluorescent ballasts.

### 8 Connect the Caséta™ Wireless switch

Location 1

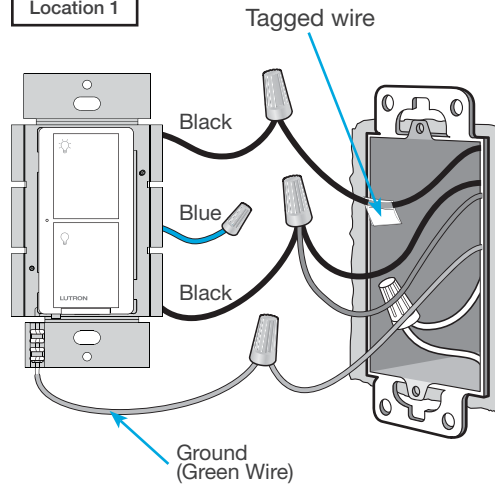

### 9 Mount the Caséta™ Wireless switch

Location 1

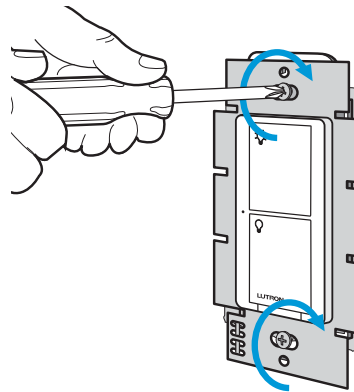

### 10 Attach the wallplate

Location 1

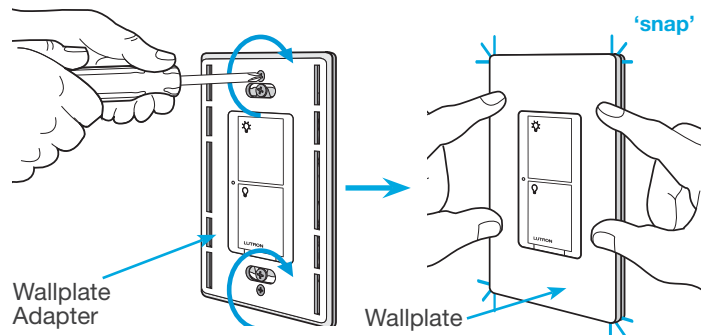

**11** Remove existing switch from wall at Location 2

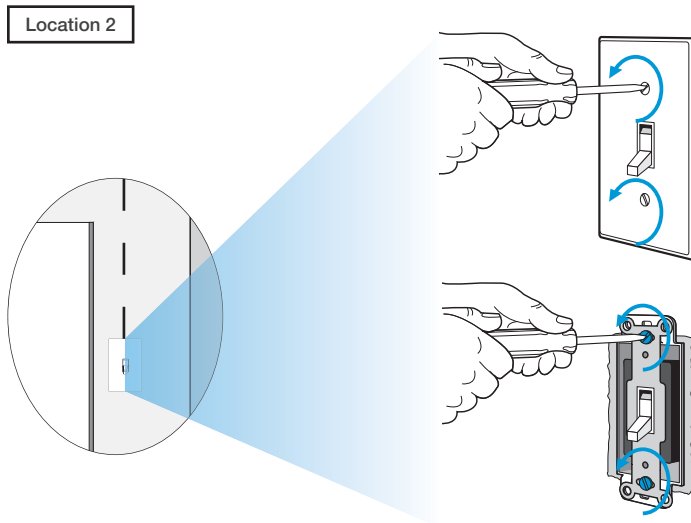

**12** Tag and disconnect wires from the existing switch

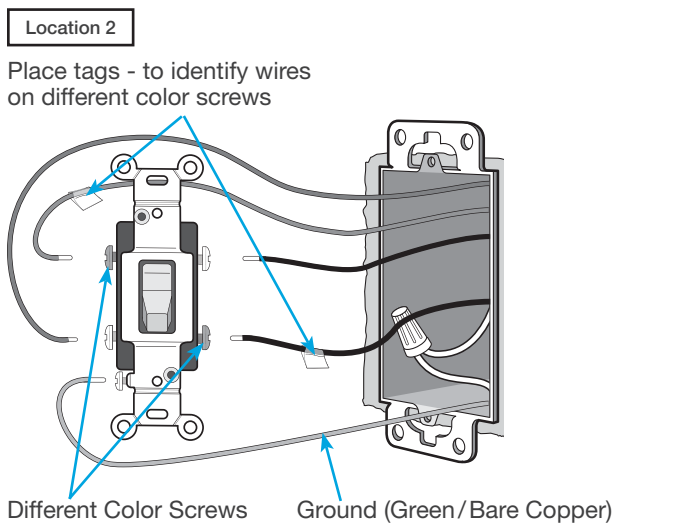

**13** Connect the wires

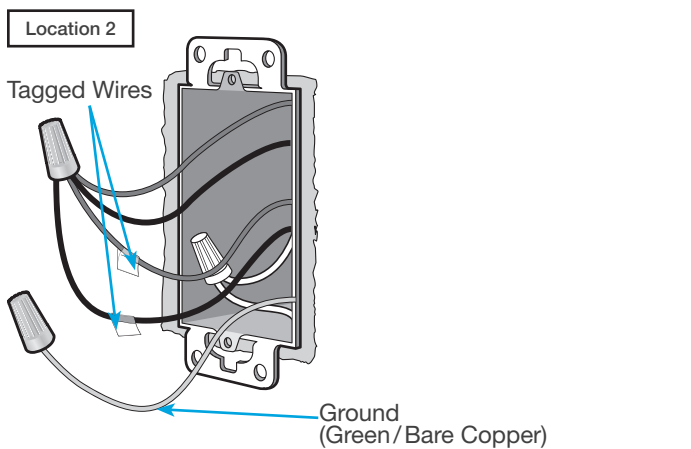

**14** Attach the wallplate bracket and Pico® remote control

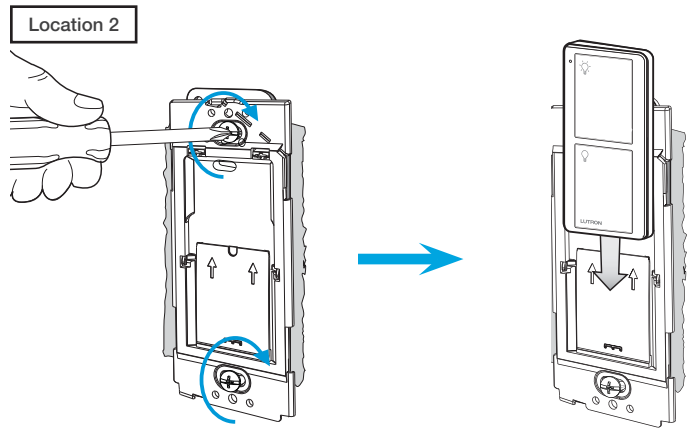

**15** Attach the wallplate

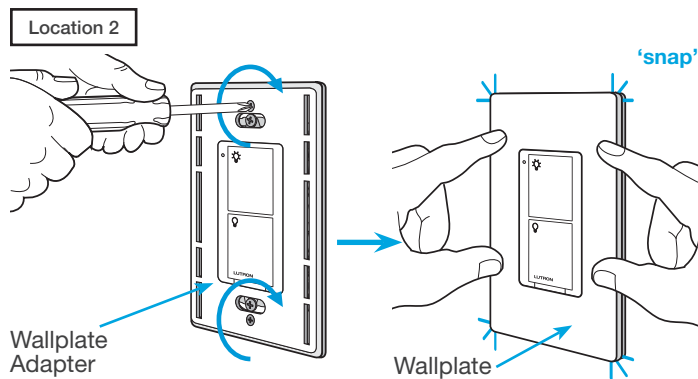

**16** Remove existing switch from wall at Location 3

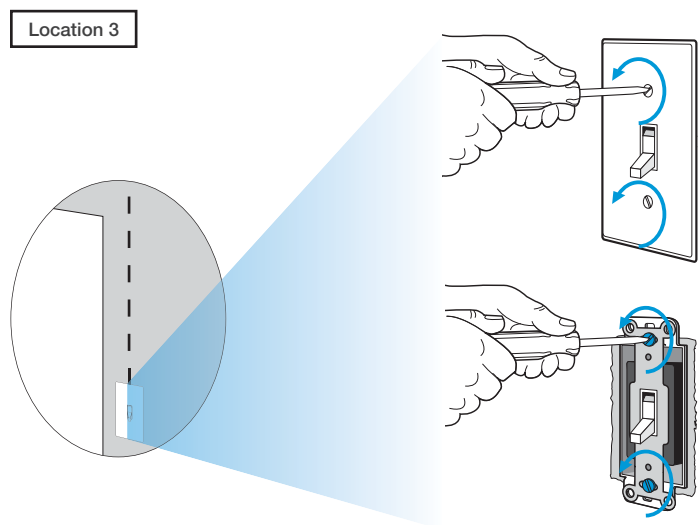

**17** Tag and disconnect wires from the existing switch

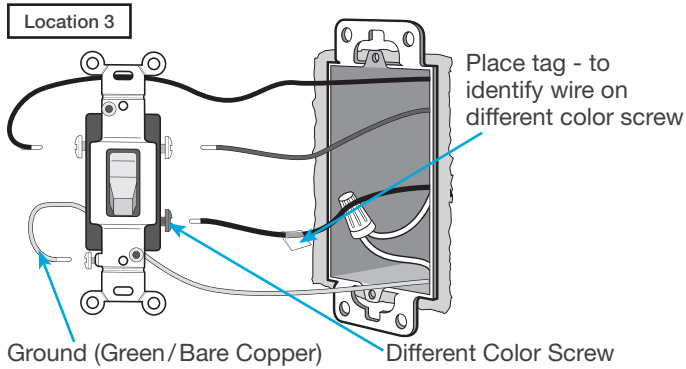

**18** Connect the wires

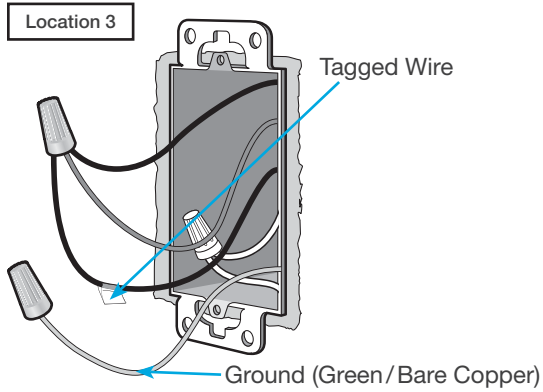

**19** Attach the wallplate bracket and Pico® remote control

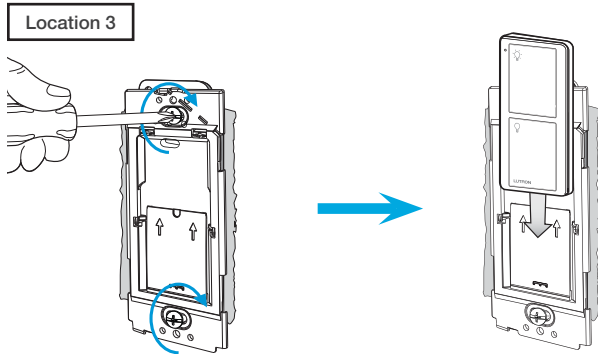

**20** Attach the wallplate

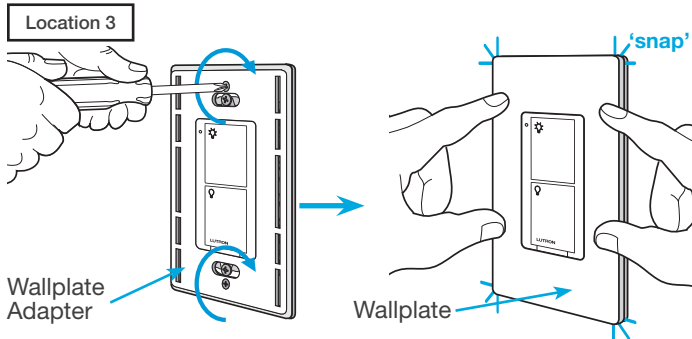

**21** Turn power on at circuit breaker

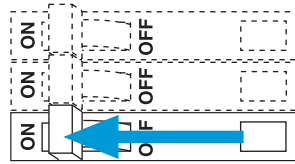

Pairing the switch and Pico® remote controls

**22** Press and hold "Off" button on dimmer

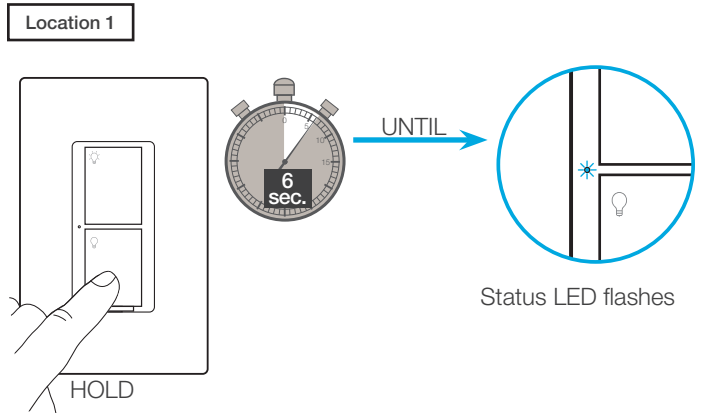

**23** Press and hold "Off" button on remote control

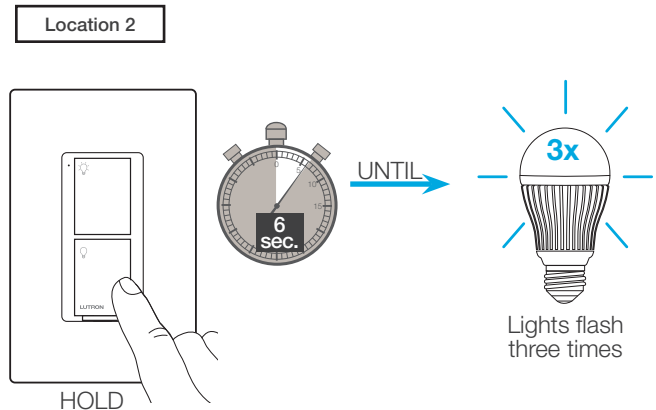

**24** Repeat for remote control at Location 3

Repeat steps 22 and 23 to pair remote control at Location 3.

Schematic Diagram

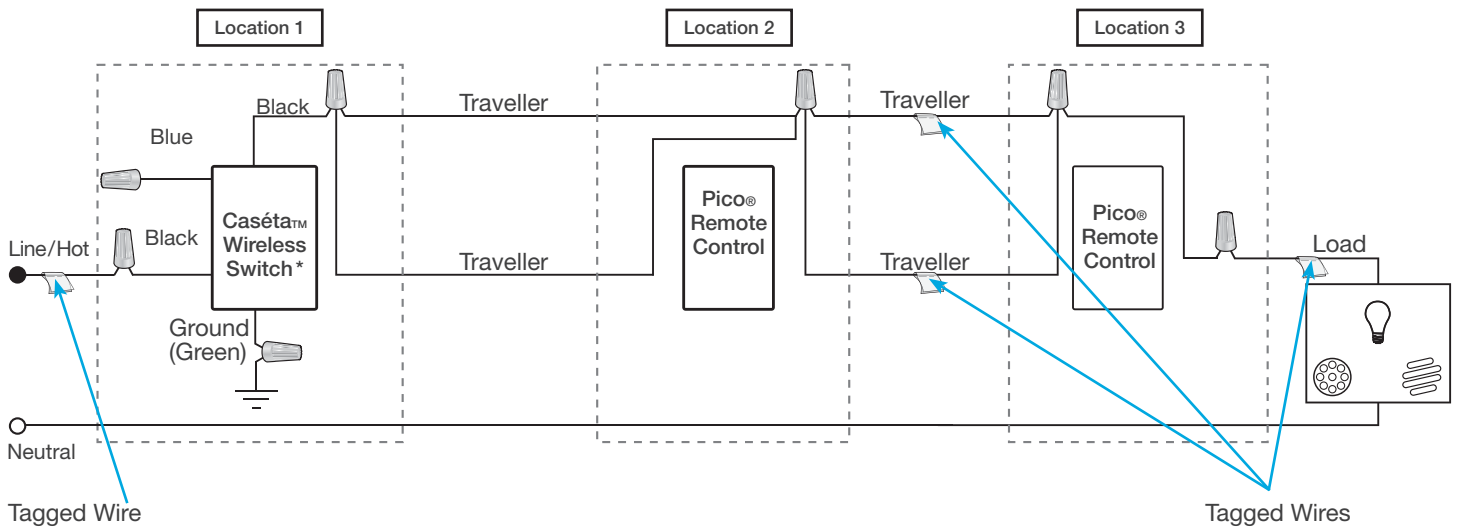

\* It is recommended to install switch in either Location 1 or 3.

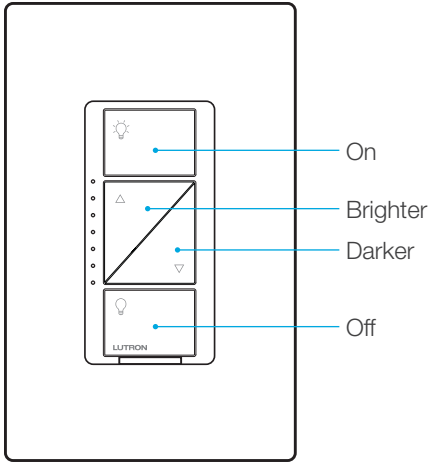

In-wall dimmer

Adjusting Low-End Trim -  
To optimize performance of CFL/LED lamps

**1 Enter**

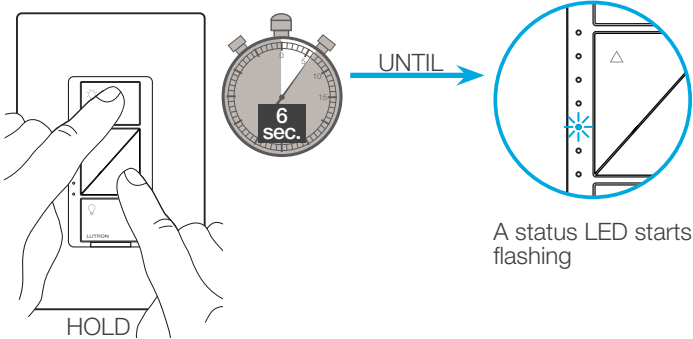

**2 Adjust**

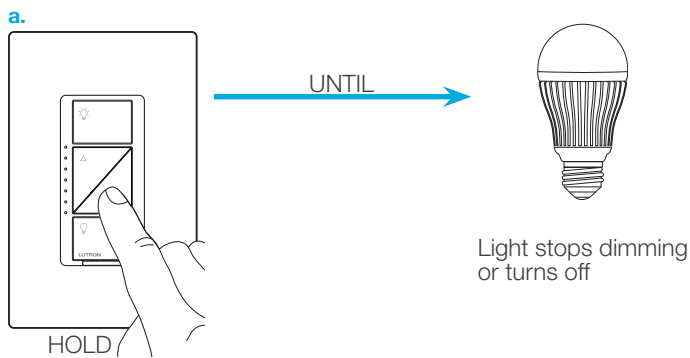

**2 Adjust (continued)**

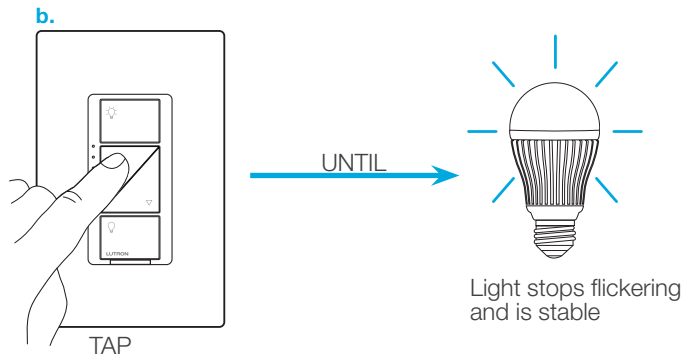

**3 Save**

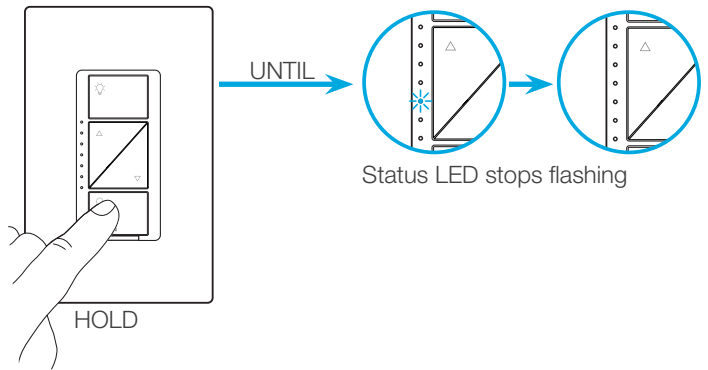

**4 Verify**

- a.
- b.
- c.
- a. Tap "Off" one time. Light will turn off.
  - b. Tap "Brighter" one time. Light will turn on.
  - c. If light is still off or is flickering, repeat steps 1-4.

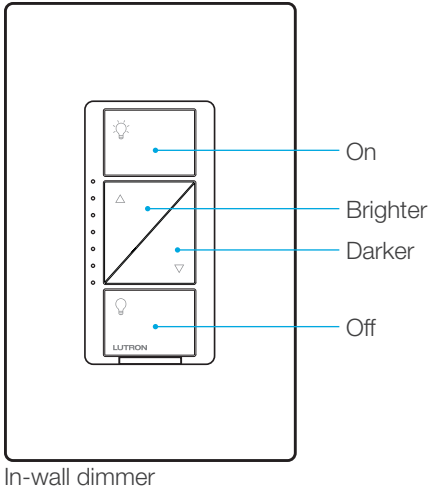

**2 Adjust (continued)**

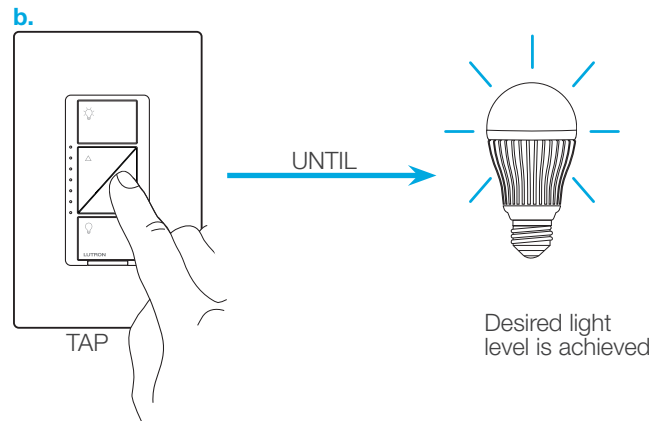

Adjusting High-End Trim -  
To optimize performance of CFL/LED lamps

**1 Enter**

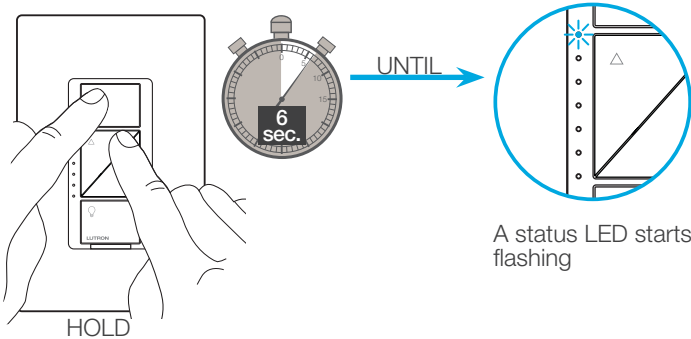

**3 Save**

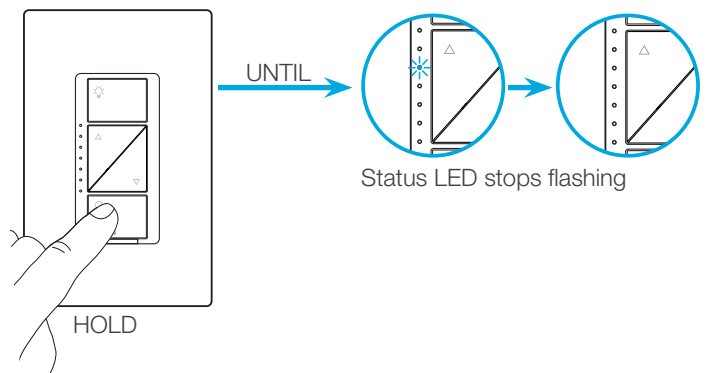

**2 Adjust**

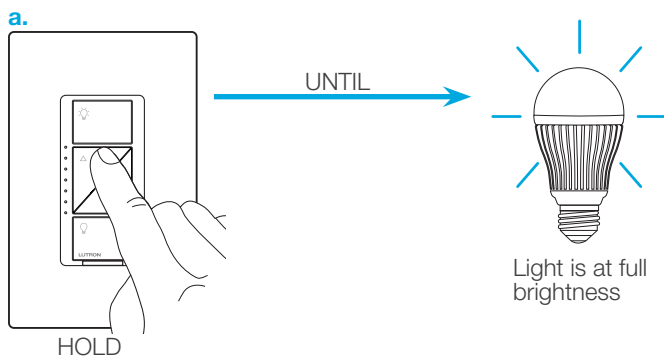



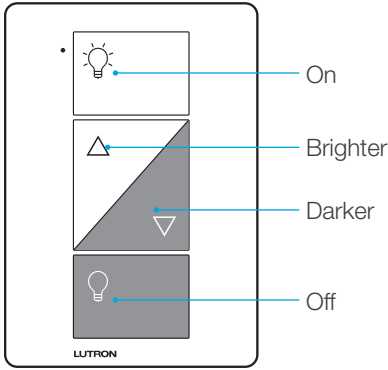

Plug-in lamp dimmer

### Adjusting Low-End Trim - To optimize performance of CFL/LED lamps

#### 1 Enter

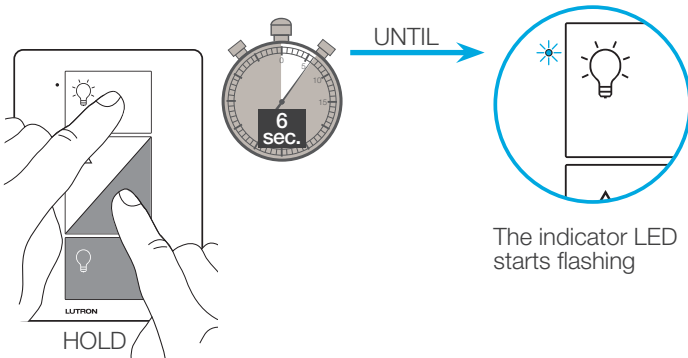

The indicator LED starts flashing

#### 2 Adjust

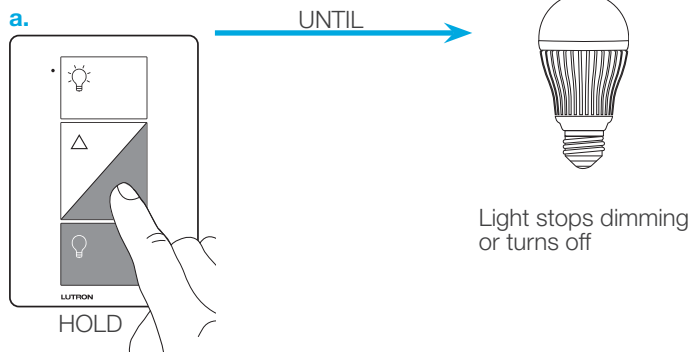

Light stops dimming or turns off

#### 2 Adjust (continued)

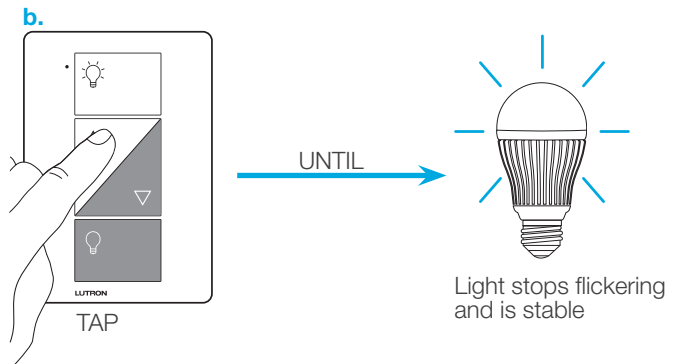

Light stops flickering and is stable

#### 3 Save

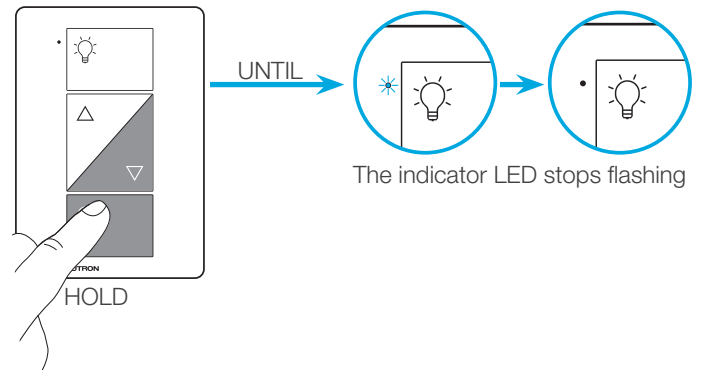

The indicator LED stops flashing

#### 4 Verify

- Tap "Off" one time. Light will turn off.
- Tap "Brighter" one time. Light will turn on.
- If light is still off or is flickering, repeat steps 1-4.

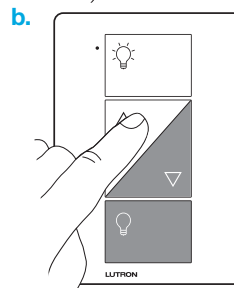

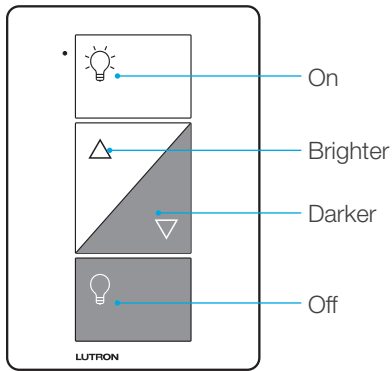

Plug-in lamp dimmer

### 2 Adjust (continued)

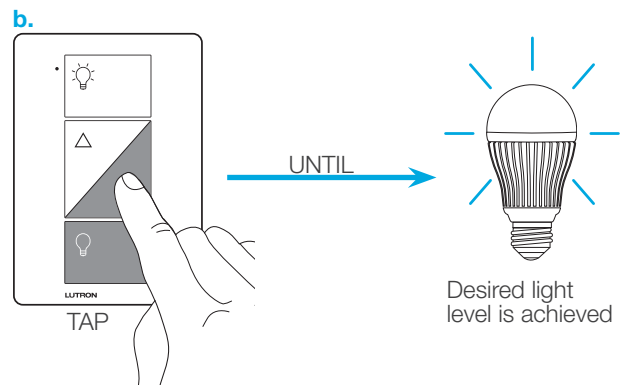

### 3 Save

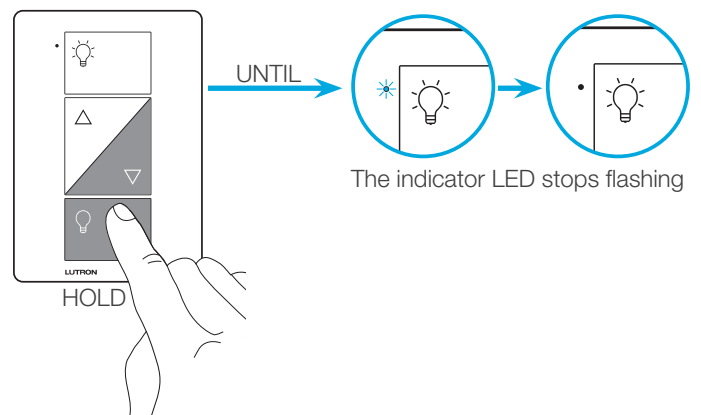

### Adjusting High-End Trim - To optimize performance of CFL/LED lamps

#### 1 Enter

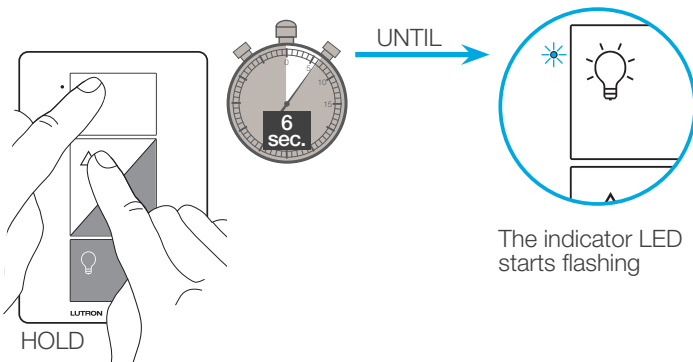

#### 2 Adjust

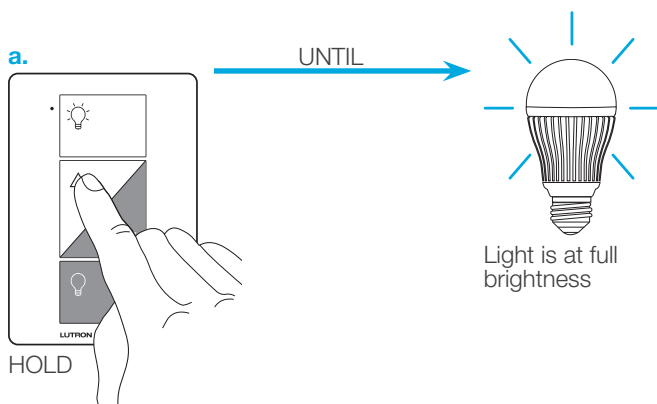

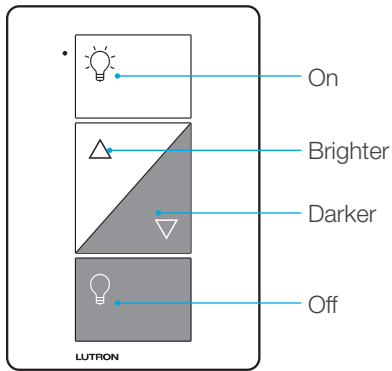

Plug-in lamp dimmer

### 1 Press and Hold "On" and "Off" buttons

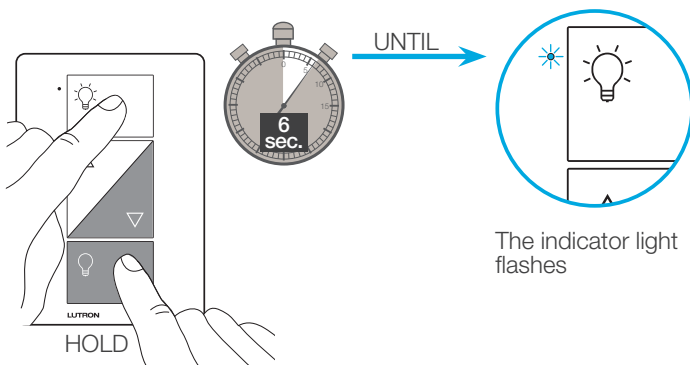

### 2 Verify

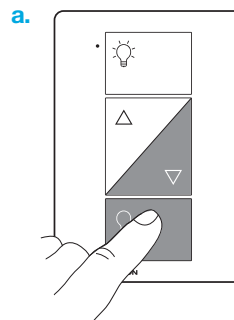

a. Tap "Off" one time. Light will turn off.

b. Tap "On" one time. Light will turn on.  
– The "Brighter" and "Darker" buttons will be disabled and do nothing.

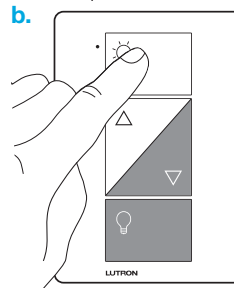

**NOTE:** Only use lighting loads on your plug-in lamp dimmer, even when operating in switch mode.

### 3 To change back to dimmer mode repeat step 1

**1** Tap the "On" button quickly three times, holding on the last press

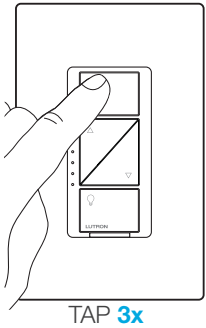

OR

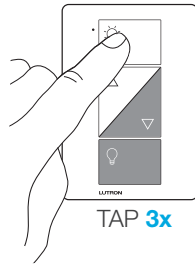

**2** Continue to hold the "On" button until the light begins to flash quickly

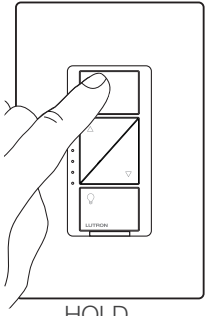

OR

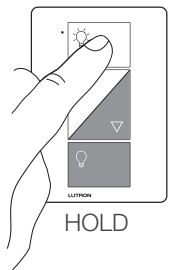

UNTIL →

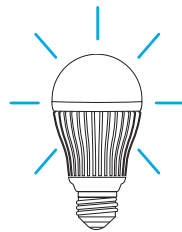

Light starts flashing quickly

**3** Release the button, then immediately tap the button three more times

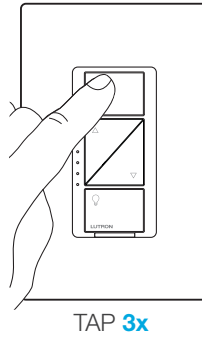

OR

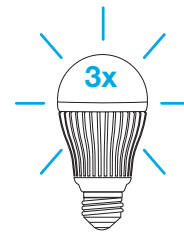
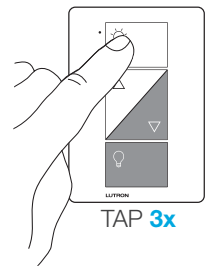

Light will flash slowly three times, then turn off

**4** All paired Pico® remote controls are removed and all settings are returned to factory default

– After the dimmer resets, the light will turn on to the full on state.

**NOTE:** This procedure also resets the high-end and low-end trim settings.

**1** Tap the "On" button quickly three times, holding on the last press

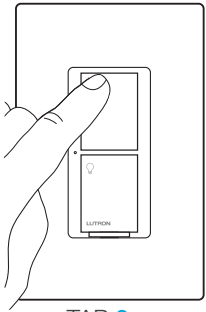

TAP 3x

**2** Continue to hold the "On" button until the Status LED begins to flash slowly

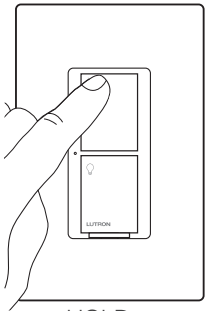

HOLD



UNTIL →

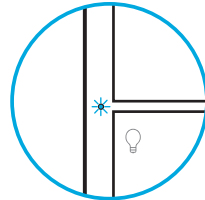

Status LED flashes slowly

**3** Release the button, then immediately tap the button three more times

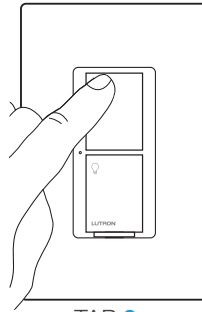

TAP 3x

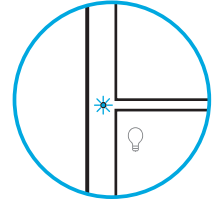

Status LED flashes quickly

AND

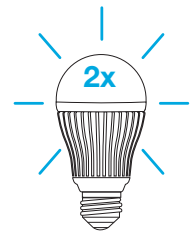

Light will flash slowly two times

**4** All paired Pico® remote controls are removed and all settings are returned to factory default

– After the device resets, the light will turn on to the full on state.

**NOTE:** This procedure will remove all paired Pico® remote controls and favorite button programming. Upper and lower limits are retained.

**1** Tap the shade button quickly three times, holding on the last press.

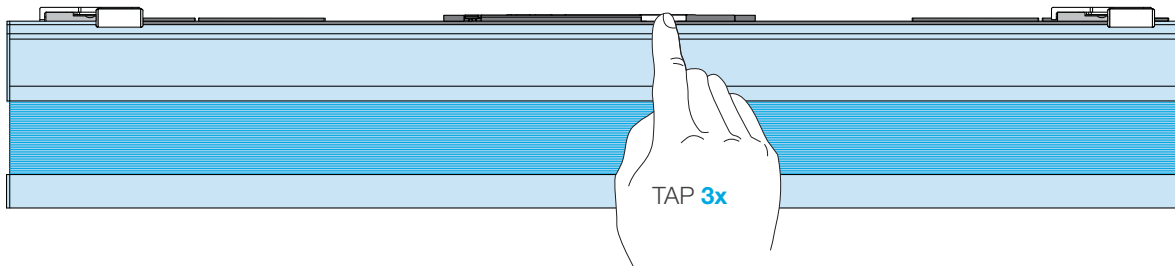

**2** Continue to hold the shade button until the shade button LED flashes green.

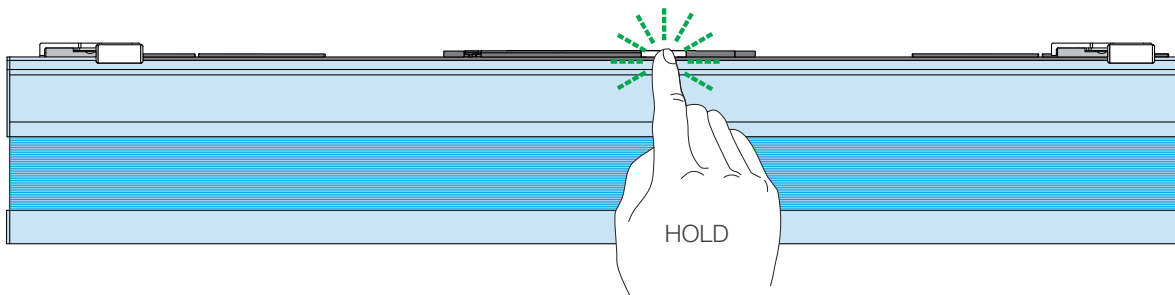

**3** Release the button, then immediately tap the button three more times.

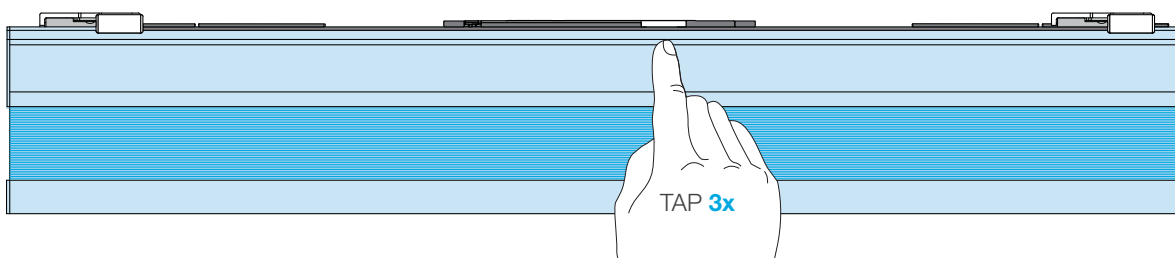

**NOTE:** The shade button LED will flash GREEN-then-RED three times, signaling the successful completion of the procedure.

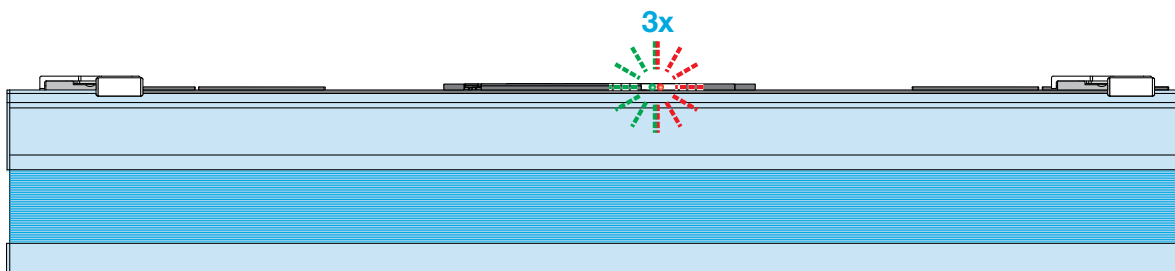

Roller Shades with a Single-Button (Battery-Powered and Plug-In)

**NOTE:** This procedure will remove all paired Pico® remote controls and favorite button programming. Upper and lower limits are retained.

**1** Tap the shade button quickly three times, holding on the last press.

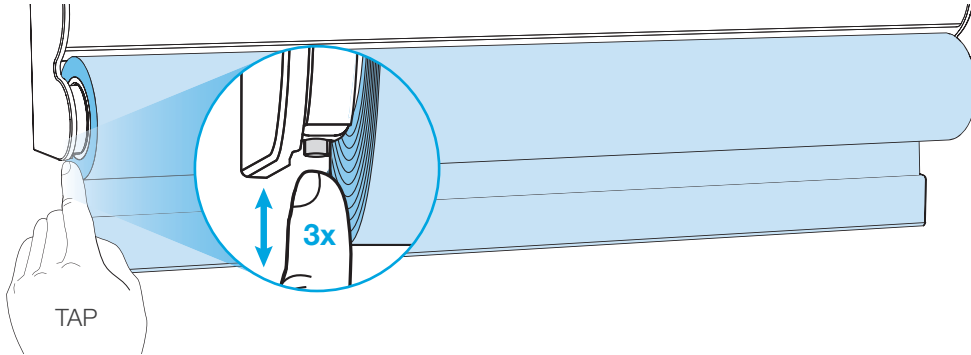

**2** Continue to hold the shade button until the shade button LED flashes green.

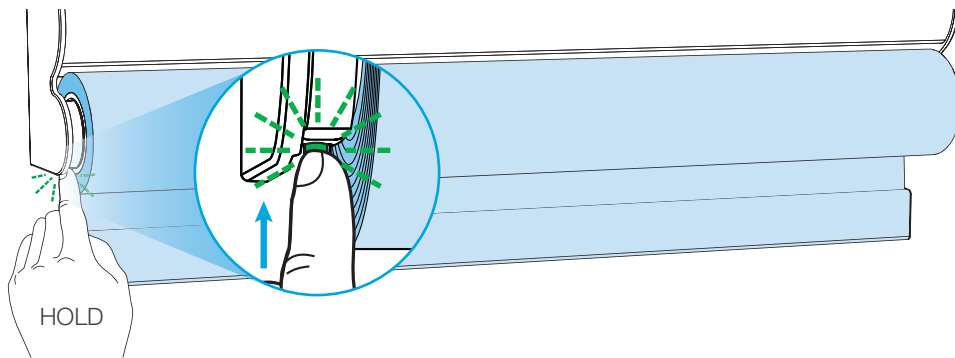

**3** Release the button, then immediately tap the button three more times.

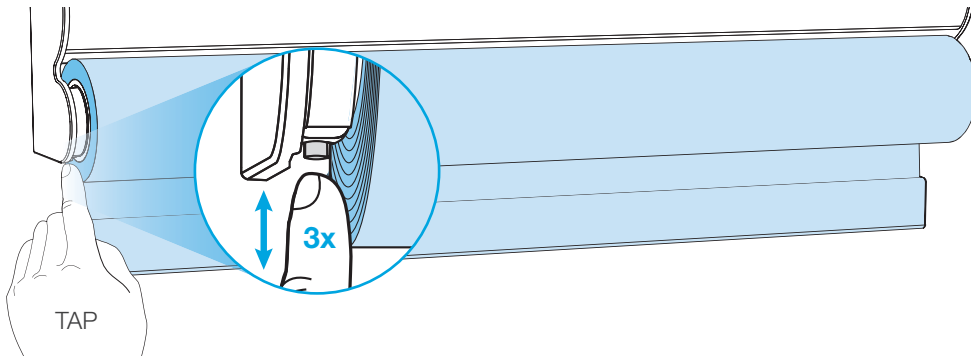

**NOTE:** The shade button LED will flash GREEN-then-RED three times, signaling the successful completion of the procedure.

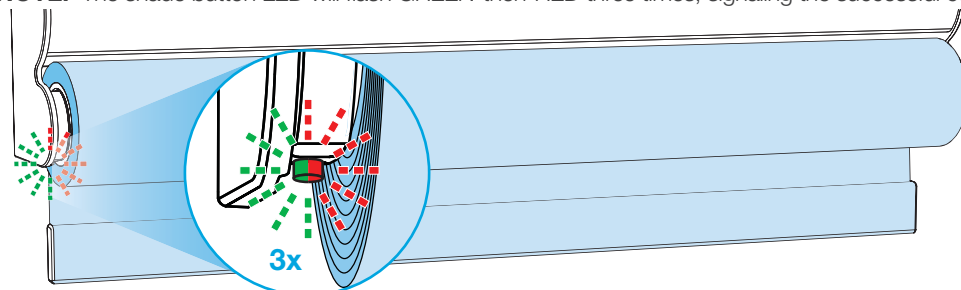

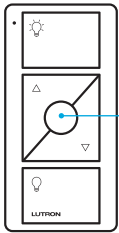

Favorite

You can use the round “Favorite” button on a Pico® remote control to recall a favorite light level. We’ve set it to 50%, but you can change it to any level you like.

### 1 Set desired light level on a dimmer that has already been paired with a remote control

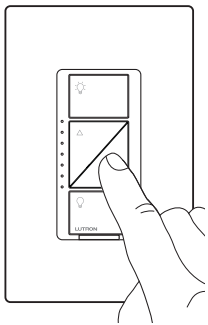

or

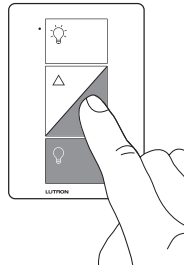

### 2 Save favorite light level

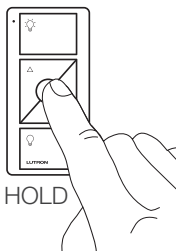

HOLD



UNTIL

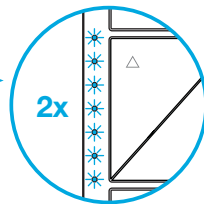

2x

or

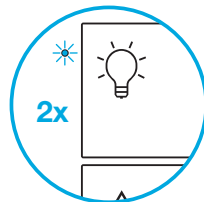

2x

Dimmer LED(s)  
flash(es) two times

### 3 Verify

a.

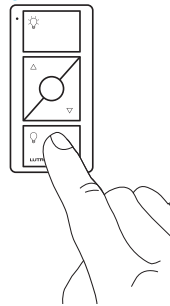

a. Tap "Off" button one time on remote control. Light will turn off.

b. Tap "Favorite" button one time on remote control. Light will turn on to the newly saved level.

b.

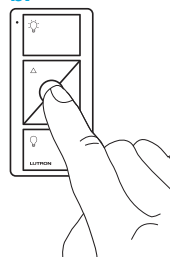



### 1 Identify load type



LED



CFL



Fluorescent



ELV

The LUT-MLC load adapter is provided to help ensure proper operation of the switch with LED, CFL, fluorescent, and ELV lighting loads. When controlling one of these load types, a LUT-MLC may be required, especially at lower wattages. If the status LED on the switch is flashing or a solid red color, a LUT-MLC must be installed. It is recommended to install a LUT-MLC with these load types regardless of wattage to guarantee best performance.

### 2 Turn power off at circuit breaker

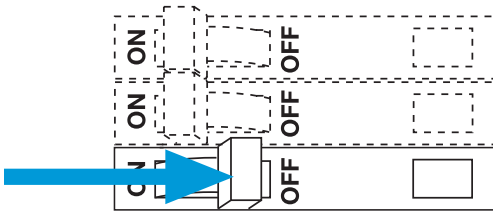

**WARNING! Shock Hazard.** May result in serious injury or death. Turn off power at circuit breaker before installing the unit.

### 3 Choose installation location

The LUT-MLC must be connected to the neutral and switched hot feed to the load. Install the LUT-MLC inside a load fixture or in a separate junction box within the circuit.

### 4 Installing the LUT-MLC in a load fixture or junction box

1. Connect one lead of the LUT-MLC to the neutral (white) wire.
2. Connect the other lead of the LUT-MLC to the switched hot (black) wire.

#### Junction Box

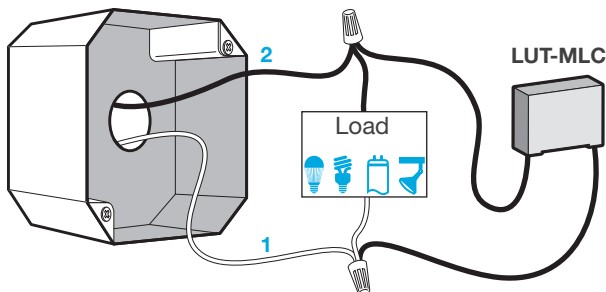

### 5 Turn power on at circuit breaker

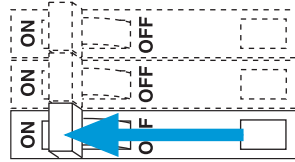

### 6 Verify performance

Verify that the LED on the switch is not flashing or solid red color and that the load stays off when the switch is turned off. In rare instances, some loads may still flicker or glow in the off state with the LUT-MLC installed. If this occurs, a different load may be required.

Symptoms	Probable cause and action
Light does not turn on or LEDs on the devices do not illuminate.	<ul style="list-style-type: none"> <li>• Light bulb(s) burned out.</li> <li>• Breaker is OFF or tripped.</li> <li>• Light not properly installed.</li> <li>• Wiring error.</li> </ul> <p><b>In-wall dimmer or switch:</b></p> <ul style="list-style-type: none"> <li>• FASS™ on the dimmer or switch is in the off position.</li> </ul> <p><b>Plug-in lamp dimmer:</b></p> <ul style="list-style-type: none"> <li>• Outlet is switched off.</li> <li>• Lamp is turned off.</li> <li>• Lamp is not plugged in.</li> </ul>
Light does not respond to Pico® remote control.	<ul style="list-style-type: none"> <li>• The dimmer or switch failed to pair with Pico® remote control.</li> <li>• The dimmer or switch is already at the light level the Pico® remote control is sending.</li> <li>• The Pico® remote control is outside the 30 ft (9 m) operating range.</li> <li>• The Pico® remote control battery is low.</li> <li>• The Pico® remote control battery is installed incorrectly.</li> </ul>
<ul style="list-style-type: none"> <li>• Bulbs turn off while being dimmed.</li> <li>• Bulbs turn on at high light level but do not turn on at a low light level.</li> <li>• Bulbs flicker or flash when dimmed to a low light level.</li> </ul>	<p><b>In-wall or plug-in lamp dimmer only:</b>          Verify bulbs are marked dimmable and visit <a href="http://www.casetawireless.com/lowend">www.casetawireless.com/lowend</a> for information on adjusting the dimmer for best bulb performance.</p>
<ul style="list-style-type: none"> <li>• LED on in-wall switch is flashing or solid red color.</li> <li>• Light stays on when the in-wall switch is turned off.</li> </ul>	<p><b>In-wall switch only:</b>          Proper bulb operation requires LUT-MLC installation. See <b>Page 33</b>.</p>

Go to [www.casetawireless.com/support](http://www.casetawireless.com/support) for additional troubleshooting suggestions.

Lutron, Claro and Pico are registered trademarks and FASS and Caséta are trademarks of Lutron Electronics Co., Inc.

## Lutron Contact Numbers

### WORLD HEADQUARTERS USA

Lutron Electronics Co., Inc.  
 7200 Suter Road  
 Coopersburg, PA 18036-1299  
 TEL: +1.610.282.3800  
 FAX: +1.610.282.1243  
 Toll-Free: 1.888.LUTRON1  
 Technical Support: 1.800.523.9466  
 intsales@lutron.com

### North & South America Technical Hotlines

**USA, Canada, Caribbean:**  
 1.800.523.9466  
**Mexico:**  
 +1.888.235.2910  
**Central/South America:**  
 +1.610.282.6701