

Autocirc® Instant Hot Water Pump Model: ACT E10

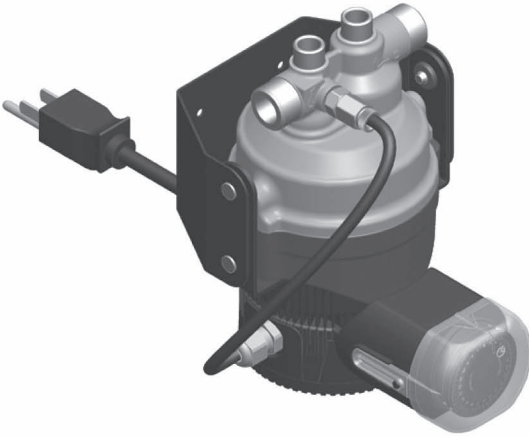

Please read this manual carefully before attempting to install, operate or maintain the product described. Failure to comply with the information provided in this manual could result in personal injury and/or property damage. Retain this manual for future reference.

INSTALLER: PLEASE LEAVE THIS MANUAL FOR THE OWNER'S USE.

How the Autocirc Pump System Works

The Autocirc® pump is installed under the sink farthest from the water heater, where hot water takes longest to arrive.

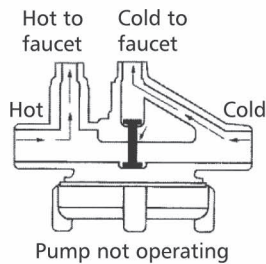
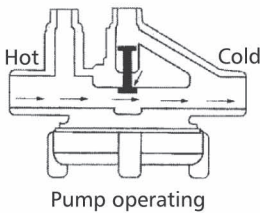

Model with fixed thermostat -

- A built-in temperature sensor automatically turns the pump ON when the water temperature in the hot water supply line cools down to 89.6°F (32°C). The pump then moves the cool water in the hot water supply line into the cold water supply line.
- Autocirc Pump turns OFF automatically when water temperature reaches 95°F (35°C), ensuring instant availability of warm water with hot water only seconds behind.
- When the pump is OFF, a built-in auto closure device (check valve) prevents hot and cold water mixing.
- Hot water will also be instantly available at all other fixtures between the water heater and the sink under which the Autocirc pump is installed.

The Autocirc

Pump System - Typical Schematic Diagram

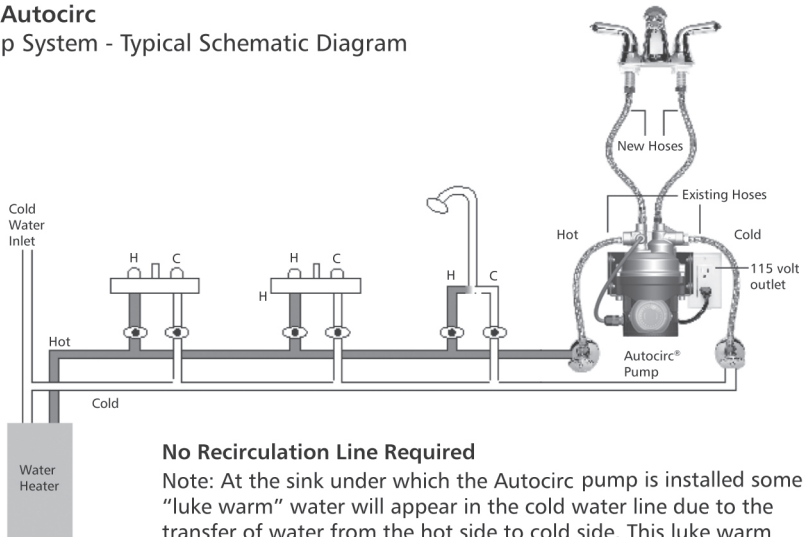

No Recirculation Line Required

Note: At the sink under which the Autocirc pump is installed some "luke warm" water will appear in the cold water line due to the transfer of water from the hot side to cold side. This luke warm water will, however, disappear in a short time (4-5 seconds) once the cold faucet/taps is opened.

Autocirc® Technical Data

Motor:	115 Volt, 1 Phase, 60Hz 60 Watts
Unit Weight:	5.5 lbs (2.35kg)
Overall Dimensions:	7" height (17.8cm) 6" width (15.2cm)



Australia

This pump must be installed in accordance with AS3500.

U.L. Caution

This pump has been tested using water only. Its suitability for use with liquids other than water is the end user's responsibility.

Preparation for Installation:

Assemble the parts and tools required:

1. Open and inspect Autocirc pump package.
2. Autocirc pump package includes the pump with a built-in timer, a 6ft. cord, and wall mounting bracket.
3. Two stainless steel flexible hoses (1/2" x 3/8") - length as required. (sold separately)
4. Adjustable wrench and screwdriver.
5. Select the sink under which the Autocirc pump is to be located (the sink where hot water takes longest to arrive).

Installation

Step 1

If not already available, install a 115 Volt/ 60Hz outlet within six (6) feet of the installation site (the faucet/tap farthest from the water heater), as the Autocirc is supplied with a 6 ft. long, grounded cord. The Autocirc pump requires only 14 watts and 0.3 amps of power (see Fig. 1).

Step 2

Autocirc pump and mounting bracket come preassembled. Remove mounting bracket from Autocirc by carefully sliding the mounting bracket off the (4) supporting pins on the Autocirc pump body. Fasten the mounting to the wall under the sink using the wall bracket provided in the Autocirc kit. Mount Autocirc pump into position by aligning and securing mounting bracket to the (4) support pins. Be sure the pump timer is turned toward the front and is accessible for setting and changing the time (see Fig. 2). The pump must be installed only in a vertical position as shown.



CAUTION: Do Not fasten pump to a thin wood panel wall as this might create a vibration noise when the pump is operating.

Step 3

Close the under sink hot and cold water riser shut-off valves and open the hot and cold water faucets/taps to relieve the water pressure. Close the water faucets/taps after pressure has bled from the lines.

Note: in some older homes, the riser shut-off valves may be difficult to shut off completely. If this is the case turn the water off at the main water inlet valve to the house.



Figure 1

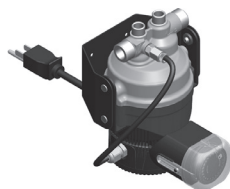

Figure 2



Figure 3

Remove the existing flexible line connection to the hot and cold water faucet/tap threaded nipples (see Fig. 3). (**TIP: Mark the hot and cold water flexible lines to easily identify them.**)

Note: If necessary, replace the existing flexible hoses with new stainless steel braided flexible hoses in the lengths required.

Step 4

Screw on the two existing 1/2" hose connections to the corresponding hot and cold sides of the pump housing (see Fig. 4). Be sure not to "kink" these existing hose lines during bending which may prevent adequate flow and/or cause the valves to break.



Figure 4

Note: It is recommended that the rubber washers in the hose connections be inspected to ensure they are in reusable condition. If not, they should be replaced.

Step 5

Screw on the 3/8" end of the purchased flexible hoses to the 3/8" connections on the pump housing. Screw on the 1/2" end of these same two hoses to the underside of the hot and cold water faucets/taps making sure to match the hot and cold sides marked on the pump housing with the corresponding faucet/tap. Be sure the hot side connection hose is attached to the hot water faucet/tap and the cold water side connection is attached to the cold water faucet/tap. Be sure the hoses used are long enough to allow the pump to be positioned as originally planned. (see Fig. 5)



Figure 5

Step 6

Be sure the screw ring attaching the motor to the pump housing is securely hand tightened. Do not over tighten the screw ring. Open the faucet/tap hot and cold riser shut off valves to insure there are no water leaks at any connections.



CAUTION: Fasten screw ring until tight to prevent leakage.

Step 7

Plug the pump cord into the wall outlet and start up the pump system (see next page).

Note: The above installation method applies to most situations where faucets/taps are connected to the hot and cold water supply lines with braided flexible hose/shut off valve arrangements. If the under sink arrangement is different (i.e. the risers are hard copper or plastic), then other parts may be required for the installation.

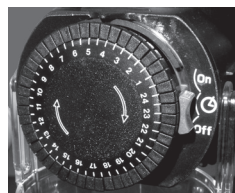



Figure 6

Autocirc Start Up Procedures Timer Controlled Operation

If timer controlled operation is desired, the timer may be programmed to allow the Autocirc to operate during the hours desired (i.e. "ON" from 7:00 a.m. to 9:00 p.m. and "OFF" from 9:00 p.m. to 7:00 a.m.) as follows:

- Open timer cover and rotate the dial clockwise until the correct time is aligned with the pointer at the top (12 o'clock position) of the dial.
- Automatic Operation: PULL the tabs Upward on timer for the desired operating period of time. Example: If the desired operating time is 7:00 a.m. to 9:00 a.m., all tabs should be Pulled out between 7 and 9. NOTE: The timer may be set for multiple operating periods of time.
- Slide the switch bar to  "On".

The timer mode will provide the most cost effective method of operation and can be programmed to run only during the time periods when hot water is most frequently required. Even during controlled timer operation, the Autocirc will only turn on when the built-in thermostat senses that additional hot water is required at the point of installation.

Thermostat Operation Mode

To operate the Autocirc "thermostatically" without the timer, slide the switch to the "ON" position. In the "ON" position the pump runs "automatically", whenever the built-in thermostat senses the requirement for hot water. In the "OFF" position the pump does not operate at any time.

In either the "ON" or "OFF" position, the timer dial continues to rotate through the 24 hour sequence keeping accurate time. When timer controlled operation is resumed, the Autocirc will operate during the previously programmed time sequence(s).

Note: The Autocirc will most likely start running immediately and turn off after a few minutes once hot water reaches the faucet. It will then continue cycling "ON" and "OFF" as required during the programmed sequence of operation. Do not be concerned if the pump does not begin running immediately after the pump is plugged in. This just means that there is already hot water at the hot water faucet and the pump will turn on "automatically" when the hot water line cools down.

Maintenance and Trouble Shooting

The pump does not turn on

- Ensure the timer slide switch is set to the "ON" position or the "⏻" position, that the timer clock is programmed to allow operation; and that there is power to the outlet.
- If the pump is installed under a kitchen sink, make sure the outlet is not controlled by a wall switch (i.e., garbage disposal).

The pump is noisy when on

- Turn off the Autocirc pump. Turn on the hot and cold faucets/taps to be sure all air is purged from the system.
- If the noise continues, unplug the pump and turn off the faucet/taps shut-off valves. Remove the pump from the wall bracket, loosen the screw ring to separate motor from the pump housing and check for any foreign matter in the rotor cavity. Also ensure the rotor is properly set on the motor bearing by pushing down on the rotor.
- If a noise occurs when the pump turns off it is likely to be "water hammer" that results from the closure of the built-in valve. In this situation, water hammer arresters may be installed on the hot and cold lines.

Hot water is not instantly available at all my faucets/taps

- Instant hot water will be available at all the hot water faucets/taps on the main plumbing line between the water heater and the faucet/taps under which the Autocirc system is installed. Hot water faucets/taps that are "branched" off this main hot water supply line will take longer for the hot water to arrive, however, usually faster than before installing the Autocirc.

I am away from my home for extended periods of time (2 weeks or more) • You may choose to turn the system off (slide the timer switch to the "OFF" position) as there is no need to maintain hot water in the supply line when no one is home to enjoy this convenience. When returning home, prior to turning on the system, we recommend that you turn on the hot and cold faucets/taps at the sink where the Autocirc system is installed until all air is purged from the dormant system and the water flows smoothly from the faucets/taps. Then slide the timer switch back to either the "ON" or "⏻" position.

Warranty

The Autocirc is warranted against defects in materials and workmanship for twenty-four (24) months from the date of manufacture (see the manufacturing date label on the pump) or twelve (12) months from the date of user purchase, with proof of purchase, whichever is sooner. In order to receive warranty considerations, the product must be returned prepaid to the company from which it was originally purchased. If the Autocirc is found defective within standard warranty conditions, it will be replaced or appropriate purchase credit will be issued.

Any consequential damages resulting from an Autocirc defect or malfunction are not covered by the Laing warranty. Any ancillary item(s) included with your Autocirc purchase, such as a flexible hose(s), is specifically excluded from the Laing warranty.

There shall be no other warranty or obligation, expressed or implied, oral or statutory. Laing, its agents, or employees shall in no event be liable for injury to any person, or for any claim for damage, however arising.

Laing shall not be liable for any incidental or consequential damages for breach of any express or implied warranty, breach of contract, negligence, strict liability, or any other legal theory related to this product. All consequential expenses including loss of use, damages, or contingent liabilities arising out of any alleged deficiencies of the Autocirc or any ancillary item packaged with the Autocirc are specifically excluded from this warranty.

This warranty is the sole and exclusive remedy for defects in materials and workmanship. All implied warranties of fitness and merchantability are hereby expressly excluded. There are no warranties that extend beyond the description on the face hereof.

Safety Requirements

Mechanical Safety



WARNING: - Excessive System Pressure Hazard - The maximum working pressure of the pump is listed on the nameplate - **Do Not Exceed This Pressure**. Failure to follow these instructions could result in serious personal injury, death and/or property damage.



WARNING: - Excessive Pressure Hazard Volumetric Expansion - The heating of water and other fluids causes volumetric expansion. The associated forces may cause failure of system components and the release of high temperature fluids. This can be prevented by installing properly sized and located compression tanks and pressure relief valves. Failure to follow these instructions could result in serious personal injury, death and/or property damage.

Thermal Safety



WARNING: - Extreme Temperature Hazard - If the pump, motor or piping are operating at extremely high or low temperature, guarding or insulation is required. Failure to follow these instructions could result in serious personal injury, death and/or property damage.

Electrical Safety



WARNING: - Electrical Shock Hazard - Electrical connections are to be made by a qualified electrician in accordance with all applicable codes, ordinances and good practices. Failure to follow these instructions could result in serious personal injury, death and/or property damage.



WARNING: - Electrical Grounding Hazard - Adequate electrical grounding is required for the safe operation of Laing pumps. Ground the pump back to the service using a copper conductor at least the size of the circuit connectors supplying the pump. Connect the ground wire to the ground terminal in the wiring compartment. Failure to follow these instructions could result in serious personal injury, death and/or property damage.



WARNING: - Risk of Electric Shock - If this pump is supplied with a grounding conductor and grounding-type attachment plug, to reduce the risk of electric shock, be certain that it is connected only to a properly grounded, grounding-type receptacle.



WARNING: - Risk of Electric Shock - Do not install this pump in swimming pool or marine areas. Failure to follow these instructions could result in serious personal injury, death and/or property damage.

Removal of Pump From Existing System For Replacement



WARNING: - Electrical Shock Hazard - Disconnect and lockout the power before servicing. Failure to follow these instructions could result in serious personal injury, death and/or property damage.

1. Close the valves on the suction and discharge sides of the pump. (if no valves have been installed, it may be necessary to drain the system.)
2. Disconnect the electrical supply lines to the pump.



WARNING: - Hot Water Hazard - Before draining the system, allow water to cool to at least 100F, open the drain valve (take precautions against water damage) and leave the drain valve open until servicing is complete. Failure to follow these instructions could result in serious personal injury, death and/or property damage.



WARNING: - Electrical Shock Hazard - Be certain the electrical power is not present at the motor leads before continuing. Failure to follow these instructions could result in serious personal injury, death and/or property damage.



WARNING: - High Pressure Hazard - Pressure may be present in the pump body. This pressure can be relieved by loosening the flange bolts and shifting the pump assembly slightly to allow the pressurized water to escape. Failure to follow these instructions could result in serious personal injury and death.

xylem
Let's Solve Water

Xylem Inc.
3878 S. Willow, Suite 104
Fresno, CA 93725
Tel: (559) 265-4730 (800) 554-6853
Fax: (559) 265-4740 (800) 453-7523
www.xyleminc.com/brands/laingthermotech

Laing Thermotech is a trademark of Xylem Inc. or one of its subsidiaries.
© 2012 Xylem, Inc. 6-71-075-109A July 2012