











## A Century of Quality and Innovation

In 1885, the IRWIN® Auger Bit Company was formed. Over 125 years later, IRWIN is still the leading manufacturer of wood drilling bits and accessories. No matter what wood drilling project you face, IRWIN Tools makes a drill bit that performs the job better. Our mark of quality is stamped right on the shank of our full range of bits. Whether the job requires quick, clean holes or precise finish work, IRWIN has a bit for every application and every need.

The all new IRWIN® WeldTec™ pole auger is made stronger and lasts longer than any pole auger in the market. It features a welded high speed steel cutting edge that is sharper and larger than standard carbon steel pole augers, providing increased durability and faster drilling in dense, treated, or creosote-soaked wood. With a feed screw that is 50% larger\* and a 10% faster pitch\*, it's designed specifically for drilling deep holes in dense wood. The flutes are about two times wider\* for maximum chip removal – even in the deepest holes. Only IRWIN offers the superior performance and added durability of WeldTec.

Use the chart below to determine which bit is best for the job at hand.

Bit Style	Size Range	Typical Trades	Application Benefits
 <p>Tri-Flute Bit</p>	7/16" to 1-1/2" diameter	Carpentry, Electrical, Plumbing	Fast, clean holes with reduced "break out" when through-hole drilling. Full-screw tip requires less effort.
 <p>Spade Bit</p>	1/4" to 1-1/2" diameter 4-3/4" to 16" lengths	Carpentry, Electrical, Plumbing	Fast, clean holes with reduced "break out" for through-hole drilling or countersinking.
 <p>Solid Center Auger Bit</p>	1/4" to 1-1/2" diameter 7-1/2" length	Carpentry, Electrical, Plumbing	Self-feeding tip pulls bit into the work for repetitive cutting of fast clean holes with a clean exit hole. Single-spur cutting edge scribes the circumference of the hole for a smoother finish.
 <p>Hollow Center Auger Bit</p>	3/8" to 2" diameter 7-1/2" to 29" lengths	Public Utilities, Electrical, Plumbing, Carpentry, Log Homes	Hollow center provides better chip removal for deeper holes in utility poles and logs.
 <p>Installer Bit</p>	1/4" to 3/4" diameter 12" to 30" lengths	Telecommunications, Cable/Internet, Security Systems	Wire hole near the end of the bit enables user to pull wire back through the hole after drilling.
 <p>Self-Feed Bit</p>	1" to 4-5/8" diameter	Plumbing, Electrical, General Contracting	Replaceable self-feeding tip pulls bit into the wood. Best for cutting larger holes with clean edges.
 <p>Forstner Bit</p>	1/4" to 2-1/8" diameter	Fine Woodworking, Cabinet Making	Precise cutting of smooth, flat-bottomed (blind) holes with clean, sharp edges.
 <p>Brad Point Bit</p>	1/8" to 1/2" diameter	Woodworking, Cabinet Making	Precise cutting of smooth through-holes with clean, sharp edges and reduced "break out."
 <p>Countersink Bit</p>	1/8" to 1/2" diameter	Woodworking, Cabinet Making	Perfect for variable-size countersink holes.
 <p>Plug Cutters</p>	1/8" to 1/2" diameter	Woodworking, Cabinet Making	Perfect for cutting dowels or plug holes.
 <p>Quick-Change Extensions</p>	1/4" available in 2", 6" and 12" length 3/8" available in 2", 5-1/2" and 12" length 7/16" available in 5-1/2", 12" and 18" length	Woodworking, Cabinet Making	Lock-n-Load® system for quick release and fast bit changes.

\* vs. standard pole augers

### SPEEDBOR MAX SELF-FEED BIT FEATURES

1. Three re-sharpenable cutting edges are hardened for extreme durability and long life in tough materials.\*
2. Replaceable screw-point tip pulls bit fast for clean, true holes.
3. 7/16" hex quick-change shank reduces slipping in standard chucks and is compatible with all 7/16" impact drills.

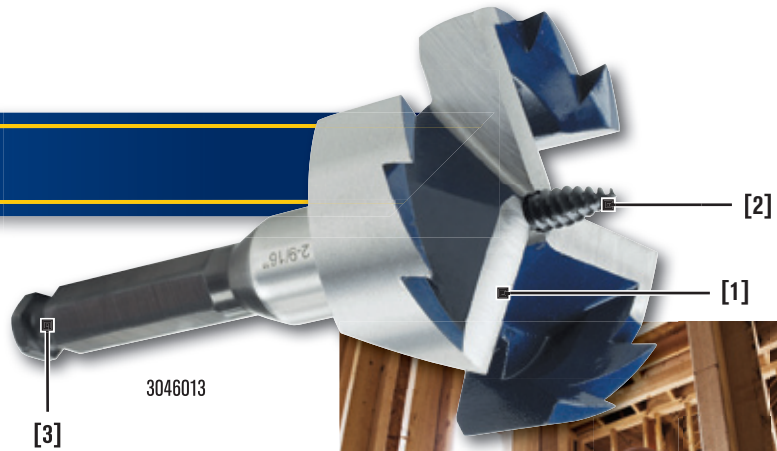

\* 2 cutting edges on sizes 3" and larger

### SPEEDBOR Max Self-Feed Wood Bits



3046010



4935655



3046002

Diameter	Shank Size	Overall Length	Item #
1"	7/16"	5"	3046004
1-1/8"	7/16"	5"	3046005
1-1/4"	7/16"	5"	3046006
1-3/8"	7/16"	5"	3046007
1-1/2"	7/16"	5"	3046008
1-3/4"	7/16"	5"	3046009
2"	7/16"	5"	3046010
2-1/8"	7/16"	5"	3046011
2-1/4"	7/16"	5"	3046012
2-9/16"	7/16"	5"	3046013
3"	7/16"	5"	3046014
3-5/8"	7/16"	5"	3046015
4-5/8"	7/16"	5"	3046016

#### Replacement Tips - Includes (5) Screw Tips, (5) Set Screws, and (1) Hex Key

Self-feed tips 1" - 1-3/8" bits	1792762
Self-feed tips 1-1/2" - 2-9/16" bits	1792763
Self-feed tips 3" - 4-5/8" bits	1792764

#### Lock-n-Load® Quick-Change Extensions

7/16" Quick-Change Bit Holder 5-1/2" OAL / 1-1/16" OAW	4935654
7/16" Quick-Change Bit Holder 12" OAL / 1-1/16" OAW	4935655
7/16" Quick-Change Bit Holder 18" OAL / 1-1/16" OAW	4935656

#### Manual Locking Hex Key Extensions

7/16" Manual Locking Hex Extensions 5-1/2" OAL / 1-1/16" OAW	3046001
7/16" Manual Locking Hex Extensions 12" OAL / 1-1/16" OAW	3046002
7/16" Manual Locking Hex Extensions 18" OAL / 1-1/16" OAW	3046003