

- INTEGRAL OPPOSED BLADE DAMPER
- AVAILABLE IN SIZES 6 X 6 THROUGH 14 X 14 IN 2 INCH INCREMENTS
- A STEEL PANEL FOR ALL SIZES AND PATTERNS FITS 24 X 24 INCH T-BAR CEILINGS SEE SD-2302
- FINISH: WHITE (W) ENAMEL

4 WAY CORE SHOWN

AIR VOLUME CONTROL LEVER

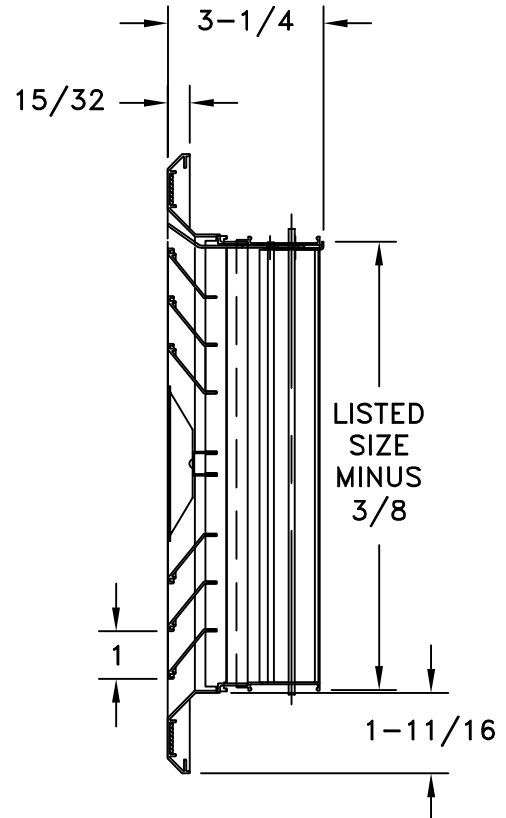
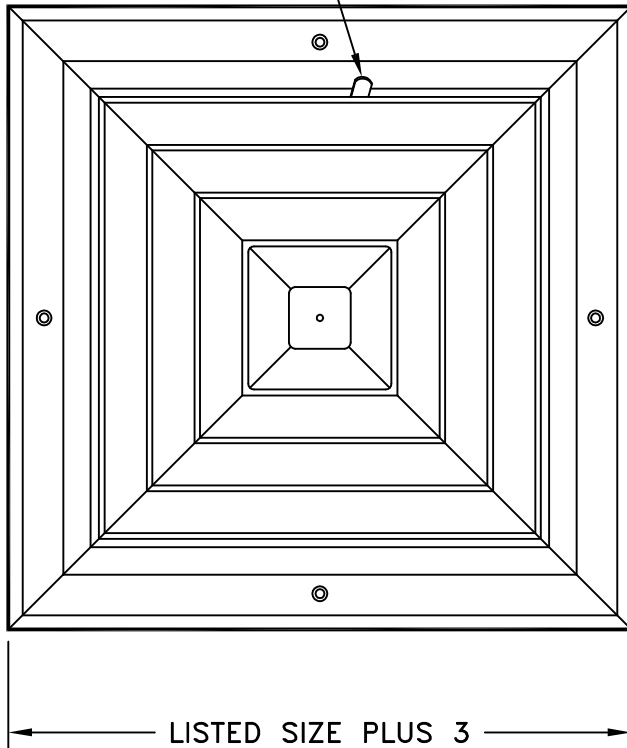

FLOW PATTERNS

1 WAY
A501-OB

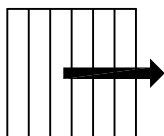

2 WAY
A502-OB

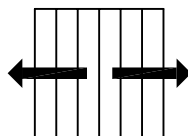

3 WAY
A503-OB

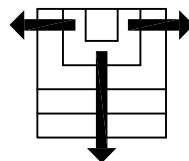

4 WAY
A504-OB

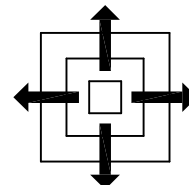

2 WAY
CORNER
A505-OB

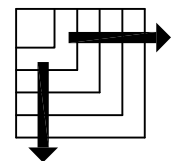

JOB NAME: _____
 LOCATION: _____
 ARCHITECT: _____
 ENGINEER: _____
 CONTRACTOR: _____

SUBMITTED BY: _____

DATE: 08/26/2013 SD-2301

A500-OB
 Aluminum Square Diffuser
 With Opposed Blade Damper