

COMMERCIAL · INDUSTRIAL · RESIDENTIAL

**Flash  
Shield**  
ENHANCED PROTECTION



## Design and Installation Guide



**Gastite**<sup>®</sup>  
The System is the Solution<sup>™</sup>

January 2013  
[www.gastite.com](http://www.gastite.com)





# Important Lightning Safety Warning

## LIGHTNING SAFETY WARNING

**1 PROPERLY BONDING** and grounding the Corrugated Stainless Steel Tubing (CSST) system may reduce the risk of damage and fire from a lightning strike. Lightning is a highly destructive force. Even a nearby lightning strike that does not strike a structure directly can cause systems in the structure to become electrically energized. Differences in potential between systems may cause the charge to arc between systems. Such arcing can cause damage to CSST, including holes. Bonding and grounding should reduce the risk of arcing and related damage. The building owner should confirm that a qualified contractor has properly bonded the CSST gas system to the grounding electrode system of the premises. Refer to Section 4.10 Electrical Bonding/ Grounding in the Gastite Design & Installation Guide for details on bonding & grounding CSST.

**2 ALL OWNERS** should consult a lightning safety consultant to determine whether installation of a lightning protection system would be required to achieve sufficient protection for all building components from lightning. Factors to consider include whether the area is prone to lightning. Areas with high lightning risk include but are not limited to: Alabama, Arkansas, Florida, Georgia, Illinois, Indiana, Iowa, Kentucky, Louisiana, Maryland, Michigan, Mississippi, Missouri, New Mexico, North Carolina, Ohio, Oklahoma, Pennsylvania, South Carolina, Tennessee, Texas, Virginia and West Virginia. One currently available source of information regarding areas more prone to lightning than others is the flash density map provided by the National Weather Service which can be found at [http://www.lightningsafety.noaa.gov/lightning\\_map.htm](http://www.lightningsafety.noaa.gov/lightning_map.htm). Lightning protection systems are beyond the scope of this manual and installation guidelines, but are covered by National Fire Protection Association, NFPA 780, the Standard for the Installation of Lightning Protection Systems, and other standards.

**3 THE OWNER** should confirm with the local gas supply utility company that a suitable dielectric union is installed at the service entry of the structure between underground metallic piping and the gas pipes going into the building as required by code.

**4 NATIONAL ELECTRIC CODE (NEC)**, Section 250.104b, states that "bonding all piping and metal air ducts within the premises will provide additional safety". Gastite recommends that all continuous metallic systems be bonded and grounded. The owner should confirm with an electrical or construction specialist that each continuous metallic system in a structure has been bonded and grounded by an electrical professional in accordance with local building codes. This should include, but is not limited to metallic chimney liners, metallic appliance vents, metallic ducting and piping, electrical cables, and structural steel.

**5 CARE SHOULD BE TAKEN** when installing any type of fuel gas piping (including CSST, iron, or copper) to maintain as much separation as reasonably possible from other electrically conductive systems in the building. Refer to sec. 4.3 Routing, in the Gastite D&I Guide for installation techniques. Consult local building codes as to required separations for CSST from such conductive systems including metallic chimney liners, metallic appliance vents, metallic ducting and piping, and electrical cables. See for instance the Indiana Residential Code, section 675 IAC 14-4.3-155.5 Section G2411.1; gas pipe bonding.

**6 LOCAL BUILDING CODES** are controlling, however, as a general practice, fuel gas piping, including CSST, should not be installed within a chase or enclosure that houses a metallic chimney liner or appliance vent that protrudes through the roof. In the event such an installation is necessary and conforms to local building codes, the metallic chimney liner or vent must be bonded and grounded by a qualified electrical professional, and a separation distance, as specifically permitted by the applicable local building code between the CSST and the metallic chimney liner or vent, is required. Physical contact between CSST and the metallic chimney liner and/or vent is prohibited. If this physical separation cannot be specifically identified in the local building code and achieved or any local building code requirements cannot be met along the entire length, then rerouting of the CSST is required unless such installation is specifically permitted by the local building inspector.



[www.gastite.com](http://www.gastite.com)

© 2013, Gastite Division, Titeflex Corporation  
GENERAL 1/20/13



**SECTION 1.0 INTRODUCTION**

1.1 General User Warnings..... 1

1.2 Limitations of the Guidelines ..... 4

1.3 Standards, Listings and Codes ..... 4

**SECTION 2.0 SYSTEM DESCRIPTIONS & COMPONENTS**

2.1 System Descriptions ..... 5

    2.1.1 *Gastite® System Description*..... 5

    2.1.2 *FlashShield™ System Description* ..... 6

2.2 Components ..... 7-8

    2.2.1 *Corrugated Stainless Steel Tubing*..... 8

    2.2.2 *Fittings*..... 9-12

    2.2.3 *Manifolds*..... 12

    2.2.4 *Modular Stub System* ..... 13

    2.2.5 *Mounting Hardware*..... 14

    2.2.6 *Pipe Support System* ..... 14

    2.2.7 *Strike Protection* ..... 15

    2.2.8 *Shut-Off Valves and Quick Connects* ..... 15

    2.2.9 *Gastite Accessories* ..... 16

    2.2.10 *Bonding Clamps* ..... 16

    2.2.11 *System Identification* ..... 16

    2.2.12 *Regulators*..... 17

**SECTION 3.0 SYSTEM CONFIGURATION**

3.1 Configuration..... 20

    3.1.1 *Introduction* ..... 20

    3.1.2 *System Requirements* ..... 20

    3.1.3 *Reference Data for Proper System Sizing*..... 20

    3.1.4 *Determining System Layout*..... 21-22

    3.1.5 *Allowable Pressure Drop* ..... 23

    3.1.6 *Sizing Methods* ..... 23-24

    3.1.7 *Modifying an Existing System* ..... 24

3.2 Sizing Procedures and Exercises ..... 24

    3.2.1 *Sizing Examples*..... 24

    3.2.2 *Example 1 - Series System – 6"WC*..... 25-26

    3.2.3 *Example 2 - Parallel System – 6"WC*..... 27-28

    3.2.4 *Example 3 - Parallel System – 12-14"WC*..... 29-30

    3.2.5 *Example 4 - Dual Pressure System – 2 PSI Trunk and 8"WC Appliance Runs* ..... 31-32

    3.2.6 *Example 5 - Multiple Manifold System* ..... 33-34

    3.2.7 *Example 6 - Series System – 7"WC - Hybrid* ..... 35-36

    3.2.8 *Example 7 - Parallel System – 7"WC – Hybrid*..... 37-38

    3.2.9 *Example 8 - Summation Method for Parallel System – 7"WC – Hybrid*..... 39-40

    3.2.10 *Example 9 - Summation Method for Series System – 6"WC*..... 41-43

    3.2.11 *Example 10 - Commercial Elevated Pressure Series System – 2PSI* ..... 44-45

    3.2.12 *Example 11 - Commercial Hybrid System – 7"WC*..... 46-48

**SECTION 4.0 INSTALLATION PRACTICES**

4.1 General Provisions..... 49

4.2 Field Fitting Assembly Procedure ..... 50

    4.2.1 *Gastite Field Fitting*..... 50-51

    4.2.2 *FlashShield Field Fitting Assembly*..... 52-54

4.3 Routing..... 55

    4.3.1 *Vertical Runs* ..... 55

    4.3.2 *Horizontal Runs* ..... 55

    4.3.3 *Installation Clearance Holes* ..... 55

    4.3.4 *Concealed Fittings*..... 56

    4.3.5 *Modifications to Existing Systems* ..... 56

    4.3.6 *Outdoor* ..... 57

4.3.7	<i>Fire Rated Constructions</i> .....	57
4.3.8	<i>Routing Through Masonry Material</i> .....	57
4.3.9	<i>Installation Within a Chase</i> .....	57
4.3.10	<i>Clearance From the Underside of a Roof Deck</i> .....	58
4.4	Strike Protection.....	58
4.4.1	<i>Strike Plates</i> .....	58-59
4.4.2	<i>Steel Conduit</i> .....	60
4.5	Meter .....	60
4.6	Appliance .....	61
4.6.1	<i>Moveable Appliance</i> .....	61
4.6.2	<i>Direct Connection – Non-Moveable Appliances</i> .....	62
4.6.3	<i>Gas Convenience Outlet</i> .....	62
4.6.4	<i>Special Applications</i> .....	63-66
4.7	Manifold .....	67
4.8	Pressure Regulator .....	68
4.8.1	<i>Introduction</i> .....	68
4.8.2	<i>Sizing Instructions</i> .....	68-69
4.8.3	<i>Installation</i> .....	70
4.8.4	<i>Performance</i> .....	71
4.8.5	<i>Regulator Outlet Pressure Adjustment</i> .....	71
4.8.6	<i>Over-Pressurization Protection</i> .....	71
4.9	Underground Installations.....	72
4.10	Electrical Bonding of Gastite®/FlashShield™ CSST .....	73
<b>SECTION 5.0 INSPECTION, REPAIR AND REPLACEMENT</b>		
5.1	Minimum Inspection Requirements.....	74
5.2	Installation Checklist Description .....	75
5.3	Repair of Damaged CSST .....	76
5.3.1	<i>Determine Damage</i> .....	76
5.3.2	<i>Method of Repair</i> .....	76
<b>SECTION 6.0 PRESSURE/LEAKAGE TESTING</b>		
6.1	General Guidelines for Pressure Testing.....	77
6.2	Elevated Pressure Systems.....	77
6.3	Appliance Connection Leakage Check Procedure .....	78
<b>SECTION 7.0 SIZING TABLES AND PRESSURE DROP CHARTS</b>		
7.1	CSST Capacity Tables - Natural Gas .....	79-82
7.2	CSST Capacity Tables - Natural Gas - Elevated Pressure .....	83-84
7.3	CSST Capacity Tables - Propane Gas .....	85-87
7.4	CSST Capacity Tables - Propane Gas - Elevated Pressure .....	87-88
7.5	Gastite® and FlashShield™ CSST Pressure Drop Tables .....	89-92
7.6	Iron Pipe Capacity Tables.....	93
7.7	Iron Pipe Pressure Drop Tables.....	94-97
7.8	Reference Data .....	98
<b>SECTION 8.0 DEFINITIONS .....99-100</b>		
<b>SECTION 9.0 DIMENSIONAL AND TECHNICAL REFERENCE DATA ..... 101</b>		
9.1	Gastite® Dimensional and Technical Reference Data.....	101
9.2	FlashShield™ Dimensional and Technical Reference Data.....	102-104
<b>SECTION 10.0 WARRANTY..... 105</b>		
<b>FREQUENTLY ASKED QUESTIONS ..... 106</b>		
<b>FLEXIBLE GAS PIPING TRAINING PROGRAM TEST</b>		



# SECTION 1.0 INTRODUCTION

## 1.1 General User Warnings

Please note that there are specific differences between Gastite and FlashShield™ throughout this Design and Installation Guide. Please take note of these differences as you read through the Guide.

The installation of Gastite® or FlashShield™ Flexible Gas Piping must be performed by a qualified installer who has successfully completed the Gastite®/FlashShield™ training program. The installer must meet all qualifications and requirements to install gas piping as required by the local administrative authority. Improper installation or operation of a Gastite® or FlashShield™ Flexible Gas Piping system may result in fire, explosion or asphyxiation.

This document provides the user with general guidance when designing and installing fuel gas piping using Gastite® or FlashShield™ Flexible Gas Piping. This guideline must be used in conjunction with all applicable building standards and codes. In the event that there is a conflict between this guideline and local code the more stringent requirement will take precedence.

The use of fuel gas can be dangerous. Special attention must be given to the proper design, installation, testing and application of the gas piping system. Sound engineering practices and principles must be exercised, as well as diligent adherence to the proper installation procedures to ensure the safe operation of the piping system. All installed systems must pass customary installation inspections by the local building official having authority prior to being placed into service.

Only the components provided or specified by Gastite as part of the Gastite®/FlashShield™ Flexible fuel piping system are to be used in the installation. Use of components from other flexible gas piping systems other than those specified as part of the Gastite®/FlashShield™ system is prohibited and may result in poor system performance and serious bodily injury or property damage. Where additions, repairs or replacements involve corrugated stainless steel tubing systems from manufacturers other than Gastite Division, the systems should be joined using standard pipe fittings at the interface.

This manual cannot take into account all situations or locations in which Gastite®/FlashShield™ Flexible Gas Piping will be installed. Accordingly, installers should also take into account guidance provided by the National Fuel Gas Code, ANSI Z223.1/NFPA-54, National Standard of Canada, Natural Gas and Propane Installation Code, CSA-B149.1, the Uniform Plumbing Code, the International Code Series, the Federal Manufactured Home Construction and Safety Standards, 24 CFR Part 3280, the Manufactured Housing Construction and Safety Standards, ICC/ANSI 2.0 or the Standard on Manufactured Housing, NFPA 501. Gastite Division shall have no responsibility for any misinterpretation of the information contained in this guide or any improper installation or repair work or other deviation from procedures recommended in this manual, whether pursuant to local building codes or engineering specifications or otherwise.

Gastite Division makes no representation or warranty, and nothing contained in this manual shall imply that this manual contains the best or the only approved method for installing corrugated stainless steel piping systems or that this manual's contents are appropriate for all circumstances. In the event that there is a conflict between this guideline and local code the more stringent requirement will take precedence. Performance of accessory devices, such as pressure regulators and shut off valves should be reconfirmed by contacting the accessory device manufacturer and receiving the latest technical data on sizing, installation and performance.

Continued...

## 1.1 General User Warnings (continued)

A Gastite®/FlashShield™ Flexible Gas Piping system offers advantages over other gas delivery systems because of its wall dimensions and corrugated design. In contrast to rigid steel pipe, Gastite®/FlashShield™ does not require intermediate joints in most installations because the tubing is capable of being installed in one continuous run, reducing not only the total number of joints, but also the potential for leaks at joints. Gastite®/FlashShield™'s flexibility also affords more installation options because an installer can avoid existing obstacles, and it eliminates the repetitive measuring, cutting, threading and joint assembly that are common with installation of rigid steel piping systems. Gastite®/FlashShield™'s flexibility offers even further safety advantages in geographic areas that are prone to seismic activity because the tubing is able to move as the ground or the structure shifts.

While Gastite®/FlashShield™ provides significant advantages over more rigid gas delivery systems, its flexible design may make it more likely than steel pipe to be punctured by a nail or other sharp objects, or damaged by other extraordinary forces such as lightning strike, depending on the circumstances.



Properly bonding and grounding the Corrugated Stainless Steel Tubing (CSST) system may reduce the risk of damage and fire from a lightning strike. Lightning is a highly destructive force. Even a nearby lightning strike that does not strike a structure directly can cause systems in the structure to become electrically energized. Differences in potential between systems may cause the charge to arc between systems. Such arcing can cause damage to CSST, including holes. Bonding and grounding should reduce the risk of arcing and related damage. The building owner should confirm that a qualified contractor has properly bonded the CSST gas system to the grounding electrode system of the premises. Refer to Section 4.10 Electrical Bonding/Grounding in the Gastite®/FlashShield™ Design & Installation Guide for details on bonding & grounding CSST.

All owners should consult a lightning safety consultant to determine whether installation of a lightning protection system would be required to achieve sufficient protection for all building components from lightning. Factors to consider include whether the area is prone to lightning. Areas with high lightning risk include but are not limited to: Arkansas, Florida, Georgia, Illinois, Indiana, Iowa, Kentucky, Louisiana, Maryland, Michigan, Mississippi, Missouri, New Mexico, North Carolina, Ohio, Oklahoma, Pennsylvania, South Carolina, Tennessee, Texas and West Virginia. One currently available source of information regarding areas more prone to lightning than others is the flash density map provided by the National Weather Service which can be found at [http://www.lightningsafety.noaa.gov/lightning\\_map.htm](http://www.lightningsafety.noaa.gov/lightning_map.htm). Lightning protection systems are beyond the scope of this manual and installation guidelines, but are covered by National Fire Protection Association, NFPA 780, the Standard for the Installation of Lightning Protection Systems, and other standards. The owner should confirm with the local gas supply utility company that a suitable dielectric union is installed at the service entry of the structure between underground metallic piping and the gas pipes going into the building as required by code.

Section 250.104b of the National Electric Code (NEC) states that “bonding all piping and metal air ducts within the premises will provide additional safety”. Gastite recommends that all continuous metallic systems be bonded and grounded. The owner should confirm with an electrical or construction specialist that each continuous metallic system in a structure has been bonded and grounded by an electrical professional in accordance with local building codes. This should include, but is not limited to: metallic chimney liners, metallic appliance vents, metallic ducting and piping, electrical cables, and structural steel.

**1.1 General User Warnings (continued)**

Care should be taken when installing any type of fuel gas piping (including CSST, iron, or copper) to maintain as much separation as reasonably possible from other electrically conductive systems in the building. Refer to section 4.3 Routing, in the Gastite®/FlashShield™ D&I Guide for installation techniques. Consult local building codes as to required separations for CSST from such conductive systems including metallic chimney liners, metallic appliance vents, metallic ducting and piping, and electrical cables. See for instance the Indiana Residential Code, section 675 IAC 14-4.3-155.5 Section G2411.1; gas pipe bonding.

Local building codes are controlling, however, as a general practice, fuel gas piping, including CSST, should not be installed within a chase or enclosure that houses a metallic chimney liner or appliance vent that protrudes through the roof. In the event such an installation is necessary and conforms to local building codes, the metallic chimney liner or vent must be bonded and grounded by a qualified electrical professional, and a separation distance, as specifically permitted by the applicable local building code between the CSST and the metallic chimney liner or vent, is required. Physical contact between CSST and the metallic chimney liner and/or vent is prohibited. If this physical separation cannot be specifically identified in the local building code and achieved or any local building code requirements cannot be met along the entire length, then rerouting of the CSST is required unless such installation is specifically permitted by the local building inspector.

NOTE: Leak test solutions may cause corrosion in some types of material in the gas piping system. Be sure to water rinse after the test and thoroughly dry all contacted material.

## 1.2 Limitations of the Guidelines

This document is intended to aid the professional gas installer in the design, installation and testing of fuel gas piping systems using corrugated stainless steel tubing (CSST) for residential housing, commercial and industrial buildings. It would be impossible for this guideline to anticipate and cover every possible variation in building configurations, construction styles, appliance loads and code restrictions. Therefore, there will be applications that will not be covered by this guideline. For applications that go beyond the scope of this guideline, the installer should exercise sound engineering principles and practices and/or contact Gastite for engineering assistance.

The techniques outlined within this guideline are recommended practice for generic applications. These practices must be reviewed for compliance with all applicable local fuel gas and building codes. In the event that there is a conflict between this guide and local code, the more stringent requirement will take precedence.

Using components from other flexible gas piping systems other than those specified as part of the Gastite®/FlashShield™ system is prohibited and may result in poor system performance and serious bodily injury or property damage. Additional information pertaining to gas piping systems is available from your local gas utility or propane supplier. Please visit the Gastite Web site at [www.gastite.com](http://www.gastite.com) for additional updates and technical bulletins.

## 1.3 Standards, Listings and Codes

The Gastite®/FlashShield™ corrugated stainless steel tubing system complies with the following standards, listings and model codes.

### Standards

ANSI LC1, CSA 6.26, “Fuel Gas Piping Systems Using Corrugated Stainless Steel Tubing (CSST).”

### Listings

- CSA – CSA International - Certificate No. 2728525
- ICC – International Code Council – Evaluation Report Number PM6-1019, PMG-1066, PMG-1155
- IAPMO – International Association of Plumbing and Mechanical Officials – File Number 3250, Report #0239

### Code Compliance

- ICC – International Code Series
- National Standard of Canada – National Gas & Propane Installation Code, CAN/CGA-B149.1
- NFPA – National Fuel Gas Code (NFPA 54)
- UMC – Uniform Mechanical Code
- UPC – Uniform Plumbing Code

While every effort has been made to prepare this document in accordance with all regional model codes in effect at its printing, Gastite cannot guarantee that the local administrative authority will accept the most recent version of these codes. It is the ultimate responsibility of the installer to determine suitability and acceptance of any building component including gas piping. Gastite assumes no responsibility for labor or material for installations made without prior determination of local code authority acceptance.



## SECTION 2.0 SYSTEM DESCRIPTIONS & COMPONENTS

### 2.1 System Descriptions

#### 2.1.1 Gastite® System Description

- a) The Gastite® Flexible Gas Piping System has been tested in accordance with the American National Standard for Fuel Gas Systems Using Corrugated Stainless Steel Tubing, ANSI LC1-2005. This standard lists performance requirements for certification of CSST systems for use with all recognized fuel gases, including Natural Gas and Propane.
- System uses corrugated stainless steel tubing (CSST) made of type 304 alloy, ASTM A240.
  - An annealing process tempers the steel giving it added flexibility and ease of bending.
  - Gastite® Flexible Gas Piping is suitable for use with elevated pressure systems. The ANSI LC1 standard rates CSST for use at pressures up to 25PSI.
- b) The tubing is connected using special mechanical brass fittings designed specifically for Gastite® CSST.
- Corrosion resistant brass fittings incorporate the Gastite® patented “Jacket Lock” feature. The polyethylene jacket is clamped by the fitting thereby minimizing the risk of contact with corrosives and foreign material.
  - Gastite® fittings have standard NPT threads and may be used in combination with all approved fuel gas piping materials with the pipe threads as the interface. System components such as manifolds, tees and stub-outs may be fabricated from other approved materials to be used with Gastite® flexible gas piping.
  - The self-flaring fitting creates a one step, reusable, metal on metal seal.
- c) The polyethylene jacket is extruded over the stainless steel tubing creating a flexible, protective covering. The jacket is an added feature of the tubing and does not affect the flaring/sealing process.
- The jacket is engineered with thermal and UV resistant material making it suitable for outdoor use.
  - The polyethylene is fused with flame retardant material making it ASTM E84 25/50 Compliant. As a fire rated material, it meets the requirements for flame spread and smoke density. This allows the jacket to remain intact throughout a building, thus maximizing the protection provided by the jacket.
  - The polyethylene extrusion process creates a smooth outside surface; this surface greatly aids in pulling the tube through tight building spaces.
- d) The corrugated stainless steel tubing system has a number of essential hardware and design differences from conventional gas piping using rigid steel pipe and copper tubing. These differences are described as follows:
- In many applications, the tubing is sized for individual gas appliance loads and is, therefore, usually small in diameter. The tubing may also be installed in a parallel fashion from a central distribution manifold rather than a series layout commonly used for rigid pipe systems.
  - Corrugated Stainless Steel Tubing is pulled through the structure similar in fashion to electrical wiring and therefore requires different handling and installation techniques than rigid pipe.
  - Rigid termination of the tube ends is required.
  - Flexibility and strike plates protect the CSST allowing it to be run in concealed spaces.

### 2.1.2 FlashShield™ System Description

a) The FlashShield™ Flexible Gas Piping System has been tested in accordance with the American National Standard for Fuel Gas Systems Using Corrugated Stainless Steel Tubing, ANSI LC1. This standard lists performance requirements for certification of CSST systems for use with all recognized fuel gases, including Natural Gas and Propane.

FlashShield is also tested and listed in accordance with ICC-ES PMG LC1024 and LC 1027, listing criteria for protective jackets on CSST.

- Metallically shielded
- System uses corrugated stainless steel tubing (CSST) made of type 304 alloy, ASTM A240.
- An annealing process tempers the steel giving it added flexibility and ease of bending.
- FlashShield™ Flexible Gas Piping is suitable for use with elevated pressure systems. The ANSI LC1 standard rates CSST for use at pressures up to 25PSI.

b) The tubing is connected using special mechanical brass fittings designed specifically for FlashShield CSST.

- The FlashShield Jacket-Bite feature penetrates that outer semi-conductive jacket layer, making contact with the metallic shield providing electrical continuity.
- Corrosion resistant brass fittings incorporate the FlashShield™ patented Jacket-Bite™ feature. The jacket is clamped by the fitting thereby minimizing the risk of contact with corrosives and foreign material.
- The use of FlashShield fittings in combination with Gastite yellow tubing is an acceptable practice.
- FlashShield™ fittings have standard NPT threads and may be used in combination with all approved fuel gas piping materials with the pipe threads as the interface. System components such as manifolds, tees and stubouts may be fabricated from other approved materials to be used with FlashShield™ flexible gas piping.
- The self-flaring fitting creates a one step, reusable, metal on metal seal.

c) The multi-layered jacket is extruded over the stainless steel tubing creating a flexible, protective covering. The jacket and metallic shield are added features of the tubing and do not affect the flaring/sealing process.

- Metallically shielded
- Protective jacket/shield is electrically continuous through fitting joints.
- The jacket is engineered with thermal and UV resistant material making it suitable for outdoor use.
- The extrusion process creates a smooth outside surface; this surface greatly aids in pulling the tube through tight building spaces.
- Jacket fused with Flame Retardant marking it ASTM E84 25/50 compliant.

d) The corrugated stainless steel tubing system has a number of essential hardware and design differences from conventional gas piping using rigid steel pipe and copper tubing. These differences are described as follows:

- In many applications, the tubing is sized for individual gas appliance loads and is, therefore, usually small in diameter. The tubing may also be installed in a parallel fashion from a central distribution manifold rather than a series layout commonly used for rigid pipe systems.
- Corrugated Stainless Steel Tubing is pulled through the structure similar in fashion to electrical wiring and therefore requires different handling and installation techniques than rigid pipe.
- Rigid termination of the tube ends is required.
- Flexibility and strike plates protect the CSST allowing it to be run in concealed spaces.

## 2.2 Components

### 2.2.1 Corrugated Stainless Steel Tubing



CSST

GASTITE CORRUGATED STAINLESS STEEL TUBING (CSST)		
Part No.	Description	Pkg. Qty.
<b>S93-6A4-250</b>	<b>3/8" Corrugated Stainless Steel Tubing</b>	<b>250 Ft/Coil</b>
S93-6A4-50 *		50 Ft/Box
S93-6A4-125		500 Ft/Coil
S93-6A4-1000		1000 Ft/Coil
<b>S93-8A4-250</b>	<b>1/2" Corrugated Stainless Steel Tubing</b>	<b>250 Ft/Coil</b>
S93-8A4-50 *		50 Ft/Box
S93-8A4-125		125 Ft/Coil
S93-8A4-500		500 Ft/Coil
S93-8A4-1000		1000 Ft/Coil
S93-8A4-1500		1500 Ft/Coil
<b>S93-11B4-250</b>	<b>3/4" Corrugated Stainless Steel Tubing</b>	<b>250 Ft/Coil</b>
S93-11B4-50 *		50 Ft/Box
S93-11B4-125		125 Ft/Coil
S93-11B4-500		500 Ft/Coil
S93-11B4-1000		1000 Ft/Coil
<b>S93-16A4-150</b>	<b>1" Corrugated Stainless Steel Tubing</b>	<b>150 Ft/Coil</b>
S93-16A4-50 *		50 Ft/Coil
S93-16A4-75		75 Ft/Coil
S93-16A4-300		300 Ft/Coil
S93-16A4-500		500 Ft/Coil
<b>S93-20A4-150</b>	<b>1-1/4" Corrugated Stainless Steel Tubing</b>	<b>150 Ft/Coil</b>
S93-20A4-50 *		50 Ft/Coil
S93-20A4-75		75 Ft/Coil
S93-20A4-300		300 Ft/Coil
<b>S93-24A4-150</b>	<b>1-1/2" Corrugated Stainless Steel Tubing</b>	<b>150 Ft/Coil</b>
S93-24A4-50		50 Ft/Coil
S93-24A4-75		75 Ft/Coil
S93-24A4-300		300 Ft/Coil
<b>S93-32A4-15</b>	<b>2" Corrugated Stainless Steel Tubing</b>	<b>150 Ft/Coil</b>
S93-32A4-50		50 Ft/Coil
S93-32A4-75		75 Ft/Coil
S93-32A4-300		300 Ft/Coil

\* Packaged in box.

*Please contact Gastite Customer Service for custom lengths.*

#### APPLICATION

- CSST flexible gas piping supplies natural gas or liquefied petroleum gas to appliances.

#### MATERIAL / SPECIFICATIONS

- Tubing: ASTM A240 Type 304, Stainless Steel.
- Jacket: UV resistant Polyethylene complying with requirements of ASTM E84 Index for Flame and Smoke.

#### FEATURES AND BENEFITS

- Flexibility and durability allows for simple routing through complex building structures and designs.
- Pre-marked by the foot for easy measuring and installation.
- Minimum tubing wall thickness of .010 on all sizes is more robust than other brands of CSST.
- Annealed 304 stainless steel makes tubing more flexible than brands not heat-treated.

## 2.2.1 Corrugated Stainless Steel Tubing



CSST

## FLASHSHIELD™ CORRUGATED STAINLESS STEEL TUBING (CSST)

Part No.	Description	Pkg. Qty.
FS-8-250	1/2" FlashShield™ Corrugated Stainless Steel Tubing	250 Ft/Coil
FS-8-50 *		50 Ft/Box
FS-8-125		125 Ft/Coil
FS-8-500		500 Ft/Coil
FS-8-1000		1000 Ft/Coil
FS-8-1500		1500 Ft/Coil
<b>FS-11-250</b>	<b>3/4" FlashShield™ Corrugated Stainless Steel Tubing</b>	<b>250 Ft/Coil</b>
FS-11-50 *		50 Ft/Box
FS-11-125		125 Ft/Coil
FS-11-500		500 Ft/Coil
FS-11-1000		1000 Ft/Coil
<b>FS-16-150</b>	<b>1" FlashShield™ Corrugated Stainless Steel Tubing</b>	<b>150 Ft/Coil</b>
FS-16-50 *		50 Ft/Coil
FS-16-75		75 Ft/Coil
FS-16-300		300 Ft/Coil
FS-16-500		500 Ft/Coil
<b>FS-20-150</b>	<b>1-1/4" FlashShield™ Corrugated Stainless Steel Tubing</b>	<b>150 Ft/Coil</b>
FS-20-50		50 Ft/Coil
FS-20-75		75 Ft/Coil
FS-20-300		300 Ft/Coil

\* Packaged in box.

*Please contact Gastite Customer Service for custom lengths.***APPLICATION**

- CSST flexible gas piping supplies natural gas or liquefied petroleum gas to appliances.

**MATERIAL / SPECIFICATIONS**

- Tubing: ASTM A240 Type 304 Stainless Steel.
- Jacket: UV resistant.
- Jacket complies with requirements of ASTM E84 25/50 index for flame and smoke.
- Protective jacket system, complies with ICC-ES PMG LC1024, and LC 1027

**FEATURES AND BENEFITS**

- Metallically shielded CSST.
- Protective shield is electrically continuous through fitting joints.
- Metal mesh layer dissipates and conducts electricity.
- No manufacturer required bonding.
- No special routing requirements or restrictions.
- Annealed 304 stainless steel makes tubing more flexible than brands not heat-treated.
- Minimum tubing wall thickness of .010 on all sizes is more robust than other brands of CSST.
- Flexibility means quick and easy installations. FlashShield™ installs 30-70% faster than traditional piping methods.
- Pre-marked by the foot, there's no measuring, rigid pipe cutting or threading. This means less waste and fewer fittings.
- 75% fewer fittings in the average installation means a safer system, less leak potential and reduced callbacks.
- FlashShield™ CSST is lightweight – 250 feet of 1/2" CSST weighs approximately 50 pounds and can be easily transported and handled on the job.
- Custom lengths of tubing and job-specific accessories for those large and multi-family projects can be easily obtained by a simple telephone call.

2.2.2 Fittings



**Straight Fitting**

**XR2 SERIES STRAIGHT FITTING (ADAPTER/NUT/BUSHING)**

Part No.	Description	Pkg. Qty.
XR2FTG-6-24	3/8" Straight Fitting – 1/2" NPT	24/Box
XR2FTG-8-24	1/2" Straight Fitting – 1/2" NPT	24/Box
XR2FTG-11-24	3/4" Straight Fitting – 3/4" NPT	24/Box
XR2FTG-16-12	1" Straight Fitting – 1" NPT	12/Box
FSFTG-20-6**	1-1/4" FlashShield™ Straight Fitting – 1-1/4" NPT	6/Box
XR2FTG-24-4	1-1/2" Straight Fitting – 1-1/2" NPT	4/Box
XR2FTG-32-4	2" Straight Fitting – 2" NPT	4/Box



**Straight Female Fitting**

**XR2 SERIES STRAIGHT FEMALE FITTING (ADAPTER/NUT/BUSHING)**

Part No.	Description	Pkg. Qty.
XR2FTGFM-8-24	1/2" Straight Fitting – 1/2" Female NPT	24/Box
XR2FTGFM-11-8-24	3/4" Straight Fitting – 1/2" Female NPT	24/Box
XR2FTGFM-11-24	3/4" Straight Fitting – 3/4" Female NPT	24/Box



**Reducing Fitting**

**XR2 SERIES REDUCING FITTING (ADAPTER/NUT/BUSHING)**

Part No.	Description	Pkg. Qty.
XR2REDFTG-11-08-24	3/4" Straight Reducing Fitting – 1/2" NPT	24/Box
XR2REDFTG-16-12-12	1" Straight Reducing Fitting – 3/4" NPT	12/Box



**Tee Fitting**

**XR2 SERIES TEE FITTING**

Part No.	Description	Pkg. Qty.
FST-8-12	1/2" Run x 1/2" Run x 1/2" Tee – Tee Fitting	12/Box
FST-11-12	3/4" Run x 3/4" Run x 3/4" Tee – Tee Fitting	12/Box
FST-16-6	1" Run x 1" Run x 1" Tee – Tee Fitting	6/Box
FST-11-8-8-6	3/4" Run x 1/2" Run x 1/2" Tee – Tee Fitting	6/Box
FST-11-11-8-6	3/4" Run x 3/4" Run x 1/2" Tee – Tee Fitting	6/Box
FST-16-11-8-6	1" Run x 3/4" Run x 1/2" Tee – Tee Fitting	6/Box
FST-16-11-11-6	1" Run x 3/4" Run x 3/4" Tee - Tee Fitting	6/Box
FST-16-16-11-6	1" Run x 1" Run x 1/2" Tee - Tee Fitting	6/Box
FST-16-16-8-6	1" Run x 1" Run x 1/2" Tee - Tee Fitting	6/Box



**Coupling**

**XR2 SERIES COUPLING FITTINGS**

Part No.	Description	Pkg. Qty.
XR2CPL-6-12	3/8" Coupling	12/Box
XR2CPL-8-12	1/2" Coupling	12/Box
XR2CPL-11-12	3/4" Coupling	12/Box
XR2CPL-16-6	1" Coupling	6/Box
FSCPL-20-6**	1-1/4" FlashShield™ Coupling	6/Box
XR2CPL-24-4	1-1/2" Coupling	4/Box
XR2CPL-32-4	2" Coupling	4/Box

**APPLICATION**

- Straight Fittings connect the flexible gas tubing to gas supply, distribution manifolds or gas appliances.
- Tee Fittings create a branch line on tubing runs.
- Couplings allow for the splicing and additions to the flexible gas tubing.

**MATERIAL / SPECIFICATIONS**

- Fitting adapter, bushings and nut – Brass.

**FEATURES AND BENEFITS**

- Tool-less flare design; no special tools are required.
- Metal-to-metal seal, with no split rings, O-rings or gaskets.
- Self-guiding assembly to ensure a perfectly even flare.
- Exclusive, patented Jacket-Lock fitting eliminates exposed stainless steel beyond the nut.
- All components are fully reusable.

\*All FlashShield (FS) Fittings and Tees can be used with Yellow Gastite CSST





## 2.2.2 Fittings

**FLASHSHIELD™ STRAIGHT FITTING (ADAPTER/NUT/BUSHING)****Straight Fitting**

Part No.	Description	Pkg. Qty.
FSFTG-8-24	1/2" FlashShield™ Straight Fitting - 1/2" NPT	24/Box
FSFTG-11-24	3/4" FlashShield™ Straight Fitting - 3/4" NPT	24/Box
FSFTG-16-12	1" FlashShield™ Straight Fitting - 1" NPT	12/Box
FSFTG-20-6	1-1/4" FlashShield™ Straight Fitting - 1-1/4" NPT	6/Box

**FLASHSHIELD™ STRAIGHT FEMALE FITTING (ADAPTER/NUT/BUSHING)****Straight Female Fitting**

Part No.	Description	Pkg. Qty.
FSFTGFM-8-24	1/2" FlashShield™ Straight Fitting - 1/2" Female NPT	24/Box
FSFTGFM-11-8-24	3/4" FlashShield™ Straight Fitting - 1/2" Female NPT	24/Box
FSFTGFM-11-24	3/4" FlashShield™ Straight Fitting - 3/4" Female NPT	24/Box

**FLASHSHIELD™ REDUCING FITTING (ADAPTER/NUT/BUSHING)****Reducing Fitting**

Part No.	Description	Pkg. Qty.
FSREDFTG-11-08-24	3/4" FlashShield™ Straight Reducing Fitting - 1/2" NPT	24/Box
FSREDFTG-16-12-12	1" FlashShield™ Straight Reducing Fitting - 3/4" NPT	12/Box

**FLASHSHIELD™ COUPLING FITTINGS****Coupling**

Part No.	Description	Pkg. Qty.
FSCPL-8-12	1/2" FlashShield™ Coupling	12/Box
FSCPL-11-12	3/4" FlashShield™ Coupling	12/Box
FSCPL-16-6	1" FlashShield™ Coupling	6/Box
FSCPL-20-6	1-1/4" FlashShield™ Coupling	6/Box

Note: Fitting Components available. Please contact Customer Service for pricing.

**APPLICATION**

- Straight Fittings connect the flexible gas tubing to gas supply, distribution manifolds or gas appliances.
- Tee Fittings create a branch line on tubing runs.
- Couplings allow for the splicing and additions to the flexible gas tubing.

**MATERIAL / SPECIFICATIONS**

- Fitting adapter, bushings and nut – Brass.

**FEATURES AND BENEFITS**

- Jacket-Bite™ for continuous conductivity and eliminating exposed stainless steel beyond the nut.
- Tool-less flare design; no special tools are required.
- Metal-to-metal seal, with no split rings, O-rings or gaskets.
- Self-guiding assembly to ensure a perfectly even flare.
- All components are fully reusable.



\*All FlashShield (FS) Fittings and Tees can be used with Yellow Gastite CSST

## 2.2.2 Fittings



**Termination Fitting  
With Square Flange**

**XR2 SERIES TERMINATION FITTING (FLANGE/ADAPTER/NUT/BUSHING)**

Part No.	Description	Pkg. Qty.
XR2TRM-6-12	3/8" Term. Fitting-Square Flange – 1/2" NPT	12/Box
XR2TRM-8-12	1/2" Term. Fitting-Square Flange – 1/2" NPT	12/Box
XR2TRM-11-12	3/4" Term. Fitting-Square Flange – 3/4" NPT	12/Box
XR2TRM-16-6	1" Term. Fitting-Square Flange – 1" NPT	6/Box
FSTRM-20-6*	1-1/4" FlashShield™ Term. Fitting-Square Flange – 1-1/4" NPT	6/Box
XR2TRM-24-4	1-1/2" Term. Fitting-Square Flange – 1-1/2" NPT	4/Box
XR2TRM-32-4	2" Term. Fitting-Square Flange - 2" NPT	4/Box
XR2TRM-6-12CB	3/8" Term. Fitting-Cast Bronze Flange – 1/2" NPT	12/Box
XR2TRM-8-12CB	1/2" Term. Fitting-Cast Bronze Flange – 1/2" NPT	12/Box
XR2TRM-11-12CB	3/4" Term. Fitting-Cast Bronze Flange – 3/4" NPT	12/Box
XR2TRM-16-6CB	1" Term. Fitting-Cast Bronze Flange – 1" NPT	6/Box
FSTRM-20-6CB*	1-1/4" FlashShield™ Term. Fitting-Cast Bronze Flange – 1-1/4" NPT	6/Box
XR2TRM-24-4CB	1-1/2" Term. Fitting-Cast Bronze Flange – 1-1/2" NPT	4/Box



**Termination Fitting  
No Flange**

**XR2 SERIES TERMINATION FITTING WITH NO FLANGE (ADAPTER/NUT/BUSHING)**

Part No.	Description	Pkg. Qty.
XR2TRM-6-NF-12	3/8" Term. Fitting – 1/2" NPT with no Flange	12/Box
XR2TRM-8-NF-12	1/2" Term. Fitting – 1/2" NPT with no Flange	12/Box
XR2TRM-11-NF-12	3/4" Term. Fitting – 3/4" NPT with no Flange	12/Box
XR2TRM-16-NF-6	1" Term. Fitting – 1" NPT with no Flange	6/Box
XR2TRM-20-NF-6	1-1/4" Term. Fitting – 1-1/4" NPT with no Flange	6/Box
XR2TRM-24-NF-4	1-1/2" Term. Fitting – 1-1/2" NPT with no Flange	4/Box
XR2TRM-32-NF-4	2" Term. Fitting – 2" NPT with no Flange	4/Box



**Term Bracket Fitting**

**XR2 SERIES TERMINATION BRACKET FITTING (BRACKET/ADAPTER/NUT/BUSHING)**

Part No.	Description	Pkg. Qty.
XR2TRMBKT-8-12	1/2" Term. Bracket Fitting – 1/2" NPT	12/Box
XR2TRMBKT-11-12	3/4" Term. Bracket Fitting – 3/4" NPT	12/Box
XR2TRMBKT-16-6	1" Term. Bracket Fitting – 1" NPT	6/Box
XR2TRMBKT-20-6	1-1/4" Term Bracket Fitting – 1-1/4" NPT	6/Box
XR2TRMBKT-24-4	1-1/2" Term. Bracket Fitting – 1-1/2" NPT	4/Box
XR2TRMBKT-32-4	2" Term. Bracket Fitting – 2" NPT	4/Box

**APPLICATION**

- Straight Fittings connect the flexible gas tubing to gas supply, distribution manifolds or gas appliances.
- Tee Fittings create a branch line on tubing runs.
- Couplings allow for the splicing and additions to the flexible gas tubing.

**MATERIAL / SPECIFICATIONS**

- Fitting adapter, bushings and nut – Brass.
- Square Flange – Steel with zinc coating.

**FEATURES AND BENEFITS**

- Tool-less flare design; no special tools are required.
- Metal-to-metal seal, with no split rings, O-rings or gaskets.
- Self-guiding assembly to ensure a perfectly even flare.
- Exclusive, patented Jacket-Lock fitting eliminates exposed stainless steel beyond the nut.
- All components are fully reusable.

\*All FlashShield (FS) Fittings and Tees can be used with Yellow Gastite CSST

2.2.2 Fittings

**FLASHSHIELD™ TERMINATION FITTING (FLANGE/ADAPTER/NUT/BUSHING)**

Part No.	Description	Pkg. Qty.
FSTRM-8-12	1/2" FlashShield™ Term. Fitting - 1/2" NPT	12/Box
FSTRM-11-12	3/4" FlashShield™ Term. Fitting - 3/4" NPT	12/Box
FSTRM-16-6	1" FlashShield™ Term. Fitting - 1" NPT	6/Box
FSTRM-20-6	1-1/4" FlashShield™ Term. Fitting - 1-1/4" NPT	6/Box



Termination Fitting With Square Flange

**FLASHSHIELD™ TERMINATION FITTING WITH BRONZE FLANGE (FLANGE/ADAPTER/NUT/BUSHING)**

Part No.	Description	Pkg. Qty.
FSTRM-8-12CB	1/2" FlashShield™ Term. Fitting w/ Bronze Flange - 1/2" NPT	12/Box
FSTRM-11-12CB	3/4" FlashShield™ Term. Fitting w/ Bronze Flange - 3/4" NPT	12/Box
FSTRM-16-6CB	1" FlashShield™ Term. Fitting w/ Bronze Flange - 1" NPT	6/Box
FSTRM-20-6CB	1-1/4" FlashShield™ Term. Fitting w/ Bronze Flange - 1-1/4" NPT	6/Box



Termination Fitting No Flange

**FLASHSHIELD™ TERMINATION FITTING WITH NO FLANGE (ADAPTER/NUT/BUSHING)**

Part No.	Description	Pkg. Qty.
FSTRM-8-NF-12	1/2" FlashShield™ Term. Fitting - 1/2" NPT (no flange)	12/Box
FSTRM-11-NF-12	3/4" FlashShield™ Term. Fitting - 3/4" NPT (no flange)	12/Box
FSTRM-16-NF-6	1" FlashShield™ Term. Fitting - 1" NPT (no flange)	6/Box
FSTRM-20-NF-6	1-1/4" FlashShield™ Term. Fitting - 1-1/4" NPT (no flange)	6/Box

**FLASHSHIELD™ TERMINATION BRACKET FITTING (BRACKET/ADAPTER/NUT/BUSHING)**

Part No.	Description	Pkg. Qty.
FSTRMBKT-8-12	1/2" FlashShield™ Term. Bracket Fitting - 1/2" NPT	12/Box
FSTRMBKT-11-12	3/4" FlashShield™ Term. Bracket Fitting - 3/4" NPT	12/Box
FSTRMBKT-16-6	1" FlashShield™ Term. Bracket Fitting - 1" NPT	6/Box
FSTRMBKT-20-6	1-1/4" FlashShield™ Term. Bracket Fitting - 1-1/4" NPT	6/Box



Term Bracket Fitting

APPLICATION

- Termination Fittings create a fixed point “stub-out” on a wall or floor surface.
- Termination Bracket Fittings provide a secure attachment point for key-valves and as an alternate termination point.

MATERIAL / SPECIFICATIONS

- Fitting adapter, bushings and nut - Brass.
- Square Flange – Steel with zinc coating.

FEATURES AND BENEFITS

- Jacket-Bite™ for continuous conductivity and eliminating exposed stainless steel beyond the nut.
- Tool-less flare design; no special tools are required.
- Metal-to-metal seal, with no split rings, O-rings or gaskets.
- Self-guiding assembly to ensure a perfectly even flare.
- All components are fully reusable.

\*All FlashShield (FS) Fittings and Tees can be used with Yellow Gastite CSST



2.2.3 Manifolds

**MULTI-PORT MANIFOLDS**

Part No.	Description	Pkg. Qty.
3-PORTMAN	Cast 3 port – 3/4" F x 3 @ 1/2" F x 1/2" F	1 Ea.
3-PORTMAN-1	Cast 3 port – 1/2" x 3 @ 1/2" F x 1/2" F	1 Ea.
4-PORTMAN-10	Cast 4 port – 3/4" F x 4 @ 1/2" F x 1/2" F	10/Box
5-PORTMAN	Cast 5 port – 3/4" F x 1 @ 3/4" F x 4 @ 1/2" F x 1/2" F	1 Ea.
5-PORTMAN-1	Cast 5 port – 1" F x 1 @ 3/4" F x 4 @ 1/2" F x 3/4" F	1 Ea.
5-PORTMAN-2	Cast 5 port – 1-1/4" F x 5 @ 3/4" F x 1" F	1 Ea.
5-PORTMAN-3	Cast 5 port – 1-1/4" F x 5 @ 1/2" F x 1" F	1 Ea.
4-PORTMAN-2	Cast 4 port – 1-1/2" F x 4 @ 3/4" F x 1-1/2" F	1 Ea.
4-PORTMAN-3	Cast 4 port – 2" F x 4 @ 1" F x 1-1/2" F	1 Ea.
111596-08	Coated Steel 4 Port – 3/4" F x 4 @ 1/2" F x 3/4" M	1 Ea.



Cast Manifolds

APPLICATION

- Provides central distribution point for individual runs to each appliance.

MATERIAL / SPECIFICATIONS

- Coated 4 Port – Welded IPS Schedule 40 pipe.
- Cast 3, 4, and 5 Port – ASTM A47 32510 Malleable Iron.

2.2.4 Modular Stub System

MODULAR STUB SYSTEM



XR-Appliance Stub-Outs

Part No.	Description	Pkg. Qty.
XR-APSTUB-8-10	1/2" M x 1/2" M x 1-1/2" Stub length with 1/2" female fitting	10/Box
XR-L-APSTUB-8-10	1/2" M x 1/2" M x 2-1/4" Stub length with 1/2" female fitting	10/Box
XR-APSTUB-11-10	1/2" M x 1/2" M x 1-1/2" Stub length with 3/4" female fitting	10/Box
XR-L-APSTUB-11-10	1/2" M x 1/2" M x 2-1/4" Stub length with 3/4" female fitting	10/Box
XR-APSTUB-11-11-10	3/4" M x 3/4" M x 1-1/2" Stub length with 3/4" female fitting	10/Box
XR-L-APSTUB-11-11-10	3/4" M x 3/4" M x 2-1/4" Stub length with 3/4" female fitting	10/Box
FS-APSTUB-8-10	1/2" FlashShield™ x 1-1/2" Stub x 1/2" NPT	10/Box
FS-L-APSTUB-8-10	1/2" FlashShield™ x 2-1/4" Stub x 1/2" NPT	10/Box
FS-APSTUB-11-10	3/4" FlashShield™ x 1-1/2" Stub x 1/2" NPT	10/Box
FS-L-APSTUB-11-10	3/4" FlashShield™ x 2-1/4" Stub x 1/2" NPT	10/Box
FS-APSTUB-11-11-10	3/4" FlashShield™ x 1-1/2" Stub x 3/4" NPT	10/Box
FS-L-APSTUB-11-11-10	3/4" FlashShield™ x 2-1/4" Stub x 3/4" NPT	10/Box



Straight Stub-Outs Optional Brackets

1/2X6STUB-10	1/2" M x 6" L Straight Stub	10/Box
1/2X12STUB-10	1/2" M x 12" L Straight Stub	10/Box
3/4X6STUB-10	3/4" M x 6" L Straight Stub	10/Box
3/4X12STUB-10	3/4" M x 12" L Straight Stub	10/Box
1X6STUB-10	1" M x 6" L Straight Stub	10/Box
1X12STUB-10	1" M x 12" L Straight Stub	10/Box
1-1/4X6STUB-10	1-1/4" M x 6" L Straight Stub	10/Box
1-1/4X12STUB-10	1-1/4" M x 12" L Straight Stub	10/Box
1-1/2X6STUB-10	1-1/2" M x 6" L Straight Stub	10/Box
1-1/2X12STUB-10	1-1/2" M x 12" L Straight Stub	10/Box
2X6STUB-10	2" M x 6" L Straight Stub	10/Box
2X12STUB-10	2" M x 12" L Straight Stub	10/Box
ANGLE-STUB-01-10	1/2" M x 4-1/2" L x 72.5° Angle Stub	10/Box
STUB-BRACE	Stub Bracket (optional) – Fits All	1 Ea.
DBLSTUB-1-10	3/4" Inlet x 1/2" & 3/4" Outlet	10/Box
DECKSTUB-1/2x3-10	1/2" x 3" Bracket Stub-Out	10/Box



Angel Stub-Out



Deck Stub-Out



Double Stub-Out

APPLICATION

- All Stubs create a fixed point “stub-out” on a wall or floor surface for meter and appliance attachment.
- Angle Stub-Out mounting plate provided at a 72-1/2° angle to facilitate mounting to angled side of most fireplace inserts.

MATERIAL / SPECIFICATIONS



- Schedule 40 steel pipe complying with material standard ASTM A-53.
- Exterior plating – Black oxide coating after all threading, forming and welding.

FEATURES AND BENEFITS

- Reduces the number of joints in the system where contractors typically fabricate “stub-outs” from rigid pipe nipples, elbows and couplings.
- Provides a fixed-point termination for installations where the appliances are not yet installed.
- Creates a more polished look to the overall installation.

2.2.5 Mounting Hardware

MOUNTING HARDWARE

	Part No.	Description	Pkg. Qty.
 <b>Termination Bracket</b>	LBRACE-1-20	Term. Fitting Mounting Kit – Fits 3/8" - 1" CSST	20/Box
	MBRACE-1-10	Manifold Mounting Kit – See below for mounting options	10/Box
	MBRACE-3-10	Manifold Mounting Kit – See below for mounting options	10/Box
	GLC1	Gas Load Center Kit – 14-1/2" x 24" x 3-1/2"	1 Ea.
	GLC1-PANEL	Gas Load Center Cover Panel - Vented	1 Ea.
 <b>Manifold Bracket</b>	MSTRAPS-6-250	Metal Tubing Strap – Fits 3/8" CSST	250/Box
	MSTRAPS-8-250	Metal Tubing Strap – Fits 1/2" CSST	250/Box
	MSTRAPS-11-150	Metal Tubing Strap – Fits 3/4" CSST	150/Box
	MSTRAPS-16-100	Metal Tubing Strap – Fits 1" CSST	100/Box
	MSTRAPS-20-50	Metal Tubing Strap – Fits 1-1/4" CSST	50/Box
	MSTRAPS-24-50	Metal Tubing Strap – Fits 1-1/2" CSST	50/Box
	MSTRAPS-32-25	Metal Tubing Strap – Fits 2" CSST	25/Box
	XR2OUTLETBOX-8	Recessed gas outlet box kit with 1/2" XR2 Fitting	1 Kit
XR2OUTLETBOX-11	Recessed gas outlet box kit with 3/4" XR2 Fitting	1 Kit	
XR2OUTLETBOX-FR8	Firestop gas outlet box kit with 1/2" XR2 Fitting	1 Kit	
XR2OUTLETBOX-FR11	Firestop gas outlet box kit with 3/4" XR2 Fitting	1 Kit	
 <b>Gas Load Center</b>	FSOUTLETBOX-8	Recessed Gas Outlet Box w/ 1/2" FlashShield™ Fitting	1 Kit
	FSOUTLETBOX-11	Recessed Gas Outlet Box w/ 3/4" FlashShield™ Fitting	1 Kit
	FSOUTLETBOX-FR8	Recessed FireStop Gas Outlet Box w/ 1/2" FlashShield™ Fitting	1 Kit
	FSOUTLETBOX-FR11	Recessed FireStop Gas Outlet Box w/ 3/4" FlashShield™	10/Box

APPLICATION



- Termination Bracket provides mounting surface for termination fitting assembly.
- Manifold Bracket provides mounting platform for manifolds, supplied with adhesive port labeling.
- Gas Load Center creates a recessed cabinet for a more polished look to manifold assembly.
- XR2OUTLETBOX creates a secure recessed termination point for connection to moveable appliances.

MATERIAL / SPECIFICATIONS

- Termination Fitting – 16 gauge galvanized sheet metal.
- MBRACE-1 Mounting Kit made of 16 gauge galvanized sheet metal. - Fits 3-PORTMAN, 4-PORTMAN, 5-PORTMAN and 111596-08.
- MBRACE-3 Mounting Kit made of 14 gauge galvanized sheet metal. - Fits 5-PORTMAN-1, 5-PORTMAN-2, 5-PORTMAN-3 and 4-PORTMAN-2.
- 4-PORTMAN-3 requires installer supplied mounting brackets.
- Gas Load Center – 20 gauge steel with a white, polyester powder coat finish.
- Metal Tubing Straps – 22, 20 or 18 gauge sheet metal, depending on size.

2.2.6 Pipe Support System

PIPE SUPPORT SYSTEM

	Part No.	Description	Pkg. Qty.
 <b>RB0</b>	RB0-10-4	Rubber Support Block (10"L x 4"H)	1 Ea.
	RB1-10-5	Rubber Support Block w/ 7/8" Galv Steel Channel (10"L X 5"H)	1 Ea.
	RB1-29-5	Rubber Support Block w/ 7/8" Galv Steel Channel (29"L X 5"H)	1 Ea.
	RB2-10-12	Rubber Support Block w/Adj height 7/8" Galv Steel Channel (10"L x 5"-12"H)	1 Ea.
 <b>RB1</b>			
 <b>RB2</b>			

APPLICATION

- Effectively anchors and supports lightweight Gastite CSST, as well as other fuel gas piping materials to any roofing membrane.

MATERIAL / SPECIFICATIONS

- Made of 100% recycled material, UV resistant and waterproof.
- Will not damage expensive roof membranes.
- Installs on any roof with or without standard roof adhesives.



2.2.7 Strike Protection

PROTECTION DEVICES – STRIKER PLATES & SILICONE TAPE

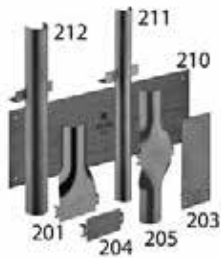

Striker Plates

Part No.	Description	Pkg. Qty.
TFM204-100	Quarter Striker Plate – 3" x 2"	100/Box
TFM201-50	Half Striker Plate – 3" x 7"	50/Box
TFM203-50	Three-Quarter Striker Plate – 3" x 8"	50/Box
TFM205-25	Full Striker Plate – 3" x 12"	25/Box
TFM210-10	6" x 17" Striker Plate	10/Box
TFM211-25	Full (Drop-In) Striker Plate – 1/2" & 3/4" CSST	25/Box
TFM212-25	Full (Drop-In) Striker Plate – 1" & 1 1/4" CSST	25/Box
SIL-TAPE	Self Bonding Silicone Tape – 1" x .015" x 12 yd / roll	1 Ea.



Steel Conduit Coil & Cut Length

Part No.	Description	Pkg. Qty.
FLOPPY12	3/4" Coil steel conduit – Fits 3/8" CSST	50 Ft/Coil
FLOPPY16	1" Coil steel conduit – Fits 1/2" CSST	50 Ft/Coil
FLOPPY20	1-1/4" Coil steel conduit – Fits 3/4" CSST	25 Ft/Coil
FLOPPY24	1-1/2" Coil steel conduit – Fits 1" CSST	25 Ft/Coil
FLOPPY28	1-3/4" Coil steel conduit – Fits 1-1/4" CSST	25 Ft/Coil
FLOPPY36	2-1/4" Coil steel conduit – Fits 1-1/2" CSST	25 Ft/Coil
FLOPPY48	3" Coil steel conduit – Fits 2" CSST	25 Ft/Coil

Part No.	Description	Pkg. Qty.
LFLOPPY-12-50	3/4" – Cut to 1 foot length – Fits 3/8" CSST	50/Box
LFLOPPY-16-50	1" – Cut to 1 foot length – Fits 1/2" CSST	50/Box
LFLOPPY-20-25	1-1/4" – Cut to 1 foot length – Fits 3/4" CSST	25/Box
LFLOPPY-24-25	1-1/2" – Cut to 1 foot length – Fits 1" CSST	25/Box
LFLOPPY-28-25	1-3/4" – Cut to 1 foot length – Fits 1-1/4" CSST	25/Box
LFLOPPY 36-25	2-1/4" – Cut to 1 foot length – Fits 1-1/2" CSST	25/Box
LFLOPPY-48-25	3" – Cut to 1 foot length – Fits 2" CSST	25/Box

APPLICATION

- Striker plates used for protection where flexible gas piping passes through structural members and is restricted from moving to avoid nails, screws and other potential puncture threats.
- Steel conduit is used to provide additional protection where striker plates cannot be easily installed.

MATERIAL / SPECIFICATIONS

- Striker Plates – 16 gauge AISI1050 Carbon Steel Hardened to Rc 45.
- Steel Conduit – Strip wound interlocking steel.

2.2.8 Shut-Off Valves and Quick Connects

SHUT-OFF VALVES



Ball Valve 90° Ball Valve

Part No.	Description	Pkg. Qty.
T100-1/2-20	1/2" Ball Valve rated to 125 ps	20/Box
T100-3/4-10	3/4" Ball Valve rated to 125 psi	10/Box
T100-1-1/4-5	1-1/4" Ball Valve rated to 125 psi	5/Box
T90-1/2-10	1/2" 90 Degree Shut-Off Valve	10/Box
T90-3/4-10	3/4" 90 Degree Shut-Off Valve	10/Box

QUICK CONNECT AND ACCESSORIES



Stainless Steel & PVC Quick Connect Boxes

Part No.	Description	Pkg. Qty.
T103029	1/2" Quick Connect Valve	1 Ea.
OUTFLEX-3/8	Outdoor Flex Connector – 3/8" NPT x 12'	1 Ea.
QCBOXPW	1/2" Quick Connect Box White PVC- Surface Mounted	1 Ea.
QCBOXPG	1/2" Quick Connect Box Gray PVC- Surface Mounted	1 Ea.
QCBOXSS	1/2" Quick Connect Box - Stainless Steel Door, PVC Box - Recess Mounted	1 Ea.

APPLICATION

- Ball Valves are used to control gas flow to appliances and pounds-to-inches regulator.
- Quick-Connect valve and accessories provide a safe and easy “quick-connect” for barbecue grills, space heaters and decorative lighting.

MATERIAL / SPECIFICATIONS

- Ball Valve - ANSI/ASME B16.33.
- Quick Connect and Accessories – ANSI Z21.15, CAN 9.1,9.2, 6.9 and AGA/CGA 7-90/CR94-001.

2.2.9 Gastite Accessories

TUBING CUTTERS AND ACCESSORIES



Tubing Cutters

Part No.	Description	Pkg. Qty.
GTCUTTER-SM	Cutter with flat rollers – 3/8" – 1"	1 Ea.
GTCUTTER-LG	Cutter with flat rollers – Up to 2"	1 Ea.
GTBLADE-SM-5	Replacement blade for GTCUTTER-SM	5 Ea.
GTBLADE-LG-5	Replacement blade for GTCUTTER-LG	5 Ea.

APPLICATION

- Tubing Cutters, fitted with cutting wheel designed to cut stainless steel, create clean cuts for optimal flaring of tubing.

MATERIAL / SPECIFICATIONS

- Aluminum alloy body.

2.2.10 Bonding Clamps



Bonding Clamps

BONDING CLAMPS

Part No.	Description	Pkg. Qty.
CWP1JSH	Bonding Clamp for 3/8" and 1/2" CSST	1 Ea.
CWP2JSH	Bonding Clamp for 3/4", 1" and 1-1/4" CSST	1 Ea.
CWP3JSH	Bonding Clamp for 1-1/2" and 2" CSST	1 Ea.

2.2.11 System Identification



Adhesive Label

SYSTEM IDENTIFICATION

Part No.	Description	Pkg. Qty.
EPAL-1-100	Adhesive Labels for elevated pressure identification	100/Roll
EPMT-1-100	Metal Tags for Uniform Plumbing Code compliance	100/Pkg.



Metal Tag

## 2.2.12 Regulators



Maxitrol Regulators

Maxitrol Regulators  
with OPD

OARA Regulators

## MAXITROL REGULATORS

Part No.	Description	Pkg. Qty.
T325-3-44	250 MBTU of NG @ 8" w.c. with 1/2" NPT inlet/outlet	1 Ea.
T325-3-44P	355 MBTU of LP @ 11" w.c. with 1/2" NPT inlet/outlet	1 Ea.
T325-5-2	425 MBTU of NG @ 8" w.c. with 1/2" NPT inlet/outlet	1 Ea.
T325-5-44	600 MBTU of NG @ 8" w.c. with 3/4" NPT inlet/outlet	1 Ea.
T325-5-44P	918 MBTU of LP @ 11" w.c. with 3/4" NPT inlet/outlet	1 Ea.
T325-5-3	600 MBTU of NG @ 8" w.c. with 1" NPT inlet/outlet	1 Ea.
T325-5-3P	550 MBTU of LP @ 11" w.c. with 1" NPT inlet/outlet	1 Ea.
T325-7AL-NG01	1,250 MBTU of NG @ 8" w.c. with 1-1/4" NPT inlet/outlet	1 Ea.
T325-3L48	200 MBTU of NG @ 8" w.c. with 1/2" NPT inlet/outlet & OPD	1 Ea.
T325-5AL600	425 MBTU of NG @ 8" w.c. with 3/4" NPT inlet/outlet & OPD	1 Ea.
T325-7L-210D*	1,250 MBTU of NG @ 8" w.c. with 1-1/4" NPT inlet/outlet & OPD	1 Ea.

## OARA REGULATORS

Part No.	Description	Pkg. Qty.
REG8-300	250 MBTU of NG @ 8" w.c. with 1/2" NPT inlet/outlet	1 Ea.
REG11-300	355 MBTU of LP @ 11" w.c. with 1/2" NPT inlet/outlet	1 Ea.
REG8-600	550 MBTU of NG @ 8" w.c. with 3/4" NPT inlet/outlet	1 Ea.
REG11-600	810 MBTU of LP @ 11" w.c. with 3/4" NPT inlet/outlet	1 Ea.
VP3	Outdoor Vent Protector (325-3), 1/8" NPT	1 Ea.
VP5	Outdoor Vent Protector (325-5), 3/8" NPT	1 Ea.
VLP-3	Vent Line Protector for end termination	1 Ea.

\*Vent limiters not available.

Note: Pipe thread size should never be used to determine regulator sizing.  
Please refer to section 4.9 for proper regulator selection

## APPLICATION

- For use in elevated pressure systems (in excess of 1/2 psi) to reduce pressure to standard appliance use levels.
- Outdoor vent protector is used when vent-limiting orifice is removed for outdoor installation of regulator.

## MATERIAL / SPECIFICATIONS

- 2 psi inlet pressure line models available in 8" w.c. and 11" w.c. outlet pressures.
- 5 psi inlet pressure (OPD) models available in 8" w.c. (field adjustment to 11" w.c.) outlet pressures.

Pietro Fiorentini  
Regulators

## Pietro fiorentini regulators

Part No.	Description	Pkg. Qty.
30051-NG	635 MBTU of NG @ 8" w.c. with 1/2" NPT inlet/outlet	1 Ea.
30052-NG	848 MBTU of NG @ 8" w.c. with 3/4" NPT inlet/outlet	1 Ea.
30053-NG	1,059 MBTU of NG @ 8" w.c. with 1" NPT inlet/outlet	1 Ea.
30153-NG	5,297 MBTU of NG @ 8" w.c. with 1-1/4" NPT inlet/outlet	1 Ea.
30052-LP	1,285 MBTU of LP @ 11" w.c. with 3/4" NPT inlet/outlet	1 Ea.

# NOTES

# GASTITE®/FLASHSHIELD™ CSST WORKSHEET

**PROJECT / LOCATION:**

**DRAWN BY:**

**CONTACT PHONE:**

**DATE:**

**DESCRIPTION**

**SYSTEM DESCRIPTION**

**SYSTEM DATA AND REQUIREMENTS**

	Name of Run	Supply Pressure (Lbs. or In.)	Length of Run (Ft)	Load of Run (CFH)	Press. Drop (LBS. or In.)	Tube Diameter (Size or In.)	Delivery Press. (LBS. or In.)	Comments
A								
B								
C								
D								
E								
F								
G								
H								
I								
J								
K								
L								
M								
N								
O								

To be copied: For Planning and Design of the Gastite®/FlashShield Piping System. Visit [www.gastite.com](http://www.gastite.com) for a downloadable version of this worksheet.



## SECTION 3.0 SYSTEM CONFIGURATION

### 3.1 Configuration

#### 3.1.1 Introduction

This section is intended to help in the design and sizing of both Gastite® and FlashShield™ CSST fuel gas piping systems. The form -printed on the previous page is to aid in keeping track of the system requirements as well as organizing the system configuration and sizing numbers. Refer to the Gastite Web site ([www.gastite.com](http://www.gastite.com)) for additional sizing tools.

The Gastite®/FlashShield™ gas piping system is required to be tested, listed, and installed in accordance with the Standard For Fuel Gas Piping Systems Using Corrugated Stainless Steel Tubing, ANSI LC1-2005. This standard, among other things, requires the manufacturer to provide installation instructions including the necessary pipe sizing tables and methods of sizing.

#### 3.1.2 System Requirements

- Determine the local piping restrictions prior to installing the flexible gas piping. Confirm that the local administrative authority has accepted the use of flexible gas piping. Corrugated Stainless Steel Tubing has been accepted by all major code bodies, but local or state adoption of these codes often lags behind. Check with the local administrative authority or an authorized Gastite®/FlashShield distributor for approval in your area.
- Determine metered (supply) pressure. A gauge can be used to measure the supply pressure or the utility will provide a supply pressure rating.
- Determine appliance demand. Every appliance will have a manufacture's nameplate containing BTUH or CFH requirements as well as minimum and maximum operating pressures.
- Refer to building plans or prepare a sketch showing the location of each appliance. When preparing this sketch keep in mind the safest, easiest, and shortest distance locations to run the piping. Label the pipe segments and the corresponding lengths. Take note of fittings needed e.g. tees, manifolds, reducers.

#### 3.1.3 Reference Data for Proper System Sizing

- Determine the total capacity needed for all appliances. CFH or BTUH equivalents for natural gas or propane can be obtained from the local gas utility or propane supplier. The capacity tables within this guide or other approved CSST tables should be used to determine pipe sizing for both Gastite® and FlashShield needed to meet BTUH input load requirements.

Pressure Conversion Factors			Fuel Gas Information		
1/4 psi =	6.921"WC =	(approx. 7"WC)		Natural Gas	Propane
1/2 psi =	13.842"WC =	(approx. 14"WC)	BTU per Cubic Foot =	1000	2516
1 psi =	27.684"WC =	(approx. 28"WC)	Specific Gravity =	0.6	1.52
2 psi =	55.368"WC =	(approx. 56"WC)	Note: "Pressure Drop Curves for Gastite® CSST" are expressed in terms of Cubic Feet per Hour (CFH). To determine the CFH for Natural Gas, divide the BTU load by 1000. To determine the CFH for Propane, divide the BTU load by 2516.		
5 psi =	138.42"WC =	(approx. 140"WC)			

Refer to Section 7.0 for gases with a specific gravity other than 0.60.

3.1.4 Determining System Layout

a) Series Systems

A series layout (Fig 3-1) is the most common arrangement utilized for rigid pipe systems for low pressure. These usually consist of a main run (header) with tees branching off to each appliance. In a traditional series system, the service pressure down stream of the meter is typically less than 1/2 PSI.

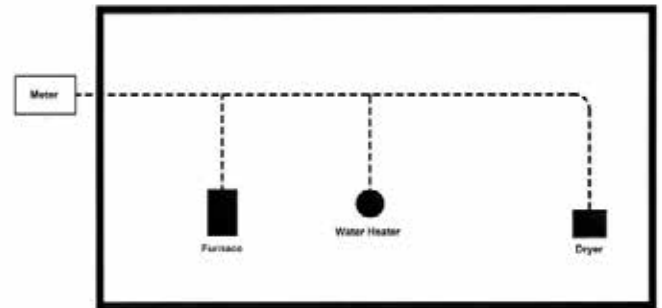

Fig. 3-1

b) Parallel Systems

In a parallel system (Fig. 3-2) a main run from the meter supplies a central distribution manifold. The appliances are serviced by individual runs from the manifold. The manifold station is best located close to the greatest load, typically the boiler or furnace.

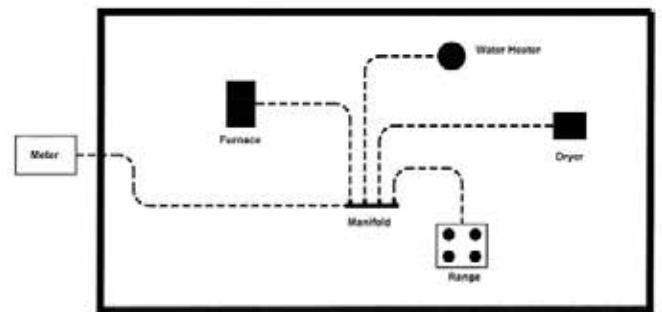

Fig. 3-2

c) Dual Pressure System

A Dual Pressure system (Fig. 3-3, 3-4) incorporates two operating pressures downstream from the meter. The first pressure, set by the service regulator at the meter, is usually 2 PSI but can be higher or lower depending on code restrictions and gas company policy. This part of the system is sized separately and ends at the pounds-to-inches regulator inlet. Tables 4-7, 4-8 and 4-9 show maximum loads vs. inlet pressures to the regulator.

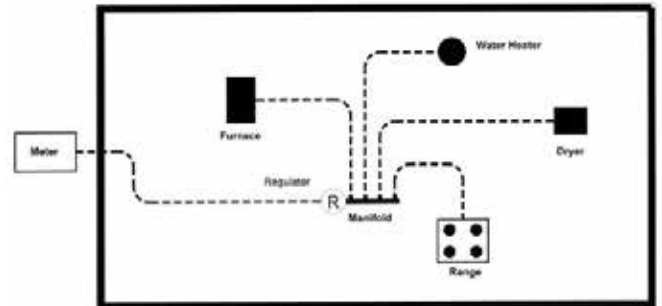

Fig. 3-3

The second pressure, at the outlet of the pounds-to-inches regulator, is under 1/2 PSI; usually 8"WC for natural gas and 11"WC for propane regulators supplied by Gastite®. Generally, a parallel system requires a higher total footage of smaller diameter tubing and fewer fittings compared to a series layout.

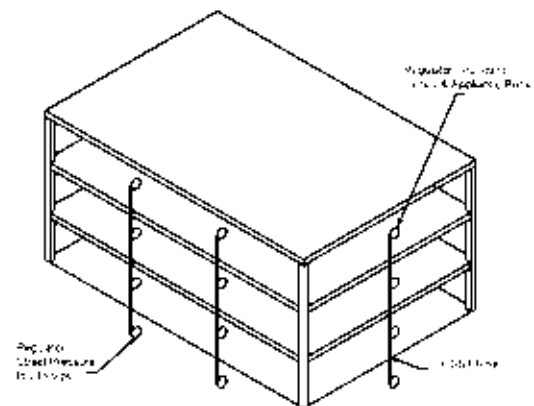

Fig. 3-4 Multi-Unit Apartment Building

d) **Multiple Manifold Systems**

For those installations in which the energy load demand is large or the appliances are installed throughout the structure with long distances from the meter, a multiple manifold system may be used (Fig. 3-5, 3-6). Elevated pressure systems are a safe, efficient method of providing for larger BTUH load demands while maintaining smaller pipe diameters.

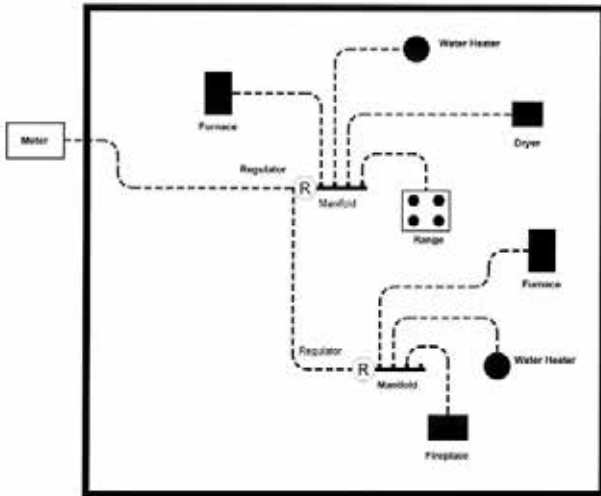

Fig. 3-5

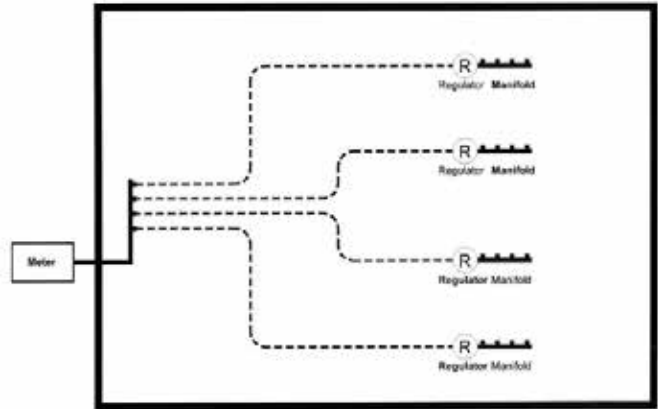

Fig. 3-6

e) **Combination Steel / CSST System (Hybrid)**

In a hybrid system (Fig. 3-7), corrugated stainless steel tubing is used in combination with rigid pipe or copper tubing. In lower pressure systems it is often advantageous to use both CSST and rigid pipe to help minimize pressure drops typically encountered on systems with high loads and/or long runs. Gastite flexible Gas Piping is approved for use in combination with all approved fuel gas-piping materials by using approved pipe threads at the interface.

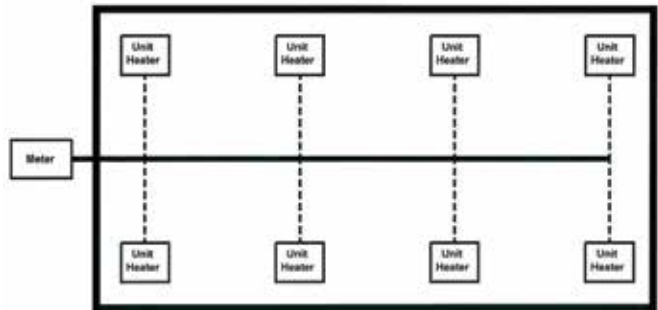

Fig. 3-7

f) **Elevated Pressure System**

In a complete elevated pressure system (Fig. 3-8), corrugated stainless steel tubing is used to deliver pressures in excess of 1/2 PSI to a pounds-to-inches regulator positioned directly in front of each appliance. This is an alternate method of installation used to minimize pipe size on systems with high loads and/or long runs. Regulators shall be sized per the largest single appliance, see Table 4-10.

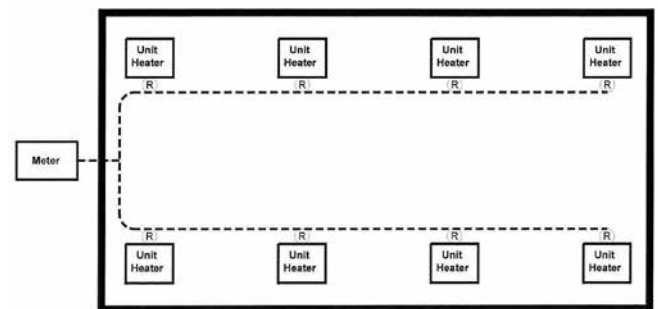

Fig. 3-8

### 3.1.5 Allowable Pressure Drop

With respect to gas pipe sizing, the intent of all model codes is to ensure that there is sufficient gas volume and pressure supplied to the appliance for proper operation. Language from the International Fuel Gas Code clearly illustrates this point.

*“Allowable Pressure Drop: The design pressure loss on any piping system under maximum probable flow conditions, from point of delivery to the inlet connection of the equipment, shall be such that the supply pressure at the equipment is greater than the minimum pressure required for proper equipment operation.”*

The Gastite®/FlashShield™ low-pressure tables are intended for use at a system pressure of 1/2 PSI or less, which encompasses the range of commonly delivered utility pressures and equipment requirements. To determine which table to use determine the system’s allowable pressure drop. The appropriate pressure drop can be calculated by subtracting the appliance inlet pressure (typically 5"WC for NG, 10.5"WC for LPG) from the gas source pressure (gas meter for NG, secondary regulator for LPG). Use the Gastite®/FlashShield capacity table labeled with the appropriate allowable pressure drop and gas type. Increasing the available pressure drop will increase the available BTUHs, thus decreasing pipe sizes. It is advantageous to allow for a larger pressure drop.

The Summation Method of pipe sizing calculates the actual pressure loss through each section of pipe. The sum of all the losses is subtracted from the starting supply pressure to determine the inlet pressure to each appliance. The appliance inlet pressure must fall within the manufacturer’s range for proper operation.

Note: Regardless of sizing method employed, the typical NG system should be sized for a minimum appliance inlet pressure of 5"WC and 10.5"WC for LPG system. Pressures less than the typical minimums may be sufficient for proper appliance operation but should be reviewed with the manufacturers’ input rating and the local administering authority. Conversely, some modern higher performance appliances require an inlet pressure greater than the typical minimums. Check the manufacturers’ input rating before sizing.

### 3.1.6 Sizing Methods

Capacity Tables from this Guide (Section 7) or appropriate code approved tables must be used when sizing Gastite®/FlashShield™ CSST. The sizing tables used in this manual include losses for four 90-degree bends, and two end fittings. Tubing runs with larger numbers of bends and/or fittings should be increased by an equivalent length of tubing to the following equation:  $L = 1.3 (N)$ : where “L” is additional length of tubing, and “N” is the number of additional fittings, or 90 degree bends.

Gastite®’s Longest Run tables and Summation tables are produced from the same fluid flow equations. As such, they will provide the same results taking into account any rounding of distance or capacity. These fluid equations come from data produced by a third party laboratory. The testing was performed on actual Gastite®/FlashShield™ CSST while tables in the code reflect the most restrictive CSST.

#### The Longest Run Method:

A modified version of the longest run (commonly used in conventional rigid pipe systems) is presented here and used in Examples 1, 2 & 3. This method may be used for any pressure as listed in the appropriate Capacity Table.

For sizing each length of pipe, determine the total gas load for all appliances serviced by that section and the maximum distance over which that particular section delivers gas. The maximum distance includes overall length from the meter to the furthest appliance serviced by that run. Refer to Section 7 Capacity Tables for the maximum flow capacity of CSST at the required piping length.

For sizing dual-pressure systems, the piping from the meter to the pounds-to-inches regulator is sized separately from the piping downstream of the regulator outlet. This procedure is shown in Examples 4 & 5.

Sizing for a Hybrid System (one that includes both rigid pipe and CSST) is accomplished by using the longest run method to determine the appropriate pipe size for a given load and run length. Each segment of the piping system uses the appropriate sizing table for that particular piping material. This procedure is shown in Examples 6 & 7.

### **Summation Method:**

An alternative sizing method is the Summation Method which considers a summation of the pressure losses through each section of piping. This procedure is utilized for the designer whose requirements are not satisfied by the previously described methods. The summation method can be used for system pressures and pressure drops other than indicated in the sizing tables for longest run. This method allows full use of the maximum flow capacity of CSST. In this fashion, a designer can minimize piping size (or maximize flow capacity) with greater accuracy in more complicated arrangements. The summation method is shown in Examples 8 & 9.

#### **3.1.7 Modifying an Existing System**

Gastite®/FlashShield™ fittings transition from CSST to pipe thread (NPT) and may be run in conjunction with all other approved fuel gas piping (iron pipe, polyethylene tubing, copper tubing, etc.). When adding appliances to an existing system the installer must verify whether the existing system, upstream of the lines to be added, can support the additional load.

A retrofitted line, even when properly sized, added to a system that can't support the additional load, can adversely effect all the other appliances in the system.

When the existing system will not support the additional load several installation options exist. A new trunk line(s) can be run replacing the under-sized system upstream of the retrofitted appliances. A dedicated trunk line can be run from the gas source to the new appliance. The system pressure may be elevated, thus increasing the allowable pressure drop, after which the existing trunk lines may afford sufficiently higher flow capacity to handle the existing and new appliances.

If the piping is visible or the existing run lengths are known, the entire system can be resized using either aforementioned sizing method (Longest Run or Summation). The system shall be resized with an appropriate sizing table based on the affordable pressure drop. When the piping is not visible or accessible for measurement, approximated lengths should be rounded up.

### **3.2 Sizing Procedures and Exercises**

#### **3.2.1 Sizing Examples**

While the following examples show typical applications of the sizing methods they do not address all of the system configurations in which they can be used. In general, Longest Run and Summation can be used with any pressure or system configuration (series, parallel, dual-pressure, hybrid, etc.).

The following exercises illustrate various design layouts, pressure drops and sizing methods. To further highlight the differences in methods and designs, examples 1-8 use the same appliance layout and load.



3.2.2 Example 1 - Series System – 6"WC

Figure 3-9 below shows a typical single-family house installation with five (5) appliances. The piping is arranged in series with a main run branching at the appliances. The utility company’s supply pressure (downstream of the meter) is 6"WC. The utility company advises that the specific gravity of the gas delivered will be 0.60 and the energy content is 1 CFH = 1000 BTUH. The allowable pressure drop across the system has been determined to be 1.0"WC (supply pressure 6"WC – appliance requirement 5"WC).

Fig. 3-9

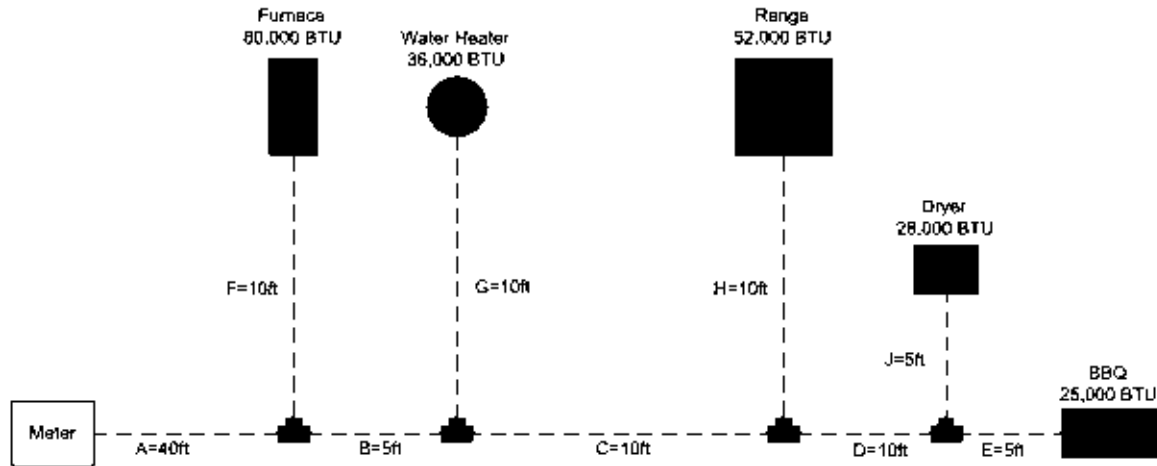

Table 3-2

Section Description	Load Delivered by Section	Section Length	Run Length	Tube Size
"A" – Trunk	221 CFH = 221,000 BTUH	40 feet	70 feet	1" CSST
"B" – Trunk	141 CFH = 141,000 BTUH	5 feet	70 feet	1" CSST
"C" – Trunk	105 CFH = 105,000 BTUH	10 feet	70 feet	1" CSST
"D" – Trunk	53 CFH = 53,000 BTUH	10 feet	70 feet	3/4" CSST
"E" – BBQ	25 CFH = 25,000 BTUH	5 feet	70 feet	1/2" CSST
"F" – Furnace	80 CFH = 80,000 BTUH	10 feet	50 feet	3/4" CSST
"G" – Water Heater	36 CFH = 36,000 BTUH	10 feet	55 feet	1/2" CSST
"H" – Range	52 CFH = 52,000 BTUH	10 feet	65 feet	3/4" CSST
"J" – Dryer	28 CFH = 28,000 BTUH	5 feet	70 feet	1/2" CSST
Run Length for Trunk Sections = Distance from meter to furthest appliance (Longest Run)				
Run Length for Appliance Sections = Distance from meter to each appliance				

SIZING RUN "A"

- Run "A" is sized by the total load of all appliances and the run length from the meter to the furthest appliance
- The total load of all appliances is 80 + 36 + 52 + 28 + 25 = 221CFH
- The run length to the BBQ (furthest appliance) is 40 + 5 + 10 + 10 + 5 = 70ft
- Referring to Table 7-2 (1.0"WC pressure drop): for a 70ft run, 1" CSST has a capacity over 221CFH (actual: 227)

SIZING RUN "B"

- Run "B" is sized by the total load of all supplied appliances and the run length from the meter to the furthest appliance
- The total load of the supplied appliances is 36 + 52 + 28 + 25 = 141CFH
- The run length to the BBQ (furthest appliance) is 40 + 5 + 10 + 10 + 5 = 70ft
- Referring to Table 7-2 (1.0"WC pressure drop) for a 70ft run, 1" CSST has a capacity over 141CFH (actual: 227)

**SIZING RUN “C”**

- Run “C” is sized by the total load of all supplied appliances and the run length from the meter to the furthest appliance
- The total load of all appliances is  $52 + 28 + 25 = 105\text{CFH}$
- The run length to the BBQ (furthest appliance) is  $40 + 5 + 10 + 10 + 5 = 70\text{ft}$
- Referring to Table 7-2 (1.0"WC pressure drop): for a 70ft run, 1" CSST has a capacity over 105CFH (actual: 227)

**SIZING RUN “D”**

- Run “D” is sized by the total load of all supplied appliances and the run length from the meter to the furthest appliance
- The total load of the BBQ and the dryer is  $25 + 28 = 53\text{CFH}$
- The run length to the BBQ (furthest appliance) is  $40 + 5 + 10 + 10 + 5 = 70\text{ft}$
- Referring to Table 7-2 (1.0"WC pressure drop) for a 70ft run, 3/4" CSST has a capacity over 53CFH (actual: 103)

**SIZING RUN “E”**

- Run “E” is sized by the total load of the supplied appliance and the run length from the meter to the furthest appliance
- The load of the BBQ is 25CFH
- The run length to the BBQ is  $40 + 5 + 10 + 10 + 5 = 70\text{ft}$
- Referring to Table 7-2 (1.0"WC pressure drop) for a 70ft run, 1/2" CSST has a capacity over 25CFH (actual: 50)

**SIZING RUN “F”**

- Run “F” is sized by the load of the supplied appliance and the run length from the meter to the supplied appliance
- The load of the furnace is 80CFH
- The run length to the furnace is  $40 + 10 = 50\text{ft}$
- Referring to Table 7-2 (1.0"WC pressure drop) for a 50ft run, 3/4" CSST has a capacity over 80CFH (actual: 120)

**SIZING RUN “G”**

- Run “G” is sized by the load of the supplied appliance and the run length to the supplied appliance
- The load of the water heater is 36CFH
- The run length to the water heater is  $40 + 5 + 10 = 55\text{ft}$
- Referring to Table 7-2 (1.0"WC pressure drop) for a 60ft run, 1/2" CSST has a capacity over 36CFH (actual: 54)

**SIZING RUN “H”**

- Run “H” is sized by the load of the supplied appliance and the run length to the supplied appliance
- The load of the range is 52CFH
- The run length to the range is  $40 + 5 + 10 + 10 = 65\text{ft}$
- Referring to Table 7-2 (1.0"WC pressure drop) for a 70ft run, 3/4" CSST has a capacity over 52CFH (actual: 103)

**SIZING RUN “J”**

- Run “J” is sized by the load of the supplied appliance and the run length to the supplied appliance
- The load of the dryer is 28CFH
- The run length to the dryer is  $40 + 5 + 10 + 10 + 5 = 70\text{ft}$
- Referring to Table 7-2 (1.0"WC pressure drop) for a 70ft run, 1/2" CSST has a capacity over 28CFH (actual: 50)

3.2.3 Example 2 - Parallel System – 6"WC

Figure 3-10 below shows the same house as Example 1. The piping is arranged in parallel fashion, with individual CSST appliance runs supplied by a main distribution manifold. The utility company’s supply pressure (downstream of the meter) is 6"WC. The utility company advises that the specific gravity of the gas delivered will be 0.60 and the energy content is 1 CFH = 1000 BTUH. The allowable pressure drop across the system has been determined to be 1.0"WC (supply pressure 6"WC - appliance requirement 5"WC).

Fig. 3-10

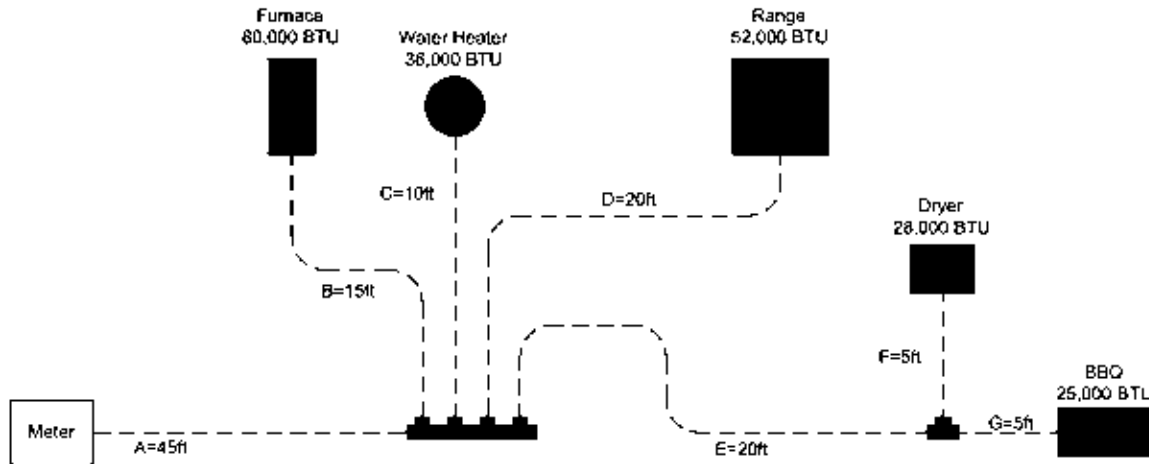

Table 3-3

Section Description	Load Delivered by Section	Section Length	Run Length	Tube Size
"A" – Trunk	221 CFH = 221,000 BTUH	45 feet	70 feet	1" CSST
"B" – Furnace	80 CFH = 80,000 BTUH	15 feet	60 feet	3/4" CSST
"C" – Water Heater	36 CFH = 36,000 BTUH	10 feet	55 feet	1/2" CSST
"D" – Range	52 CFH = 52,000 BTUH	20 feet	65 feet	3/4" CSST
"E" – Dryer/BBQ Trunk	53 CFH = 53,000 BTUH	20 feet	70 feet	3/4" CSST
"F" – Dryer	28 CFH = 28,000 BTUH	5 feet	70 feet	1/2" CSST
"G" – BBQ	25 CFH = 25,000 BTUH	5 feet	70 feet	1/2" CSST
Run Length for Trunk Sections = Distance from meter to furthest appliance (Longest Run)				
Run Length for Appliance Sections = Distance from meter to each appliance				

SIZING RUN "A"

- Run "A" is sized by the total load of all appliances and the run length from the meter to the furthest appliance
- The total load of all appliances is 80 + 36 + 52 + 28 + 25 = 221CFH
- The run length to the BBQ (furthest appliance) is 45 + 20 + 5 = 70ft
- Referring to Table 7-2 (1.0"WC pressure drop): for a 70ft run, 1" CSST has a capacity over 221CFH (actual: 227)

SIZING RUN "B"

- Run "B" is sized by the load of the supplied appliance and the run length from the meter to the supplied appliance
- The load of the furnace is 80CFH
- The run length to the furnace is 45 + 15 = 60ft
- Referring to Table 7-2 (1.0"WC pressure drop) for a 60ft run, 3/4" CSST has a capacity over 80CFH (actual: 110)

### SIZING RUN “C”

- Run “C” is sized by the load of the supplied appliance and the run length to the supplied appliance
- The load of the water heater is 36CFH
- The run length to the water heater is  $45 + 10 = 55\text{ft}$
- Referring to Table 7-2 (1.0"WC pressure drop) for a 60ft run, 1/2" CSST has a capacity over 36CFH (actual: 54)

### SIZING RUN “D”

- Run “D” is sized by the load of the supplied appliance and the run length to the supplied appliance
- The load of the range is 52CFH
- The run length to the range is  $45 + 20 = 65\text{ft}$
- Referring to Table 7-2 (1.0"WC pressure drop) for a 70ft run, 3/4" CSST has a capacity over 52CFH (actual: 103)

### SIZING RUN “E”

- Run “E” is sized by the total load of all supplied appliances and the run length from the meter to the furthest appliance
- The total load of the BBQ and the dryer is  $25 + 28 = 53\text{CFH}$
- The run length to the BBQ (furthest appliance) is  $45 + 20 + 5 = 70\text{ft}$
- Referring to Table 7-2 (1.0"WC pressure drop) for a 70ft run, 3/4" CSST has a capacity over 53CFH (actual: 103)

### SIZING RUN “F”

- Run “F” is sized by the load of the supplied appliance and the run length to the supplied appliance
- The load of the dryer is 28CFH
- The run length to the dryer is  $45 + 20 + 5 = 70\text{ft}$
- Referring to Table 7-2 (1.0"WC pressure drop) for a 70ft run, 1/2" CSST has a capacity over 28CFH (actual: 50)

### SIZING RUN “G”

- Run “G” is sized by the total load of the supplied appliance and the run length from the meter to the furthest appliance
- The load of the BBQ is 25CFH
- The run length to the BBQ is  $45 + 20 + 5 = 70\text{ft}$
- Referring to Table 7-2 (1.0"WC pressure drop) for a 70ft run, 1/2" CSST has a capacity over 25CFH (actual: 50)

3.2.4 Example 3 - Parallel System – 12-14"WC

Figure 3-11 below shows the same house and piping system as Example 2. The piping is arranged in parallel fashion, with individual CSST appliance runs supplied by a main distribution manifold. The utility company’s supply pressure (downstream of the meter) is 12-14"WC. The utility company advises that the specific gravity of the gas delivered will be 0.60 and the energy content is 1 CFH = 1000 BTUH. The allowable pressure drop across the system has been determined to be 7"WC (supply pressure 12"WC - appliance requirement 5"WC). As there is no 7"WC pressure drop chart available we must use the next lowest chart: in this case the 6"WC pressure drop chart (Table 7-8).

Fig. 3-11

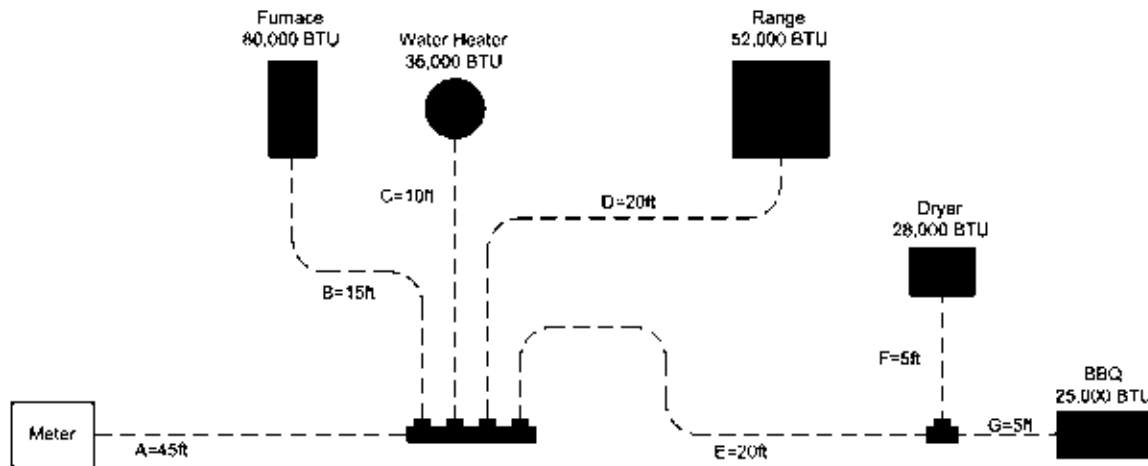

Section Description	Load Delivered by Section	Section Length	Run Length	Tube Size
"A" – Trunk	221 CFH = 221,000 BTUH	45 feet	70 feet	3/4" CSST
"B" – Furnace	80 CFH = 80,000 BTUH	15 feet	60 feet	1/2" CSST
"C" – Water Heater	36 CFH = 36,000 BTUH	10 feet	55 feet	3/8" CSST
"D" – Range	52 CFH = 52,000 BTUH	20 feet	65 feet	1/2" CSST
"E" – Dryer/BBQ Trunk	53 CFH = 53,000 BTUH	20 feet	70 feet	1/2" CSST
"F" – Dryer	28 CFH = 28,000 BTUH	5 feet	70 feet	3/8" CSST
"G" – BBQ	25 CFH = 25,000 BTUH	5 feet	70 feet	3/8" CSST
Run Length for Trunk Sections = Distance from meter to furthest appliance (Longest Run)				
Run Length for Appliance Sections = Distance from meter to each appliance				

SIZING RUN "A"

- Run "A" is sized by the total load of all appliances and the run length from the meter to the furthest appliance
- The total load of all appliances is 80 + 36 + 52 + 28 + 25 = 221CFH
- The run length to the BBQ (furthest appliance) is 45 + 20 + 5 = 70ft
- Referring to Table 7-8 (6.0"WC pressure drop) for a 70ft run, 3/4" CSST has a capacity over 221CFH (actual: 234)

SIZING RUN "B"

- Run "B" is sized by the load of the supplied appliance and the run length from the meter to the supplied appliance
- The load of the furnace is 80CFH
- The run length to the furnace is 45 + 15 = 60ft
- Referring to Table 7-8 (6.0"WC pressure drop) for a 60ft run, 1/2" CSST has a capacity over 80CFH (actual: 131)

### SIZING RUN “C”

- Run “C” is sized by the load of the supplied appliance and the run length to the supplied appliance
- The load of the water heater is 36CFH
- The run length to the water heater is  $45 + 10 = 55\text{ft}$
- Referring to Table 7-8 (6.0"WC pressure drop) for a 60ft run, 3/8" CSST has a capacity over 36CFH (actual: 47)

### SIZING RUN “D”

- Run “D” is sized by the load of the supplied appliance and the run length to the supplied appliance
- The load of the range is 52CFH
- The run length to the range is  $45 + 20 = 65\text{ft}$
- Referring to Table 7-8 (6.0"WC pressure drop) for a 70ft run, 1/2" CSST has a capacity over 52CFH (actual: 122)

### SIZING RUN “E”

- Run “E” is sized by the total load of all supplied appliances and the run length from the meter to the furthest appliance
- The total load of the BBQ and the dryer is  $25 + 28 = 53\text{CFH}$
- The run length to the BBQ (furthest appliance) is  $45 + 20 + 5 = 70\text{ft}$
- Referring to Table 7-8 (6.0"WC pressure drop) for a 70ft run, 1/2" CSST has a capacity over 53CFH (actual: 122)

### SIZING RUN “F”

- Run “F” is sized by the load of the supplied appliance and the run length to the supplied appliance
- The load of the dryer is 28CFH
- The run length to the dryer is  $45 + 20 + 5 = 70\text{ft}$
- Referring to Table 7-8 (6.0"WC pressure drop) for a 70ft run, 3/8" CSST has a capacity over 28CFH (actual: 43)

### SIZING RUN “G”

- Run “G” is sized by the total load of the supplied appliance and the run length from the meter to the furthest appliance
- The load of the BBQ is 25CFH
- The run length to the BBQ is  $45 + 20 + 5 = 70\text{ft}$
- Referring to Table 7-8 (6.0"WC pressure drop) for a 70ft run, 3/8" CSST has a capacity over 25CFH (actual: 43)



3.2.5 Example 4 - Dual Pressure System – 2 PSI Trunk and 8"WC Appliance Runs

Figure 3-12 below shows the same house and similar piping system as Example 3. The piping is arranged in parallel fashion, with individual CSST appliance runs supplied by a main distribution manifold. A regulator is mounted at the manifold. The utility company’s supply pressure (downstream of the meter) is 2psi. The utility company advises that the specific gravity of the gas delivered will be 0.60 and the energy content is 1 CFH = 1000 BTUH. The pounds-to-inches regulator is set to 8"WC. Downstream of the regulator the allowable pressure drop across the system has been determined to be 3"WC (supply pressure 8"WC - appliance requirement 5"WC). Upstream of the regulator the 2psi line pressure chart with a pressure drop of 1psi can be used. This will supply the regulator with the 1psi inlet pressure required for full capacity flow.

Fig. 3-12

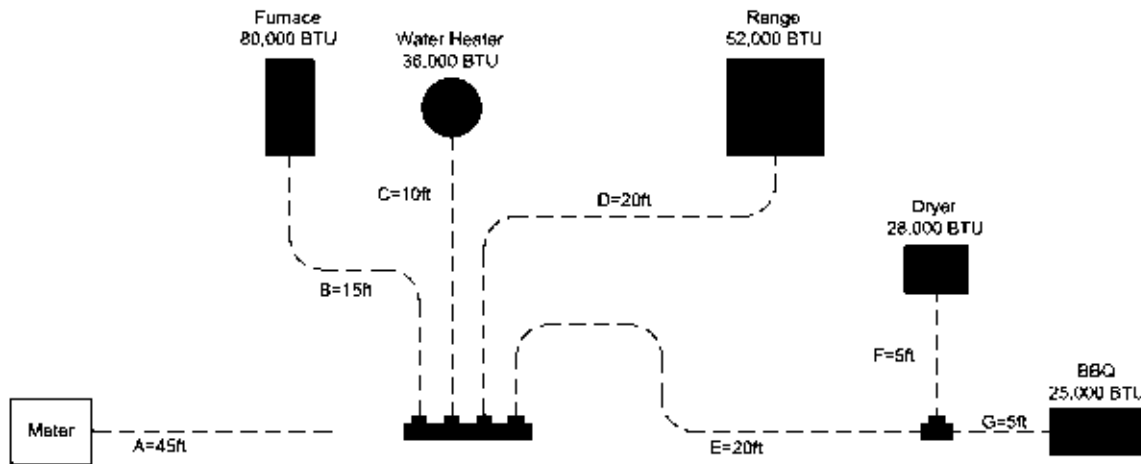

Table 3-5

Section Description	Load Delivered by Section	Section Length	Run Length	Tube Size
“A” – Trunk	221 CFH = 221,000 BTUH	45 feet	45 feet	1/2" CSST
“B” – Furnace	80 CFH = 80,000 BTUH	15 feet	15 feet	1/2" CSST
“C” – Water Heater	36 CFH = 36,000 BTUH	10 feet	10 feet	3/8" CSST
“D” – Range	52 CFH = 52,000 BTUH	20 feet	20 feet	3/8" CSST
“E” – Dryer/BBQ	53 CFH = 53,000 BTUH	20 feet	25 feet	1/2" CSST
“F” – Dryer	28 CFH = 28,000 BTUH	5 feet	25 feet	3/8" CSST
“G” – BBQ	25 CFH = 25,000 BTUH	5 feet	25 feet	3/8" CSST
Run Length for Trunk Sections = Distance from meter to regulator				
Run Length for Appliance Sections = Distance from regulator to each appliance				

SIZING RUN “A”

- Run “A” is sized by the total load of all appliances and the run length from the meter to the regulator
- The total load of all appliances is 80 + 36 + 52 + 28 + 25 = 221CFH
- The run length to the regulator is 45ft
- Referring to Table 7-10 (2psi line pressure, 1psi pressure drop) for a 45ft run, 1/2" CSST has a capacity over 221CFH (actual: 307)

SIZING RUN “B”

- Run “B” is sized by the load of the supplied appliance and the run length from the regulator to the supplied appliance
- The load of the furnace is 80CFH
- The run length to the furnace is 15ft
- Referring to Table 7-5 (3.0"WC pressure drop) for a 15ft run, 1/2" CSST has a capacity over 80CFH (actual: 185)

### SIZING RUN “C”

- Run “C” is sized by the load of the supplied appliance and the run length to the supplied appliance
- The load of the water heater is 36CFH
- The run length to the water heater is 10ft
- Referring to Table 7-5 (3.0"WC pressure drop) for a 10ft run, 3/8" CSST has a capacity over 36CFH (actual: 83)

### SIZING RUN “D”

- Run “D” is sized by the load of the supplied appliance and the run length to the supplied appliance
- The load of the range is 52CFH
- The run length to the range is 20ft
- Referring to Table 7-5 (3.0"WC pressure drop) for a 20ft run, 3/8" CSST has a capacity over 52CFH (actual: 58)

### SIZING RUN “E”

- Run “E” is sized by the total load of all supplied appliances and the run length from the regulator to the furthest appliance
- The total load of the BBQ and the dryer is  $25 + 28 = 53$ CFH
- The run length to the BBQ (furthest appliance) is  $20 + 5 = 25$ ft
- Referring to Table 7-5 (3.0"WC pressure drop) for a 25ft run, 1/2" CSST has a capacity over 53CFH (actual: 144)

### SIZING RUN “F”

- Run “F” is sized by the load of the supplied appliance and the run length to the supplied appliance
- The load of the dryer is 28CFH
- The run length to the dryer is  $20 + 5 = 25$ ft
- Referring to Table 7-5 (3.0"WC pressure drop) for a 25ft run, 3/8" CSST has a capacity over 28CFH (actual: 51)

### SIZING RUN “G”

- Run “G” is sized by the total load of the supplied appliance and the run length from the regulator to the furthest appliance
- The load of the BBQ is 25CFH
- The run length to the BBQ is  $20 + 5 = 25$ ft
- Referring to Table 7-5 (3.0"WC pressure drop) for a 25ft run, 3/8" CSST has a capacity over 25CFH (actual: 51)

### 3.2.6 Example 5 - Multiple Manifold System

Figure 3-13 below shows the same house and similar piping system as Example 4. The piping is arranged in parallel fashion, with individual CSST appliance runs supplied by two distribution manifolds. Regulators are mounted at each manifold. The utility company’s supply pressure (downstream of the meter) is 2psi. The utility company advises that the specific gravity of the gas delivered will be 0.60 and the energy content is 1 CFH = 1000 BTUH. The pounds-to-inches regulators are set to 8"WC. Downstream of the regulators the allowable pressure drop across the system has been determined to be 3"WC (supply pressure 8"WC – appliance requirement 5"WC). Upstream of the regulators the 2psi line pressure chart with a pressure drop of 1psi can be used. This will supply the regulators with the 1psi inlet pressure required for full capacity flow.

Sizing of all appliance runs downstream from the pressure regulators is performed considering the length and load for each appliance as in the previous example.

To size the elevated pressure trunk lines, use the Longest Run Method to determine the trunk line sizes by adding the distance from the meter to the furthest regulator (trunk “A” + trunk “E”). This length is used to size both trunk lines. It important to note that the total load of the system is passing through trunk “A” while only the load of the second manifold system is passing through trunk “E”.

Fig. 3-13

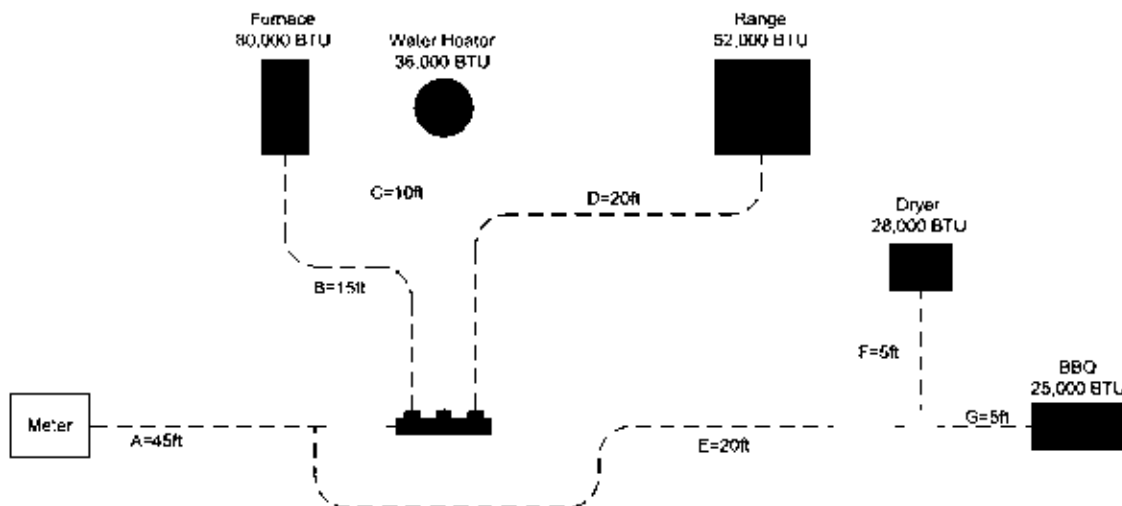

Table 3-6

Section Description	Load Delivered by Section	Section Length	Run Length	Tube Size
“A” – Trunk	221 CFH = 221,000 BTUH	45 feet	65 feet	1/2" CSST
“E” – Trunk	53 CFH = 53,000 BTUH	20 feet	65 feet	3/8" CSST
Longest Run for Trunk Section = Distance from meter to furthest regulator.				
Appliance runs are determined using the length and load for each section only.				

#### SIZING RUN “A”

- Run “A” is sized by the load of all appliances and the run length from the meter to the farthest regulator
- The total load of all appliances is 80 + 36 + 52 + 28 + 25 = 221CFH
- The run length to the farthest regulator is 45 + 20 = 65ft
- Referring to Table 7-10 (2psi with a 1psi drop): for a 70-ft run, 1/2" CSST has a capacity over 221CFH (260 actual)

### SIZING RUN "E"

- Run "E" is sized by the load of all supplied appliances and the run length from the meter to the farthest regulator
- The total load of all appliances is  $28 + 25 = 53\text{CFH}$
- The run length to the farthest regulator is  $45 + 20 = 65\text{ft}$
- Referring to Table 7-10 (2psi with a 1psi drop): for a 70-ft run, 3/8" CSST has a capacity over 53CFH (97 actual)

NOTE: Gastite® recommends that trunk lines be 1/2" minimum. Therefore, this trunk run should be upsized to 1/2".

3.2.7 Example 6 - Series System – 7"WC - Hybrid

Figure 3-14 below shows a typical single-family house retrofit installation with five (5) appliances, 2 of which are added onto an existing black pipe system. The piping is arranged in series with a main run branching at the appliances. The utility company's supply pressure (downstream of the meter) is 7"WC. The utility company advises that the specific gravity of the gas delivered will be 0.60 and the energy content is 1 CFH = 1000 BTUH. The allowable pressure drop across the system has been determined to be 2.0"WC (supply pressure 7"WC - appliance requirement 5"WC).

Fig. 3-14

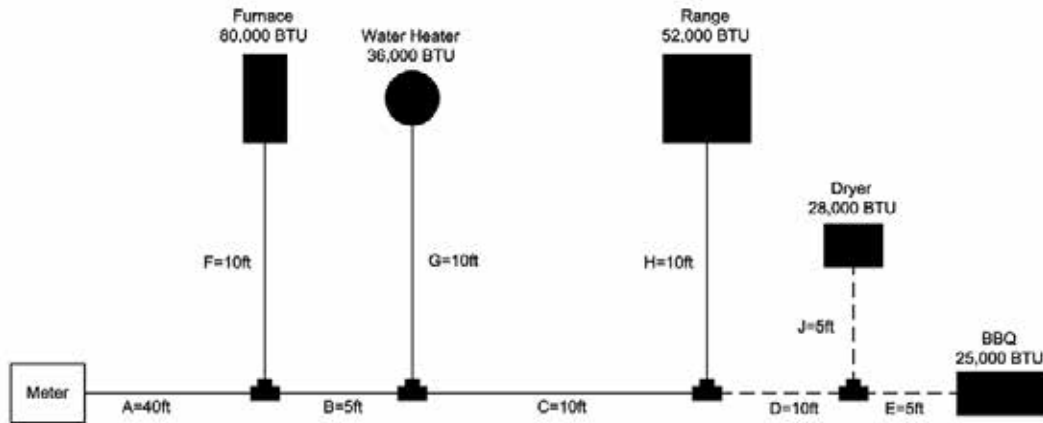

Note: Rigid pipe sized using a 0.5"WC pressure drop table, as no 2.0"WD pressure drop table for Rigid pipe is available.

Section Description	Load Delivered by Section	Section Length	Run Length	Tube Size
"A" – Rigid Trunk	221 CFH = 221,000 BTUH	40 feet	70 feet	1" Rigid
"B" – Rigid Trunk	141 CFH = 140,000 BTUH	5 feet	70 feet	1" Rigid
"C" – Rigid Trunk	105 CFH = 105,000 BTUH	10 feet	70 feet	3/4" Rigid
"D" – CSST Trunk	53 CFH = 53,000 BTUH	10 feet	70 feet	1/2" CSST
"E" – BBQ	25 CFH = 25,000 BTUH	5 feet	70 feet	1/2" CSST
"F" – Furnace	80 CFH = 80,000 BTUH	10 feet	50 feet	3/4" Rigid
"G" – Water Heater	36 CFH = 36,000 BTUH	10 feet	55 feet	3/8" Rigid
"H" – Range	52 CFH = 52,000 BTUH	10 feet	65 feet	1/2" Rigid
"J" – Dryer	28 CFH = 28,000 BTUH	5 feet	70 feet	1/2" CSST
Run Length for Trunk Sections = Distance from meter to furthest appliance (Longest Run)				
Run Length for Appliance Sections = Distance from meter to each appliance				

SIZING RUN "A"

- Run "A" is sized by the total load of all appliances and the run length from the meter to the furthest appliance
- The total load of all appliances is 80 + 36 + 52 + 28 + 25 = 221CFH
- The run length to the BBQ (furthest appliance) is 40 + 5 + 10 + 10 + 5 = 70ft
- Referring to Table 7-23 (Rigid pipe 0.5"WC pressure drop): for a 70ft run, 1" Rigid pipe has a capacity over 221CFH (actual: 240)

SIZING RUN "B"

- Run "B" is sized by the total load of all supplied appliances and the run length from the meter to the furthest appliance
- The total load of the supplied appliances is 36 + 52 + 28 + 25 = 141CFH
- The run length to the BBQ (furthest appliance) is 40 + 5 + 10 + 10 + 5 = 70ft
- Referring to Table 7-23 (Rigid pipe 0.5"WC pressure drop) for a 70ft run, 1" Rigid pipe has a capacity over 141CFH (actual: 240)

**SIZING RUN "C"**

- Run "C" is sized by the total load of all supplied appliances and the run length from the meter to the furthest appliance
- The total load of all appliances is  $52 + 28 + 25 = 105\text{CFH}$
- The run length to the BBQ (furthest appliance) is  $40 + 5 + 10 + 10 + 5 = 70\text{ft}$
- Referring to Table 7-23 (Rigid pipe 0.5"WC pressure drop): for a 70ft run, 3/4" Rigid pipe has a capacity over 105CFH (actual: 125)

**SIZING RUN "D"**

- Run "D" is sized by the total load of all supplied appliances and the run length from the meter to the furthest appliance
- The total load of the BBQ and the dryer is  $25 + 28 = 53\text{CFH}$
- The run length to the BBQ (furthest appliance) is  $40 + 5 + 10 + 10 + 5 = 70\text{ft}$
- Referring to Table 7-4 (2.0"WC pressure drop) for a 70ft run, 1/2" CSST has a capacity over 53CFH (actual: 71)

**SIZING RUN "E"**

- Run "E" is sized by the total load of the supplied appliance and the run length from the meter to the furthest appliance
- The load of the BBQ is 25CFH
- The run length to the BBQ is  $40 + 5 + 10 + 10 + 5 = 70\text{ft}$
- Referring to Table 7-4 (2.0"WC pressure drop) for a 70ft run, 1/2" CSST has a capacity over 25CFH (actual: 71)

**SIZING RUN "F"**

- Run "F" is sized by the load of the supplied appliance and the run length from the meter to the supplied appliance
- The load of the furnace is 80CFH
- The run length to the furnace is  $40 + 10 = 50\text{ft}$
- Referring to Table 7-23 (Rigid pipe 0.5"WC pressure drop) for a 50ft run, 3/4" Rigid pipe has a capacity over 80CFH (actual: 151)

**SIZING RUN "G"**

- Run "G" is sized by the load of the supplied appliance and the run length to the supplied appliance
- The load of the water heater is 36CFH
- The run length to the water heater is  $40 + 5 + 10 = 55\text{ft}$
- Referring to Table 7-23 (Rigid pipe 0.5"WC pressure drop) for a 60ft run, 3/8" Rigid pipe has a capacity over 36CFH (actual: 36)

**SIZING RUN "H"**

- Run "H" is sized by the load of the supplied appliance and the run length to the supplied appliance
- The load of the range is 52CFH
- The run length to the range is  $40 + 5 + 10 + 10 = 65\text{ft}$
- Referring to Table 7-23 (Rigid pipe 0.5"WC pressure drop) for a 70ft run, 1/2" Rigid pipe has a capacity over 52CFH (actual: 61)

**SIZING RUN "J"**

- Run "J" is sized by the load of the supplied appliance and the run length to the supplied appliance
- The load of the dryer is 28CFH
- The run length to the dryer is  $40 + 5 + 10 + 10 + 5 = 70\text{ft}$
- Referring to Table 7-4 (2.0"WC pressure drop) for a 70ft run, 1/2" CSST has a capacity over 28CFH (actual: 71)



3.2.8 Example 7 - Parallel System – 7"WC – Hybrid

Figure 3-15 below shows the same house and similar piping system as Example 2. The piping is arranged in parallel fashion, with individual CSST appliance runs supplied by a main distribution manifold. The main trunk line (“A”) from the meter to the distribution manifold is rigid pipe rather than CSST. The utility company’s supply pressure (downstream of the meter) is 7"WC. The utility company advises that the specific gravity of the gas delivered will be 0.60 and the energy content is 1 CFH = 1000 BTUH.

The allowable pressure drop across the system has been determined to be 2"WC (supply pressure 7"WC - appliance requirement 5"WC). 0.5"WC pressure drop will be taken over the rigid pipe trunk line and the remaining appliance runs.

Fig. 3-15

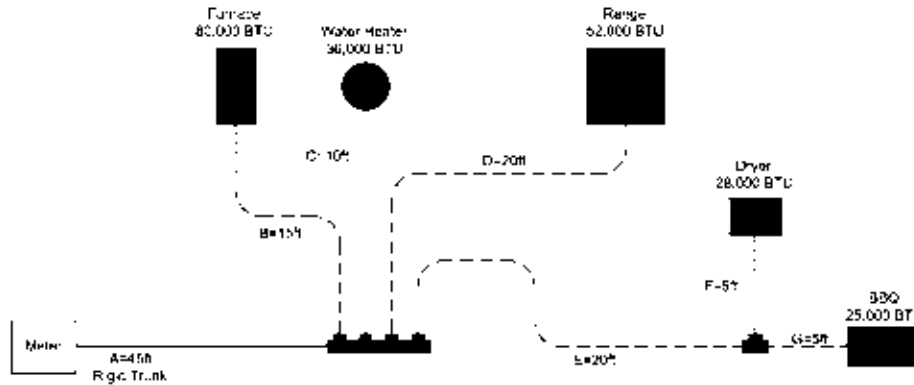

Note: Rigid pipe sized using a 0.5"WC pressure drop table, as no 2.0"WD pressure drop table for Rigid pipe is available.

Section Description	Load Delivered by Section	Section Length	Run Length	Tube Size
"A" – Rigid Trunk	221 CFH = 221,000 BTUH	45 feet	70feet	1" Rigid
"B" – Furnace	80 CFH = 80,000 BTUH	15 feet	60 feet	3/4" CSST
"C" – Water Heater	36 CFH = 36,000 BTUH	10 feet	55 feet	1/2" CSST
"D" – Range	52 CFH = 52,000 BTUH	20 feet	65 feet	1/2" CSST
"E" – Dryer/BBQ Trunk	53 CFH = 53,000 BTUH	20 feet	70 feet	1/2" CSST
"F" – Dryer	28 CFH = 28,000 BTUH	5 feet	70 feet	1/2" CSST
"G" – BBQ	25 CFH = 25,000 BTUH	5 feet	70 feet	1/2" CSST
Run Length for Trunk Sections = Distance from meter to furthest appliance (Longest Run)				
Run Length for Appliance Sections = Distance from meter to each appliance				

SIZING RUN "A"

- Run "A" is sized by the total load of all appliances and the run length from the meter to the furthest appliance
- The total load of all appliances is 80 + 36 + 52 + 28 + 25 = 221CFH
- The run length to the BBQ (furthest appliance) is 45 + 20 + 5 = 70ft
- Referring to Table 7-23 (Rigid pipe 0.5"WC pressure drop): for a 70ft run, 1" pipe has a capacity over 221CFH (actual: 240)

SIZING RUN "B"

- Run "B" is sized by the load of the supplied appliance and the run length from the meter to the supplied appliance
- The load of the furnace is 80CFH
- The run length to the furnace is 45 + 15 = 60ft
- Referring to Table 7-4 (2.0"WC pressure drop) for a 60ft run, 3/4" CSST has a capacity over 80CFH (actual: 152)

### SIZING RUN “C”

- Run “C” is sized by the load of the supplied appliance and the run length from the meter to the supplied appliance
- The load of the water heater is 36CFH
- The run length to the water heater is  $45 + 10 = 55\text{ft}$
- Referring to Table 7-4 (2.0"WC pressure drop) for a 60ft run, 1/2" CSST has a capacity over 36CFH (actual: 76)

### SIZING RUN “D”

- Run “D” is sized by the load of the supplied appliance and the run length from the meter to the supplied appliance
- The load of the range is 52CFH
- The run length to the range is  $45 + 20 = 65\text{ft}$
- Referring to Table 7-4 (2.0"WC pressure drop) for a 70ft run, 1/2" CSST has a capacity over 52CFH (actual: 71)

### SIZING RUN “E”

- Run “E” is sized by the total load of all supplied appliances and the run length from the meter to the furthest appliance
- The total load of the BBQ and the dryer is  $25 + 28 = 53\text{CFH}$
- The run length to the BBQ (furthest appliance) is  $45 + 20 + 5 = 70\text{ft}$
- Referring to Table 7-4 (2.0"WC pressure drop) for a 70ft run, 1/2" CSST has a capacity over 53CFH (actual: 71)

### SIZING RUN “F”

- Run “F” is sized by the load of the supplied appliance and the run length from the meter to the supplied appliance
- The load of the dryer is 28CFH
- The run length to the dryer is  $45 + 20 + 5 = 70\text{ft}$
- Referring to Table 7-4 (2.0"WC pressure drop) for a 70ft run, 1/2" CSST has a capacity over 28CFH (actual: 71)

### SIZING RUN “G”

- Run “G” is sized by the total load of the supplied appliance and the run length from the meter to the furthest appliance
- The load of the BBQ is 25CFH
- The run length to the BBQ is  $45 + 20 + 5 = 70\text{ft}$
- Referring to Table 7-4 (2.0"WC pressure drop) for a 70ft run, 1/2" CSST has a capacity over 25CFH (actual: 71)

3.2.9 Example 8 - Summation Method for Parallel System – 7"WC – Hybrid

Figure 3-16 below shows the same house as Example 6. The piping is arranged in parallel fashion, with individual CSST appliance runs supplied by a main distribution manifold. The main trunk line ("A") from the meter to the distribution manifold is rigid pipe rather than CSST. The utility company's supply pressure (downstream of the meter) is 7"WC. The utility company advises that the specific gravity of the gas delivered will be 0.60 and the energy content is 1 CFH = 1000 BTUH. The allowable pressure drop across the system has been determined to be 2.0"WC (supply pressure 7"WC - appliance requirement 5"WC).

When using the "Summation Method" for gas pipe sizing, the sum of the pressure losses through each section of pipe should result in a minimum 5"WC pressure delivered to the appliance inlet. (Pressures less than 5"WC may be sufficient for proper appliance operation but should be reviewed with the manufacturer's input rating and the local administrative authority).

Fig. 3-16

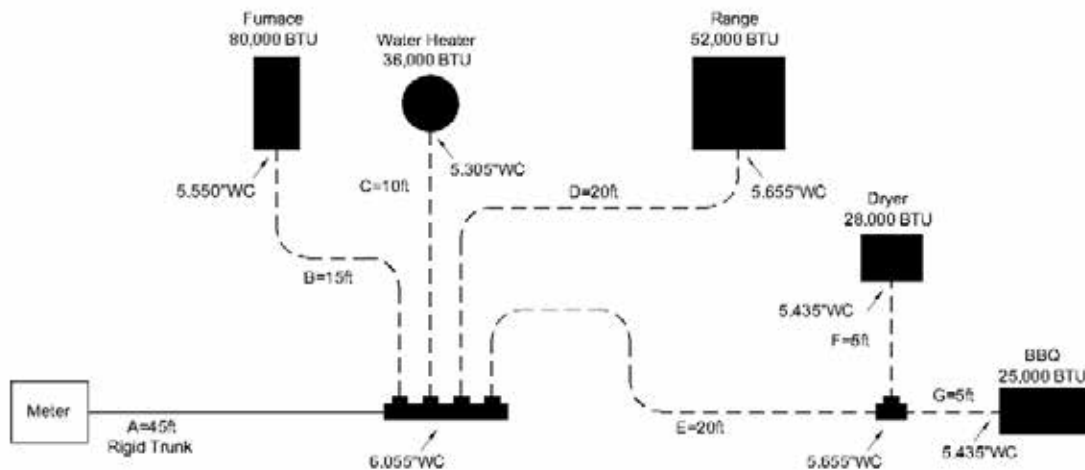

Section Description	Load Delivered by Section	Section Length	Tube Size
"A" – Rigid Trunk	221 CFH = 221,000 BTUH	45 feet	3/4" Rigid
"B" – Furnace	80 CFH = 80,000 BTUH	15 feet	1/2" CSST
"C" – Water Heater	36 CFH = 36,000 BTUH	10 feet	3/8" CSST
"D" – Range	52 CFH = 52,000 BTUH	20 feet	1/2" CSST
"E" – Dryer/BBQ Trunk	53 CFH = 53,000 BTUH	20 feet	1/2" CSST
"F" – Dryer	28 CFH = 28,000 BTUH	5 feet	3/8" CSST
"G" – BBQ	25 CFH = 25,000 BTUH	5 feet	3/8" CSST

SIZING RUN "A"

- Run "A" is sized by the total load of all appliances and the section length
- The total load of all appliances is 80 + 36 + 52 + 28 + 25 = 221CFH
- The section length is 45ft
- Referring to Table 7-24 (Pressure drop per foot for Rigid Pipe): for a 225CFH load, 3/4" pipe has a drop of 0.021"WC per ft
- The pressure drop over Run "A" is: 0.021" x 45ft = 0.945"WC
- The available pressure at the end of run "A" is 7"WC - 0.945"WC = 6.055"WC

**SIZING RUN “B”**

- Run “B” is sized by the load of the supplied appliance and the section length
- The load of the furnace is 80CFH
- The section length to the furnace is 15ft
- Referring to Table 7-21 (Pressure drop per foot for Gastite® CSST): for a 80CFH load, 1/2" CSST has a drop of 0.037"WC / ft
- The pressure drop over Run “B” is:  $0.037" \times 15\text{ft} = 0.555"WC$
- The available pressure at the end of run “B” is  $6.055"WC - 0.555"WC = 5.500"WC$

**SIZING RUN “C”**

- Run “C” is sized by the load of the supplied appliance and the section length
- The load of the water heater is 36CFH
- The section length is 10ft
- Referring to Table 7-21 (Pressure drop per foot for Gastite® CSST): for a 40CFH load, 3/8" CSST has a drop of 0.075"WC / ft
- The pressure drop over Run “C” is:  $0.075" \times 10\text{ft} = 0.750"WC$
- The available pressure at the end of run “C” is  $6.055"WC - 0.750"WC = 5.305"WC$

**SIZING RUN “D”**

- Run “D” is sized by the load of the supplied appliance and the section length
- The load of the range is 52CFH
- The section length is 20ft
- Referring to Table 7-21 (Pressure drop per foot for Gastite® CSST): for a 60CFH load, 1/2" CSST has a drop of 0.020"WC / ft
- The pressure drop over Run “D” is:  $0.020" \times 20\text{ft} = 0.400"WC$
- The available pressure at the end of run “D” is  $6.055"WC - 0.400"WC = 5.655"WC$

**SIZING RUN “E”**

- Run “E” is sized by the total load of all supplied appliances and the section length
- The total load of the BBQ and the dryer is  $25 + 28 = 53CFH$
- The section length is 20ft
- Referring to Table 7-21 (Pressure drop per foot for Gastite® CSST): for a 60CFH load, 1/2" CSST has a drop of 0.020"WC / ft
- The pressure drop over Run “E” is:  $0.020" \times 20\text{ft} = 0.400"WC$
- The available pressure at the end of run “E” is  $6.055"WC - 0.400"WC = 5.655"WC$

**SIZING RUN “F”**

- Run “F” is sized by the load of the supplied appliance and the section length
- The load of the dryer is 28CFH
- The section length 5ft
- Referring to Table 7-21 (Pressure drop per foot for Gastite® CSST): for a 30CFH load, 3/8" CSST has a drop of 0.044"WC / ft
- The pressure drop over Run “F” is:  $0.044" \times 5\text{ft} = 0.220"WC$
- The available pressure at the end of run “F” is  $5.655"WC - 0.220"WC = 5.435"WC$

**SIZING RUN “G”**

- Run “G” is sized by the total load of the supplied appliance and the section length
- The load of the BBQ is 25CFH
- The section length 5ft
- Referring to Table 7-21 (Pressure drop per foot for Gastite® CSST): for a 30CFH load, 3/8" CSST has a drop of 0.044"WC / ft
- The pressure drop over Run “G” is:  $0.044" \times 5\text{ft} = 0.220"WC$
- The available pressure at the end of run “G” is  $5.655"WC - 0.220"WC = 5.435"WC$

3.2.10 Example 9: Summation Method for Series System – 6"WC

Figure 3-17 below shows the same house and piping system as Example 1. The piping is arranged in series with a main run branching at the appliances. The utility company’s supply pressure (downstream of the meter) is 6"WC. The utility company advises that the specific gravity of the gas delivered will be 0.60 and the energy content is 1 CFH = 1000 BTUH. The allowable pressure drop across the system has been determined to be 1.0"WC (supply pressure 6"WC - appliance requirement 5"WC).

When using the “Summation Method” for gas pipe sizing, the sum of the pressure losses through each section of pipe should result in a minimum 5"WC pressure delivered to the appliance inlet. (Pressures less than 5"WC may be sufficient for proper appliance operation but should be reviewed with the manufacturer’s input rating and the local administrative authority).

Fig. 3-17

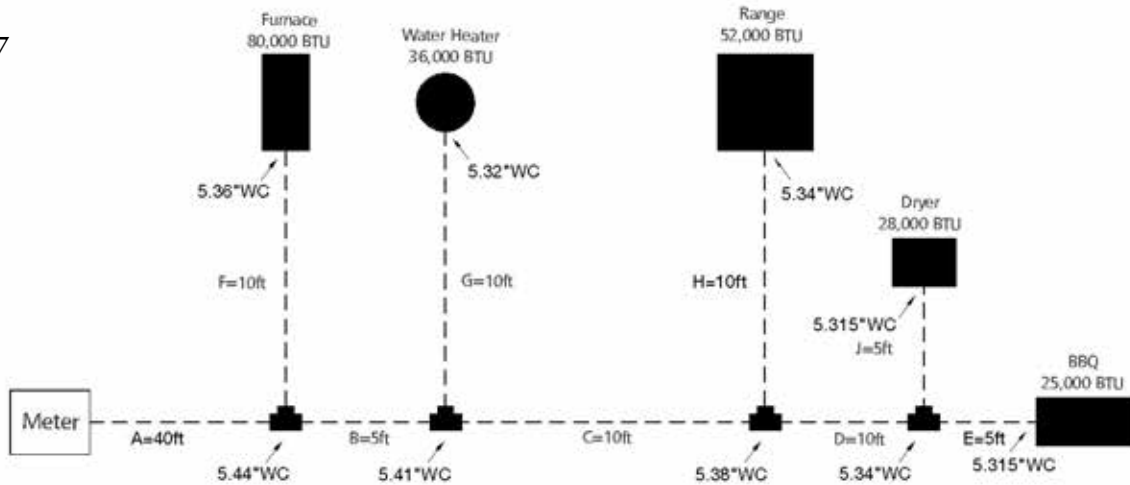

Section Description	Load Delivered by Section	Section Length	Tube Size
“A” – Trunk	221 CFH = 221,000 BTUH	40 feet	1" CSST
“B” – Trunk	141 CFH = 141,000 BTUH	5 feet	1" CSST
“C” – Trunk	105 CFH = 105,000 BTUH	10 feet	1" CSST
“D” – Trunk	53 CFH = 53,000 BTUH	10 feet	3/4" CSST
“E” – BBQ	25 CFH = 25,000 BTUH	5 feet	1/2" CSST
“F” – Furnace	80 CFH = 80,000 BTUH	10 feet	3/4" CSST
“G” – Water Heater	36 CFH = 36,000 BTUH	10 feet	1/2" CSST
“H” – Range	52 CFH = 52,000 BTUH	10 feet	3/4" CSST
“J” – Dryer	28 CFH = 28,000 BTUH	5 feet	1/2" CSST

SIZING RUN “A”

- Run “A” is sized by the total load of all appliances and the section length
- The total load of all appliances is 80 + 36 + 52 + 28 + 25 = 221CFH
- The section length is 40ft
- Referring to Table 7-21 (Pressure drop per foot for Gastite® CSST): for a 225CFH load, 1" CSST has a drop of 0.014"WC per ft. The pressure drop over Run “A” is: 0.014" x 40ft = 0.560"WC
- The available pressure at the end of run “A” is 6"WC - 0.560"WC = 5.440"WC

### SIZING RUN "B"

- Run "B" is sized by the total load of all supplied appliances and the section length
- The total load of the supplied appliances is  $36 + 52 + 28 + 25 = 141\text{CFH}$
- The section length is 5ft
- Referring to Table 7-21 (Pressure drop per foot for Gastite® CSST): for a 150CFH load, 1" CSST has a drop of  $0.006''\text{WC} / \text{ft}$
- The pressure drop over Run "B" is:  $0.006'' \times 5\text{ft} = 0.030''\text{WC}$
- The available pressure at the end of run "B" is  $5.440''\text{WC} - 0.030''\text{WC} = 5.410''\text{WC}$

### SIZING RUN "C"

- Run "C" is sized by the total load of all supplied appliances and the section length
- The total load of the supplied appliances is  $52 + 28 + 25 = 105\text{CFH}$
- The section length is 10ft
- Referring to Table 7-21 (Pressure drop per foot for Gastite® CSST): for a 110CFH load, 1" CSST has a drop of  $0.003''\text{WC} / \text{ft}$
- The pressure drop over Run "C" is:  $0.003'' \times 10\text{ft} = 0.030''\text{WC}$
- The available pressure at the end of run "C" is  $5.410''\text{WC} - 0.030''\text{WC} = 5.380''\text{WC}$

### SIZING RUN "D"

- Run "D" is sized by the total load of all supplied appliances and the section length
- The total load of the BBQ and the dryer is  $25 + 28 = 53\text{CFH}$
- The section length 10ft
- Referring to Table 7-21 (Pressure drop per foot for Gastite® CSST): for a 60CFH load, 3/4" CSST has a drop of  $0.004''\text{WC} / \text{ft}$
- The pressure drop over Run "D" is:  $0.004'' \times 10\text{ft} = 0.040''\text{WC}$
- The available pressure at the end of run "D" is  $5.380''\text{WC} - 0.040''\text{WC} = 5.340''\text{WC}$

### SIZING RUN "E"

- Run "E" is sized by the load of the supplied appliance and the section length
- The load of the BBQ is 25CFH
- The section length is 5ft
- Referring to Table 7-21 (Pressure drop per foot for Gastite® CSST): for a 30CFH load, 1/2" CSST has a drop of  $0.005''\text{WC} / \text{ft}$
- The pressure drop over Run "E" is:  $0.005'' \times 5\text{ft} = 0.025''\text{WC}$
- The available pressure at the end of run "E" is  $5.340''\text{WC} - 0.025''\text{WC} = 5.315''\text{WC}$

### SIZING RUN "F"

- Run "F" is sized by the load of the supplied appliance and the section length
- The load of the furnace is 80CFH
- The section length to the furnace is 10ft
- Referring to Table 7-21 (Pressure drop per foot for Gastite® CSST): for a 80CFH load, 3/4" CSST has a drop of  $0.008''\text{WC} / \text{ft}$
- The pressure drop over Run "F" is:  $0.008'' \times 10\text{ft} = 0.080''\text{WC}$
- The available pressure at the end of run "F" is  $5.440''\text{WC} - 0.080''\text{WC} = 5.360''\text{WC}$

### SIZING RUN "G"

- Run "G" is sized by the load of the supplied appliance and the section length
- The load of the water heater is 36CFH
- The section length to the water heater is 10ft
- Referring to Table 7-21 (Pressure drop per foot for Gastite® CSST): for a 40CFH load, 1/2" CSST has a drop of  $0.009''\text{WC} / \text{ft}$
- The pressure drop over Run "G" is:  $0.009'' \times 10\text{ft} = 0.090''\text{WC}$
- The available pressure at the end of run "G" is  $5.410''\text{WC} - 0.090''\text{WC} = 5.320''\text{WC}$



### 3.2.10 Example 9: Summation Method for Series System – 6"WC (Continued)

#### SIZING RUN "H"

- Run "H" is sized by the load of the supplied appliance and the section length
- The load of the range is 52CFH
- The section length to the range is 10ft
- Referring to Table 7-21 (Pressure drop per foot for Gastite® CSST): for a 60CFH load, 3/4" CSST has a drop of 0.004"WC / ft
- The pressure drop over Run "H" is:  $0.004" \times 10\text{ft} = 0.040"WC$
- The available pressure at the end of run "H" is  $5.380"WC - 0.040"WC = 5.340"WC$

#### SIZING RUN "J"

- Run "J" is sized by the load of the supplied appliance and the section length
- The load of the dryer is 28CFH
- The section length to the dryer is 5ft
- Referring to Table 7-21 (Pressure drop per foot for Gastite® CSST): for a 30CFH load, 1/2" CSST has a drop of 0.005"WC / ft
- The pressure drop over Run "J" is:  $0.005" \times 5\text{ft} = 0.025"WC$
- The available pressure at the end of run "J" is  $5.340"WC - 0.025"WC = 5.315"WC$

3.2.11 Example 10 - Commercial Elevated Pressure Series System – 2PSI

Figure 3-18 below shows a typical commercial rooftop installation with four (4) appliances. The piping is arranged in series with a main run branching at the appliances. The utility company’s supply pressure (downstream of the meter) is 2psi. The utility company advises that the specific gravity of the gas delivered will be 0.60 and the energy content is 1 CFH = 1000 BTUH. The 2psi line pressure chart with a pressure drop of 1psi can be used. This will supply the regulators with the 1psi inlet pressure required for full capacity flow.

Fig. 3-17

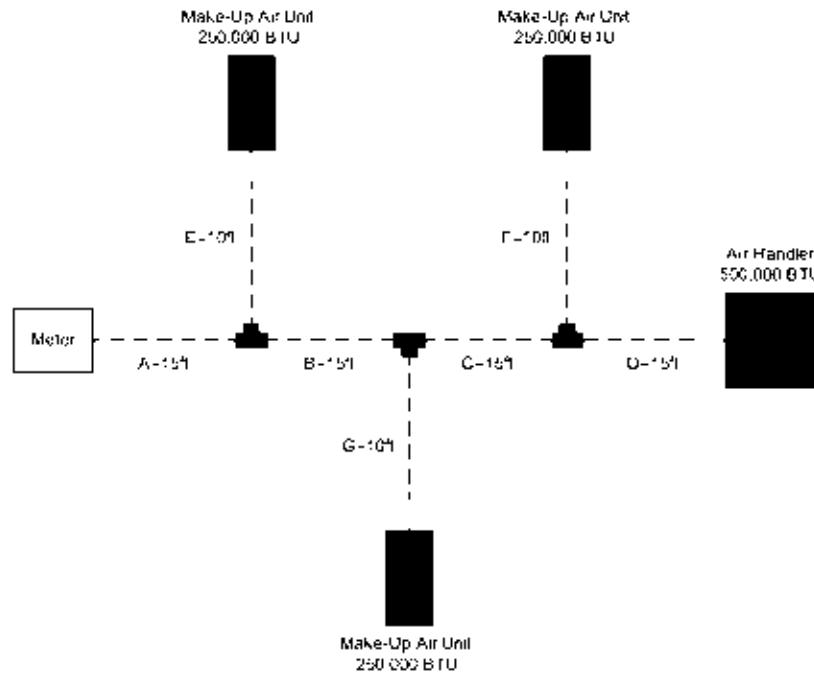

Table 3-11

Section Description	Load Delivered by Section	Section Length	Run Length	Tube Size
“A” – Trunk	1250 CFH = 1,250,000 BTUH	15 feet	60 feet	1-1/4" CSST
“B” – Trunk	1000 CFH = 1,000,000 BTUH	15 feet	60 feet	1" CSST
“C” – Trunk	750 CFH = 750,000 BTUH	15 feet	60 feet	1" CSST
“D” – Air Handler	500 CFH = 500,000 BTUH	15 feet	60 feet	3/4" CSST
“E” – Make-Up Air Unit	250 CFH = 250,000 BTUH	10 feet	25 feet	1/2" CSST
“F” – Make-Up Air Unit	250 CFH = 250,000 BTUH	10 feet	55 feet	1/2" CSST
“G” – Make-Up Air Unit	250 CFH = 250,000 BTUH	10 feet	40 feet	1/2" CSST

Run Length for Trunk Sections = Distance from meter to furthest appliance (Longest Run)

Run Length for Appliance Sections = Distance from meter to each appliance

SIZING RUN “A”

- Run “A” is sized by the total load of all appliances and the run length from the meter to the furthest appliance
- The total load of all appliances is 250 + 250 + 250 + 500 = 1250CFH
- The run length to the Air Handler (furthest appliance) is 15 + 15 + 15 + 15 = 60ft
- Referring to Table 7-10 (2psi line pressure, 1psi pressure drop): for a 60ft run, 1-1/4" CSST has a capacity over 1250CFH (actual: 1854)

### SIZING RUN “B”

- Run “B” is sized by the total load of all supplied appliances and the run length from the meter to the furthest appliance
- The total load of the supplied appliances is  $250 + 250 + 500 = 1000\text{CFH}$
- The run length to the Air Handler (furthest appliance) is  $15 + 15 + 15 + 15 = 60\text{ft}$
- Referring to Table 7-10 (2psi line pressure, 1psi pressure drop): for a 60ft run, 1" CSST has a capacity over 1000CFH (actual: 1213)

### SIZING RUN “C”

- Run “C” is sized by the total load of all supplied appliances and the run length from the meter to the furthest appliance
- The total load of all appliances is  $250 + 500 = 750\text{CFH}$
- The run length to the Air Handler (furthest appliance) is  $15 + 15 + 15 + 15 = 60\text{ft}$
- Referring to Table 7-10 (2psi line pressure, 1psi pressure drop): for a 60ft run, 1" CSST has a capacity over 750CFH (actual: 1213)

### SIZING RUN “D”

- Run “D” is sized by the total load of all supplied appliances and the run length from the meter to the furthest appliance
- The load of the Air Handler is 500CFH
- The run length to the Air Handler (furthest appliance) is  $15 + 15 + 15 + 15 = 60\text{ft}$
- Referring to Table 7-10 (2psi line pressure, 1psi pressure drop): for a 60ft run, 3/4" CSST has a capacity over 500CFH (actual: 510)

### SIZING RUN “E”

- Run “E” is sized by the total load of the supplied appliance and the run length from the meter to the supplied appliance
- The load of the Make-Up Air Unit is 250CFH
- The run length to the Make-Up Air Unit is  $15 + 10 = 25\text{ft}$
- Referring to Table 7-10 (2psi line pressure, 1psi pressure drop): for a 25ft run, 1/2" CSST has a capacity over 250CFH (actual: 432)

### SIZING RUN “F”

- Run “F” is sized by the load of the supplied appliance and the run length from the meter to the supplied appliance
- The load of the Make-Up Air Unit is 250CFH
- The run length to the Make-Up Air Unit is  $15 + 15 + 15 + 10 = 55\text{ft}$
- Referring to Table 7-10 (2psi line pressure, 1psi pressure drop): for a 60ft run, 1/2" CSST has a capacity over 250CFH (actual: 281)

### SIZING RUN “G”

- Run “G” is sized by the load of the supplied appliance and the run length from the meter to the supplied appliance
- The load of the Make-Up Air Unit is 250CFH
- The run length to the Make-Up Air Unit is  $15 + 15 + 10 = 40\text{ft}$
- Referring to Table 7-10 (2psi line pressure, 1psi pressure drop): for a 40ft run, 1/2" CSST has a capacity over 250CFH (actual: 343)

3.2.12 Example 11 - Commercial Hybrid System – 7"WC

Figure 3-19 below shows a multi-level apartment building. The piping is arranged in vertical parallel fashion, with individual CSST appliance runs supplied by distribution manifolds. The main trunk line (“A”-“D”) from the meter to the distribution manifolds is rigid pipe rather than CSST. The utility company’s supply pressure (downstream of the meter) is 7"WC. The utility company advises that the specific gravity of the gas delivered will be 0.60 and the energy content is 1 CFH = 1000 BTUH. The allowable pressure drop across the system has been determined to be 2"WC (supply pressure 7"WC – appliance requirement 5"WC). *Note: Rigid pipe sized using a 0.5"WC pressure drop table as no 2.0"WC pressure drop table for rigid pipe is available.*

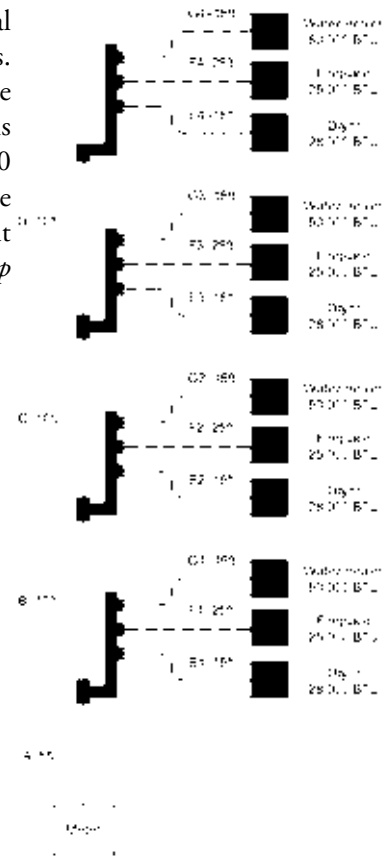

Fig. 3-19

Table 3-12				
Section Description	Load Delivered by Section	Section Length	Run Length	Tube Size
“A” – Rigid Trunk	412 CFH = 412,000 BTUH	5 feet	60 feet	1-1/4" Rigid
“B” – Rigid Trunk	309 CFH = 309,000 BTUH	10 feet	60 feet	1-1/4" Rigid
“C” – Rigid Trunk	206 CFH = 206,000 BTUH	10 feet	60 feet	1" Rigid
“D” – Rigid Trunk	103 CFH = 103,000 BTUH	10 feet	60 feet	3/4" Rigid
“E1” – Dryer	28 CFH = 28,000 BTUH	20 feet	20 feet	3/8" CSST
“F1” – Fireplace	25 CFH = 25,000 BTUH	25 feet	30 feet	1/2" CSST
“G1” – Water Heater	50 CFH = 50,000 BTUH	15 feet	20 feet	1/2" CSST
“E2” – Dryer	28 CFH = 28,000 BTUH	15 feet	30 feet	3/8" CSST
“F2” – Fireplace	25 CFH = 25,000 BTUH	25 feet	40 feet	1/2" CSST
“G2” – Water Heater	50 CFH = 50,000 BTUH	15 feet	30 feet	1/2" CSST
“E3” – Dryer	28 CFH = 28,000 BTUH	15 feet	40 feet	3/8" CSST
“F3” – Fireplace	25 CFH = 25,000 BTUH	25 feet	50 feet	1/2" CSST
“G3” – Water Heater	50 CFH = 50,000 BTUH	15 feet	40 feet	1/2" CSST
“E4” – Dryer	28 CFH = 28,000 BTUH	15 feet	50 feet	3/8" CSST
“F4” – Fireplace	25 CFH = 25,000 BTUH	25 feet	60 feet	1/2" CSST
“G4” – Water Heater	50 CFH = 50,000 BTUH	15 feet	50 feet	1/2" CSST
Run Length for Trunk Sections = Distance from meter to furthest appliance (Longest Run)				
Run Length for Appliance Sections = Distance from meter to each appliance				

SIZING RUN “A”

- Run “A” is sized by the total load of all appliances and the run length from the meter to the furthest appliance
- The total load of all appliances is 4 x (50 + 25 + 28) = 412CFH
- The run length to the 4th floor Fireplace (furthest appliance) is 5 + 10 + 10 + 10 + 25 = 60ft
- Referring to Table 7-23 (Rigid pipe 0.5"WC pressure drop): for a 60ft run, 1-1/4" pipe has a capacity over 412CF(actual: 530)

SIZING RUN “B”

- Run “B” is sized by the load of the supplied appliances and the run length from the meter to the furthest appliance
- The total load of the supplied appliances is 3 x (50 + 25 + 28) = 309CFH
- The run length to the 4th floor Fireplace (furthest appliance) is 5 + 10 + 10 + 10 + 25 = 60ft
- Referring to Table 7-23 (Rigid pipe 0.5"WC pressure drop): for a 60ft run, 1-1/4" pipe has a capacity over 309CF (actual: 530)

### SIZING RUN “C”

- Run “C” is sized by the load of the supplied appliances and the run length from the meter to the furthest appliance
- The total load of the supplied appliances is  $2 \times (50 + 25 + 28) = 206\text{CFH}$
- The run length to the 4th floor Fireplace (furthest appliance) is  $5 + 10 + 10 + 10 + 25 = 60\text{ft}$
- Referring to Table 7-23 (Rigid pipe 0.5"WC pressure drop): for a 60ft run, 1" pipe has a capacity over 206CFH (actual: 260)

### SIZING RUN “D”

- Run “D” is sized by the load of the supplied appliances and the run length from the meter to the furthest appliance
- The total load of the supplied appliances is  $50 + 25 + 28 = 103\text{CFH}$
- The run length to the 4th floor Fireplace (furthest appliance) is  $5 + 10 + 10 + 10 + 25 = 60\text{ft}$
- Referring to Table 7-23 (Rigid pipe 0.5"WC pressure drop): for a 60ft run, 3/4" pipe has a capacity over 103CFH (actual: 138)

Sizing Runs E1, F1, G1, E2, F2 and G2 are similar to the sizing of E3, F3 and G3.

### SIZING RUN “E3”

- Run “E3” is sized by the load of the supplied appliances and the run length from the meter to the supplied appliance
- The load of the dryer is 28CFH
- The run length to the dryer is  $5 + 10 + 10 + 15 = 40\text{ft}$
- Referring to Table 7-4 (2"WC pressure drop) for a 40ft run, 3/8" CSST has a capacity of 28CFH (actual: 32)

### SIZING RUN “F3”

- Run “F3” is sized by the load of the supplied appliances and the run length from the meter to the supplied appliance
- The load of the fireplace is 25CFH
- The run length to the fireplace is  $5 + 10 + 10 + 25 = 50\text{ft}$
- Referring to Table 7-4 (2"WC pressure drop) for a 50ft run, 3/8" CSST has a capacity 25CFH (Check against fireplace sizing)
- Referring to Table 4-6 (Fireplace Sizing), 1/2" CSST has a capacity over 25CFH (actual: 83)
- Using the larger result, this run will be sized to 1/2" CSST

### SIZING RUN “G3”

- Run “G3” is sized by the load of the supplied appliances and the run length from the meter to the supplied appliance
- The load of the water heater is 50CFH
- The run length to the water heater is  $5 + 10 + 10 + 15 = 40\text{ft}$
- Referring to Table 7-4 (2"WC pressure drop) for a 40ft run, 1/2" CSST has a capacity over 50CFH (actual: 93)

### SIZING RUN “E4”

- Run “E4” is sized by the load of the supplied appliances and the run length from the meter to the supplied appliance
- The load of the dryer is 28CFH
- The run length to the dryer is  $5 + 10 + 10 + 10 + 15 = 50\text{ft}$
- Referring to Table 7-4 (2"WC pressure drop) for a 50ft run, 3/8" CSST has a capacity of 28CFH (actual: 29)

### 3.2.12 Example 11 - Commercial Hybrid System – 7"WC (continued)

#### SIZING RUN "F4"

- Run "F4" is sized by the load of the supplied appliances and the run length from the meter to the supplied appliance
- The load of the fireplace is 25CFH
- The run length to the fireplace is  $5 + 10 + 10 + 10 + 25 = 60\text{ft}$
- Referring to Table 7-4 (2"WC pressure drop) for a 60ft run, 3/8" CSST has a capacity over 25CFH (Check against fireplace sizing)
- Referring to Table 4-6 (Fireplace Sizing), 1/2" CSST has a capacity over 25CFH (actual: 76)
- Using the larger result, this run will be sized to 1/2" CSST

#### SIZING RUN "G4"

- Run "G4" is sized by the load of the supplied appliances and the run length from the meter to the supplied appliance
- The load of the water heater is 50CFH
- The run length to the water heater is  $5 + 10 + 10 + 10 + 15 = 50\text{ft}$
- Referring to Table 7-4 (2"WC pressure drop) for a 50ft run, 1/2" CSST has a capacity over 50CFH (actual: 83)



## SECTION 4.0 INSTALLATION PRACTICES

### 4.1 General Provisions

- a) Precautions must be taken to ensure any exposed Gastite®/FlashShield™ CSST is not damaged or abused during building construction. All tubing, fittings and hardware should be stored in a clean, dry location prior to installation.
- b) Open ends of the tubing are to be temporarily plugged or taped closed prior to installation to prevent entrance of dirt, dust or other debris.
- c) The protective plastic jacketing should be kept in place as much as possible to protect the tubing from corrosive threats. Contact with chemicals containing chlorides must be followed by a thorough rinse and wipe dry. This includes fluxes used to solder copper tubing and acid based cleaners used to wash masonry.
- d) Protect tubing from contact with sharp objects.
- e) Avoid stressing the tubing or fittings with tight bends, kinks, twists, stretching or repetitive bending. Refer to Table 4-1 below for the recommended minimum bend radius for Gastite®/FlashShield™ CSST (Fig. 4-1).

Gastite®/ FlashShield™ Size	EHD	Absolute Min. Bend Radius	Suggested Bend Radius
3/8"	13	3/4"	3.0"
1/2"	18	3/4"	3.0"
3/4"	23	1.0"	3.0"
1"	31	3.0"	5.0"
1-1/4"	37	3.0"	5.0"
1-1/2"	48	3.0"	5.0"
2"	60	4.0"	6.0"

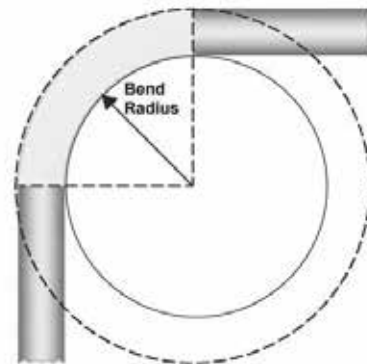

Fig. 4-1

- f) Supporting Gastite®/FlashShield™ CSST - Tubing shall be supported in a workmanlike manner with pipe straps, bands or hangers suitable for the size and weight of the tubing, at intervals not to exceed those shown in Table 4-3. A proper support is one which is designed as a pipe hanger, does not damage the tubing during installation, and provides full support. "J" Hooks may not be used as they may damage the Gastite®/FlashShield™ CSST. Zip ties/cable ties are not to be used as a primary support but may be used to organize or bundle Gastite®/FlashShield™ CSST. See Table 4-5 for supporting Gastite®/FlashShield™ CSST in a rooftop application.



When supporting Gastite® CSST tubing runs, the use of other conductive metallic systems such as metallic appliance vents, metallic ducting and piping, and electrical cables must be avoided.



When supporting FlashShield™ tubing runs, contact with other conductive metallic systems is acceptable.

- g) Gastite®/FlashShield™ CSST must be rigidly terminated with a Gastite® or FlashShield™ fitting. This can be achieved by terminating with a rigidly mounted fitting or by terminating with a fitting threaded onto a rigid gas-piping component.

## 4.2 Field Fitting Assembly Procedure

### 4.2.1 Gastite Field Fitting Assembly

#### Step 1

##### Cut-to-Length (Fig. 4-2)

Cut tubing to the desired length leaving approximately one inch for fitting attachment. Cut should be centered between two corrugations. Use light roller pressure with extra rotations in one direction to leave tubing round and free of burrs. Note: To ensure a quality flare, all cuts should be made on a straight section of tubing.



Fig. 4-2

#### Step 2

##### Strip Jacket (Fig. 4-3)

Using a utility knife, strip jacket back to the valley of the second corrugation. Do not cut the jacket in such a way that the sealing surface of the tubing is scored. The short piece of jacket can easily be removed by placing the utility knife blade under the jacket to peel the jacket off.

*Caution: Tube ends are sharp, use care when handling.*



Fig. 4-3

#### Step 3

##### Install Nut and Bushings (Fig. 4-4)

Thread fitting body into appliance. Slide nut over tubing. Separate bushings and position as shown in Figure 4-6, into the valley of the first corrugation leaving one corrugation exposed between the end of the bushing and tubing.

At this point, the bushings will begin to capture the jacket for a contaminant resistant seal (Fig. 4-5).



Fig. 4-4

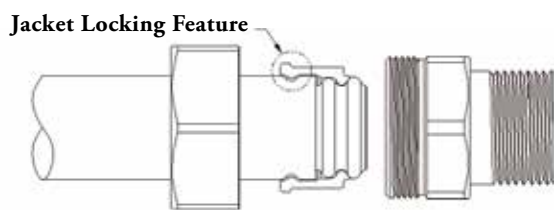

Fig. 4-6

#### NOTE:

- It is important to know that the jacket locking feature of the Jacket-Lock fitting is not required to produce a gas-tight seal between the fitting and the tubing (Fig. 4-6).
- Pipe dope or sealant must not be used inside the fitting prior to assembly.



Fig. 4-5

**Step 4****Position Bushings (Fig. 4-7)**

Insert bushings into fitting body. A small amount of resistance indicates the bushings are being compressed to further capture the jacket. Note: The piloting feature of the bushings ensures the tubing is aligned properly with the fitting body for a uniform flare and a gas tight seal.

**Fig. 4-7****Step 5****Wrench Fitting (Fig. 4-8)**

Slide nut over bushings and thread onto fitting body. Some resistance will be experienced as the nut begins to compress the tubing and create the double wall flare.

Continue to thread the nut until resistance to wrenching increases greatly and the double wall flare is tightly seated.

Note: During the tightening process rotate the nut only. Do not rotate the fitting body.

Any portions of the exposed stainless steel tubing shall be wrapped with tape or sleeved to prevent threats by acids or chloride based cleaning solutions for masonry. Self-bonding silicone tape is recommended here for durability.

**Fig. 4-8**

## 4.2.2 FlashShield Field Fitting Assembly

## Step 1

**Cut-to-Length (Fig. 4-9)**

Cut tubing to the desired length leaving approximately one inch for fitting attachment. Cut should be centered between two corrugations. Use light roller pressure with extra rotations in one direction to leave tubing round and free of burrs. Note: To ensure a quality flare, all cuts should be made on a straight section of tubing.



Fig. 4-9

## Step 2

**Strip Jacket (Fig. 4-10, Fig. 4-11)**

Using a utility knife, strip jacket back to the valley of the second corrugation. Do not cut the jacket in such a way that the sealing surface of the tubing is scored. The short piece of jacket can easily be removed by placing the utility knife blade under the jacket to peel the jacket off.

*Caution: Tube ends are sharp, use care when handling.*



Fig. 4-10

## Step 3

**Install Nut and Bushings (Fig. 4-12)**

Thread fitting body into appliance. Slide nut over tubing. Separate bushings and position, as shown in Figure 4-13, into the valley of the first corrugation leaving one corrugation exposed between the end of the bushing and tubing.

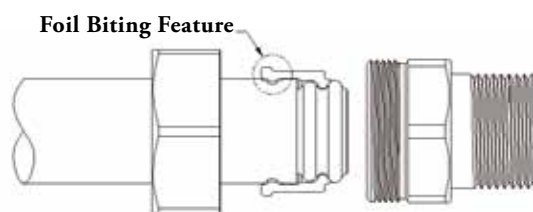

Fig. 4-13



Fig. 4-11



Fig. 4-12

**NOTE:**

- Foil biting feature must be utilized with FlashShield.
- Pipe dope or sealant must not be used inside the fitting prior to assembly.
- The use of FlashShield fittings in combination with Gastite yellow tubing is an acceptable practice.

**Step 4**

**Position Bushings (Fig. 4-14)**

Insert bushings into fitting body. A small amount of resistance indicates the bushings are being compressed to further capture the jacket. Note: The piloting feature of the bushings ensures the tubing is aligned properly with the fitting body for a uniform flare and a gas tight seal.



**Fig. 4-14**

**Step 5**

**Wrench Fitting (Fig. 4-15)**

Slide nut over bushings and thread onto fitting body. Some resistance will be experienced as the nut begins to compress the tubing and create the double wall flare.

Continue to thread the nut until resistance to wrenching increases greatly and the double wall flare is tightly seated.

Note: During the tightening process rotate the nut only. Do not rotate the fitting body.

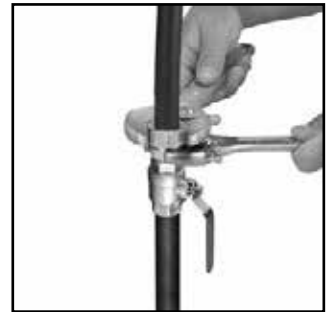

**Fig. 4-15**

**Gastite®/FlashShield™ Termination Fitting Assembly**

- 1) Remove flange from brass fitting assembly.
- 2) Slide flange over tubing.
- 3) Attach brass fitting to tubing (Steps 2 - 5).
- 4) Thread flange back onto fitting assembly.
- 5) Mount completed termination assembly.

Table 4-2		
Gastite®/FlashShield™ Recommended Torque Values		
Size	EHD	*Torque
3/8"	13	25 ft-lbs
1/2"	18	35 ft-lbs
3/4"	23	45 ft-lbs
1"	31	65 ft-lbs
1-1/4"	37	95 ft-lbs
1-1/2"	48	120 ft-lbs
2"	60	150 ft-lbs
* Fitting is factory lubricated to reduce field torque requirements. Lubrication must be chloride free.		
* Minimum torque values supplied for lab testing reference only. Field installation requirements: system must pass pressure/leak test (See Section 6).		

**Term Bracket Fitting (Fig. 4-16 through Fig. 4-19)**

- 1) Attach Bracket to stud or mounting surface.
- 2) Slide Jam-Nut over tubing and route tubing through Bracket.
- 3) Attach XR2-Fitting to tubing.
- 4) Slide the XR2-Fitting back onto Bracket and thread Jam-Nut.



Step 1: Fig. 4-16



Step 2: Fig. 4-17



Step 3: Fig. 4-18



Step 4: Fig. 4-19

**XROUTLETBOX (Fig. 4-20 through Fig. 4-24)**

- 1) Mount Box and Bracket to stud or mounting surface.
- 2) Slide Jam-Nut over tubing and route tubing through Bracket and Box.
- 3) Attach Fitting to tubing.
- 4) Secure Jam-Nut to Fitting.
- 5) Attach Ball-Valve.



Step 1: Fig. 4-20



Step 2: Fig. 4-21



Step 3: Fig. 4-22



Step 4: Fig. 4-23



Step 5: Fig. 4-24

*Note: Strike Protection (Floppy) not shown for clarity.*

**ANGLE STUB-OUT (Fig. 4-25 through Fig. 4-27)**

- 1) Attach XR2 female fitting to short end of Stub-Out.
- 2) Insert long end of Angle Stub-Out through metal insert knockout.
- 3) Secure Stub-Out utilizing sheet metal screws at the four mounting points.
- 4) Insert CSST into the female fitting and complete fitting assembly.
- 5) Refer to Section 4.6.4 (g).



Fig. 4-27

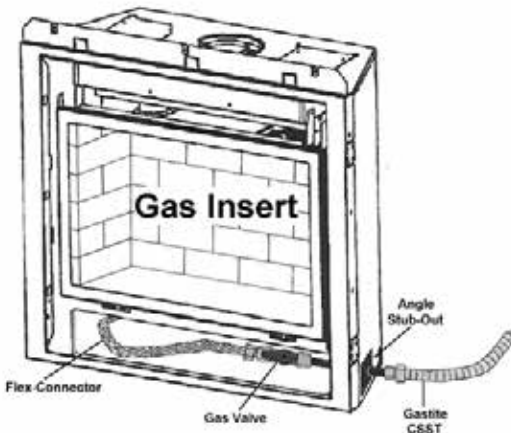

Fig. 4-5

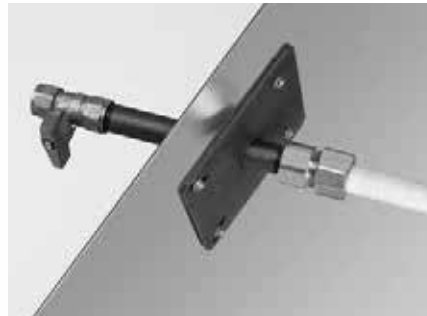

Fig. 4-26

### 4.3 Routing

#### 4.3.1 Vertical Runs

Vertical runs are the preferred run method. Tubing runs should be relatively plumb and free to move within the wall cavity without any physical support between the floors. For support requirements refer to Section 4.1.f. Where any run is greater than two stories or 20-ft, additional support (appropriate to the weight of the tubing) must be provided at the point of penetration through the floor.



Care should be taken when installing vertical runs to maintain as much separation as reasonably possible from other electrically conductive systems in the building.



There is no requirement to maintain separation from other electrically conductive systems when routing FlashShield™

#### 4.3.2 Horizontal Runs

Tubing routed on top of ceiling joists and other structural members which comply with the horizontal support spacing requirements will be considered sufficiently supported. See Figures 4-28, 4-29, 4-30 and 4-31 for examples of acceptable support configurations when routing Gastite®/FlashShield™. Gastite®/FlashShield™ may be routed beneath, through and alongside floor and ceiling joists. Due consideration must be given to future construction possibilities. Horizontal runs in concealed areas must conform to Section 4.4 Protection.



Care should be taken when installing horizontal runs to maintain as much separation as reasonably possible from other electrically conductive systems in the building.



There is no requirement to maintain separation from other electrically conductive systems when routing FlashShield™.



Fig. 4-28



Fig. 4-29



Fig. 4-30



Fig. 4-31

Table 4-3		
Support Spacing (Non-Rooftop, Non-Wall Cavity)		
Gastite®/ FlashShield™ Size	EHD	Vertical or Horizontal
3/8"	13	4 Feet
1/2"	18	6 Feet
3/4"	23	8 Feet (USA) 6 Feet (Canada)
1"	31	8 Feet (USA) 6 Feet (Canada)
1-1/4"	37	8 Feet (USA) 6 Feet (Canada)
1-1/2"	48	8 Feet (USA) 6 Feet (Canada)
2"	60	8 Feet (USA) 6 Feet (Canada)

Table 4-4	
Gastite®/FlashShield™ Clearance Holes	
Gastite®/ FlashShield™ Size	Drill Hole Size (min)
3/8"	1"
1/2"	1-1/4"
3/4"	1-1/2"
1"	1-3/4"
1-1/4"	2"
1-1/2"	2-1/4"
2"	3"

#### 4.3.3 Installation Clearance Holes

Clearance holes for routing Gastite®/FlashShield™ CSST are to be approximately 1/2 inch greater than the O.D. of the Gastite®/FlashShield™ CSST. Drilling of any structural member must be in conformance with the local building code. Refer to Table 4-4 for the recommended drill hole sizing.



#### 4.3.4 Concealed Fittings

The Gastite®/FlashShield™ Mechanical Fittings have been tested and listed per the requirements of ANSI LC-1 for concealed use. The fitting may be used for concealed attachment including, but not limited to: appliance valves, branch runs using tee fittings, length splices and stub-outs manufactured from approved fuel gas piping materials.

These guidelines address some of the most common situations where concealing the fittings is the only practical alternative. These guidelines cannot address all applications of concealed fittings, but instead, provide typical instructions to demonstrate the principles that apply to fittings listed for installation in concealed locations. (Reference National Fuel Gas Code, NFPA 54, Concealed Piping in Buildings).

- a) New Installations (Fig. 4-32) – When multiple gas outlets are supplied from a single run of Gastite® FlashShield™ CSST, each downstream outlet branch can be connected to the main run using a tee-type fitting which can be located in a concealed location.
- b) Fireplace key valves (Fig. 4-33) – Gastite® FlashShield™ CSST connections to fireplace key valves can be located in a concealed location when accessibility is not readily provided.
- c) Stub-outs (Fig. 4-34) – Gastite®/FlashShield™ CSST connections to stub-outs fabricated from approved fuel gas piping materials.

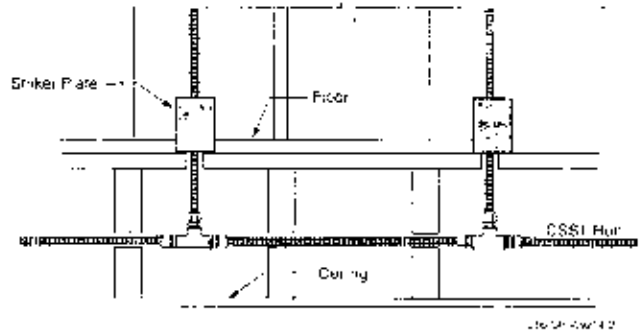

Fig. 4-32

- d) Exclusion – Manifold stations for dual pressure systems which include the multi-port manifold, shut-off valve and pressure regulator shall not be installed in concealed locations regardless of the qualifications of the tubing.



Fig. 4-33

Note: Strike Protection (Floppy) not shown for clarity.



Fig. 4-34

#### 4.3.5 Modifications to Existing Systems

- a) New Ceilings in Unfinished Rooms/Basements – Gastite®/FlashShield™ CSST fittings originally installed in accessible ceiling locations can be concealed in the event a ceiling is installed at a later date.
- b) Extensions to Existing Tubing Runs – Concealed tubing can be modified to permit an extension to another appliance location provided there is sufficient capacity to supply both appliances at the same time. If an accessible location for the modification is not available, the existing tubing run can be modified with a tee fitting that will result in a concealed fitting behind the wallboard.
- c) When modifications lead to concealed tubing, strike protection may be required. Refer to section 4.4.

#### 4.3.6 Outdoor

Gastite®/FlashShield™ Flexible Gas Tubing has passed all requirements of ANSI LC1, which include testing for suitability for exposure of CSST piping systems to outdoor environments.

- a) Outdoors – When installed outdoors, the external jacketing shall remain intact as much as practical for the given installation. Any portions of the exposed stainless steel tubing shall be wrapped with tape or sleeved to prevent later threats by acid or chloride based cleaning solutions for masonry. Self-bonding silicone tape is recommended here for durability.
- b) Along side a structure – When installed along the outside of a structure (between the ground and a height of 6 ft) in an exposed condition, the Gastite®/FlashShield™ CSST shall be protected from mechanical damage inside a conduit or chase. A conduit or chase is not required if the tubing is installed in a location that will not subject the Gastite®/FlashShield™ CSST to mechanical damage.

#### 4.3.7 Fire Rated Construction

The Gastite® plastic jacket on the steel tubing has a maximum ASTM E84 rating of 15 for flame spread, and 30 for smoke density. These values meet most typical requirements for building construction. Therefore, the jacket should remain intact when passing through typical building constructions such as plenums, floor and ceiling joists, rim joists, walls or other fire rated resistance construction limited to materials of ASTM E84 ratings of 25 flame and 50 smoke, or lower.

The FlashShield jacket has a maximum ASTM E84 rating of 5 for flame spread and 30 for smoke density. These values meet most typical requirements for building construction. Therefore, the jacket should remain intact when passing through typical building construction such as plenums, floor and ceiling joists, rim joists, walls, and other fire rated resistance construction limited to materials of ASTM E84 ratings of 25 flame and 50 smoke or lower.

A plenum is defined as an enclosed portion of the building structure that is designed to allow air movement, and thereby serve as part of an air distribution system. (See definition of Plenum, Section 8.0.) No gas tubing may be run within ductwork. For tubing passing through a UL classified fire rated construction, UL Classified Systems for “Through-Penetration Firestop Systems (XHEZ)” may be found in UL Fire Resistance Volume 2. In instances that UL specifications for fire rated construction conflict with the current Gastite Design and Installation Guide, UL takes precedence.

UL Through-Penetration Firestop System information is available on the Gastite® Web site at [www.gastite.com](http://www.gastite.com).

#### 4.3.8 Routing Through Masonry Material

“Masonry material” includes but is not limited to brick, concrete, mortar, and stucco. The term “through masonry construction” refers to any enclosed/concealed construction spaces where CSST is routed in close proximity to masonry but does not apply to exposed CSST mounted to a set masonry surface.

When it is necessary to install Gastite®/FlashShield through masonry materials the tubing shall be routed through a conduit that is a ½" larger in diameter (to ease routing) than the OD of the CSST and appropriate for the application. The sleeve must maintain a continuous watertight barrier between the masonry material and the CSST, up to or past the edge of the masonry hole.

Masonry encasement refers to any enclosed/concealed construction within “masonry material” that produces distributed loads. For masonry encasement see Underground Installations (section 4.9).

#### 4.3.9 Installation Within a Chimney Chase



Gastite tubing shall not be installed within a chase and/or enclosure that includes a metallic appliance vent and/or metallic chimney liner that protrudes through and/or past the roof unless:

- Permitted by local building code,
- An express separation distance as required by local code can be achieved along the entire length,
- The vent and/or liner is directly bonded to the grounding electrode system, AND
- There is no physical contact between the metallic vent and/or liner and the Gastite tubing along the entire length of the vent.



FlashShield™ CSST may be routed within a chimney chase, the restrictions of section 4.3.9 (Installation within a chase) do not apply.

**4.3.10 Clearance From the Underside of a Roof Deck**

- a) A minimum of 3 inches of separation should be maintained from the underside of a shingled roof deck to take into account the potential of roof nail penetration due to future repair and/or replacement of the roof.
- b) Gastite CSST shall not come in contact with reflective radiant barrier insulation that is attached to the underside of a roof deck.

**4.4 Strike Protection**

Concealed Gastite®/FlashShield™ CSST should be routed in areas that will minimize the opportunity for physical damage and/or installed in areas where the tubing will be free to move to avoid a potential puncture threat. The tube can be considered free to move when there is at least the tube’s outside diameter of clearance on all sides of the tubing (Fig. 4-36).

Gastite®/FlashShield™ CSST installed in locations subject to physical damage shall be adequately protected. The tubing shall be protected at points of support and when passing through structural members such as studs, joists and plates. Where all three of the following conditions exist mechanical strike protection must be used.

- 1) Concealed – View is obstructed by walls, and structural members.
- 2) Constrained – Tubing is not free to move to avoid puncture threats.
- 3) Within 3 inches of a potential threat – Tubing is routed in locations which are within 3 inches of drills, screws, or nails.

**4.4.1 Strike Plates**

For Gastite®/FlashShield™ CSST which meets all three of the conditions above, the required method for protecting concealed tubing is hardened steel striker plates listed for use with corrugated stainless steel tubing systems. Striker plates are used at all points of penetration through studs, joists, plates or similar structures (Figures 4-35, 4-37, 4-38, 4-39 and 4-40). Striker plates other than those provided or specified by Gastite are strictly prohibited.

The extent of protection shall be defined as follows:

- a) At concealed support points and points of penetration less than 2 inches from any edge of a stud, joist, plate, etc., a listed striker plate is required at the area of support to provide coverage for 5 inches from the point of restraint in one or both directions.



Fig. 4-35

*Note: Steel Stud Construction – Knock teeth off striker plate for steel stud construction. Floppy at corners aids pull-through*



Fig. 4-36



Fig. 4-37



Fig. 4-38



Fig. 4-39



Fig. 4-40

b) At concealed support points and points of penetration 2 to 3 inches from any edge of a stud, joist plate, etc., listed 1/4" striker plates are required to provide protection throughout the area of penetration (Fig. 4-41 and 4-42).

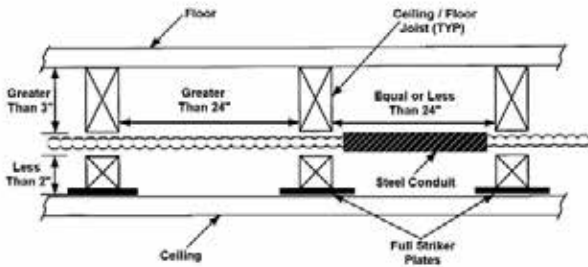

Fig. 4-41

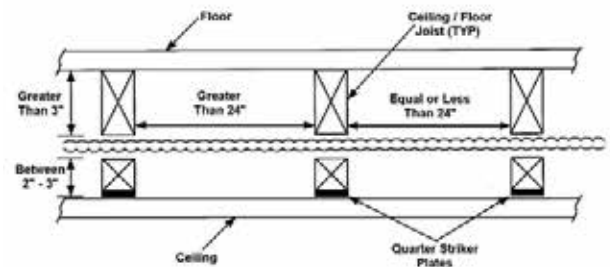

Fig. 4-42

c) When multiple runs are located between the same two studs such as manifold runs or meter bank runs, a 6" x 17" panel type striker plate may be used as an alternate to individual striker plates for each tubing run (Fig. 4-44).



Fig. 4-43



Fig. 4-44

d) When installed inside insulated exterior walls, tubing shall be routed between the face of the insulation and the interior wall surface (Fig. 4-45). If rigid insulation is used, enough space must be provided for movement of the tubing (see Section 4.4) or heavy wall conduit must run over the length of the restrained area.

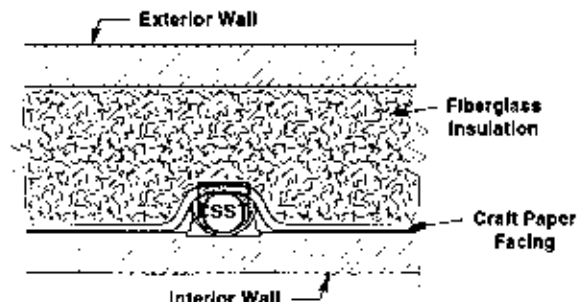

Fig. 4-45

e) At points of penetration greater than 3 inches from any edge of stud, joist, plate, etc., no protection is required.

f) Tubing routed horizontally through structural members shall be protected from puncture threats with the appropriate shielding material (Figure 4-41 and 4-42). At penetration points, listed plates of the appropriate size shall be utilized. Tubing between constraints that are less than 24 inches apart and meeting the criteria requiring full striker plates, shall be additionally protected by Steel Conduit (Fig. 4-43).

g) Gastite®/FlashShield™ CSST greater than 1" nominal diameter installed within a concealed hollow wall cavity of 2"x4" construction shall be protected along the entire concealed run length with Steel Conduit (see Section 4.4.2).

h) The width of installed striker plates shall be at least 1.5 times the outside diameter of the Gastite®/FlashShield™ CSST.

4.4.2 Steel Conduit

At termination points not covered by the ANSI standard, floppy steel conduit (heavy wall) shall be installed as additional protection (Fig. 4-46 and 4-47). Gastite®/FlashShield™ requires a minimum of six inches of conduit and supplies precut conduit in one foot lengths. Floppy Steel conduit should not be used in place of hardened steel striker plates when passing through structural members.



Fig. 4-46

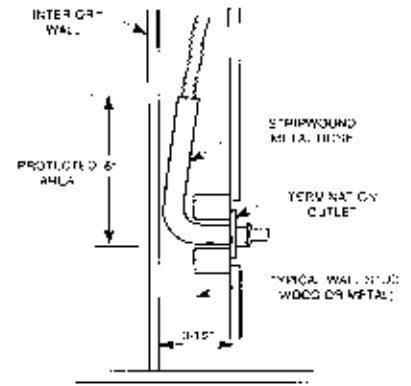

Fig. 4-47

4.5 Meter

The gas piping for the meter stub-out is usually subject to local requirements such as size, location, and material type. It is always important to confirm local code and utility requirements. Gastite®/FlashShield™ recommends the use of 1/2" CSST or greater as the minimum trunk line size. Size 3/8" should not be used for trunk lines. This will allow for the addition of future gas appliances and minimize the opportunity for whistling.

a) Unsupported Meters – Meters that depend on the service supply line and/or the house piping for support shall not be directly connected to the Gastite®/FlashShield™ CSST. As shown in the Figures 4-48 and 4-49, a rigid connection point is created using a Gastite®/FlashShield™ termination fitting, Gastite® designed stub-out or rigid pipe components.



Fig. 4-48



Fig. 4-49

b) Self-Supported Meters – Meters that are independently supported with a bracket can be directly connected to the Gastite®/FlashShield™ CSST as shown in Figure 4-51. If practical, direct Gastite®/FlashShield™ CSST connections shall include a 3 to 6 inch loop of tubing (as shown) to accommodate differential settling and meter movement. No mechanical protection of the tubing is required for outdoor meter connections; however, ensure that the local utility supports this practice as some utilities have regulations specifying meter attachments. Ensure that any exposed sections (jacket removed) of the stainless tubing at the fitting are wrapped with tape. This is especially important with masonry constructions.



Fig. 4-50

c) Electrical bonding connections made at the gas meter must comply with section 4.10 of this guide.



4.6 Appliance

4.6.1 Moveable Appliance

- a) For use with movable appliances, Gastite®/FlashShield™ must be rigidly terminated before the appliance connection. This fixed connection point allows for the attachment of flexible appliance connectors, drip legs (if required), and shut off valves to moveable appliances such as dryers and ranges (Figures 4-51 and 4-52)



Fig. 4-51

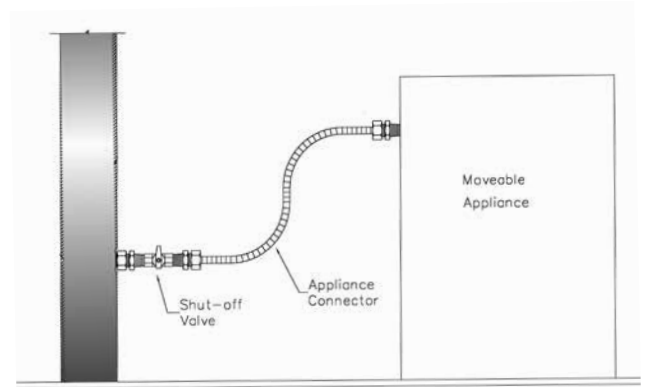

Fig. 4-52

- b) The Appliance Stub-Out is mounted to a stud face (Fig. 4-53) and provides a fixed point to which a Gastite®/FlashShield™ mechanical fitting may be attached. The design of this stub-out ensures that the flexible tubing is routed away from any points of constraint that may subject the tubing to potential puncture threats.

- c) The Straight Stub provides a fixed point for the Gastite®/FlashShield™ mechanical fitting and a stable platform for service meter connections. The Straight Stub may be mounted to the face of a stud (Fig. 4-54) or mounted to an optional Stub Bracket with supplied self-drilling metal screws (Fig. 4-55). The optional bracket is designed to span typical stud construction. The compact design of the straight stub allows for multiple stub-outs within the stud cavity.

The Straight Stub may also be used to pass through joist and wall constructions (Fig. 4-56). It is important to follow all requirements for sleeving when passing through masonry construction.



Fig. 4-53



Fig. 4-54



Fig. 4-55

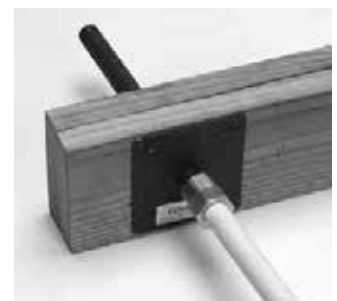



Fig. 4-56

**4.6.2 Direct Connection – Non-Moveable Appliances**

Gastite®/FlashShield™ CSST may be connected directly to non-moveable appliances such as water heaters, furnaces, boilers and island cook-tops (Figures 4-57) without the installation of a termination outlet or flexible appliance connector. All local codes requiring drip legs and shut-off valves must be observed. Drip legs and shut-off valves must be securely mounted. Additionally, Gastite®/FlashShield™ should not penetrate metallic cabinet of appliance.

- a) When appliances such as water heaters, furnaces or fireplaces have metallic vents which extend beyond or protrude through the roof physical contact between the Gastite® CSST and the appliance cabinet or vent is prohibited.  Gastite recommends that all continuous metallic systems be bonded and grounded.

 Physical contact with appliance cabinets that have metallic vents which extend beyond or protrude through the roof is acceptable.

**4.6.3 Gas Convenience Outlet**

- a) Barbecue Grills – Movable grills shall be connected using an approved outdoor appliance connector which shall be attached to the CSST system either at a termination fitting or a quick disconnect device as shown in the figure (Fig. 4-58).
- b) Permanently mounted grills located on decks (Fig. 4-59) shall be connected to the CSST system as shown in the figure and in accordance with the manufacturer’s instructions. The outdoor portion of the CSST run shall be supported against the side of any of the inside deck joists.

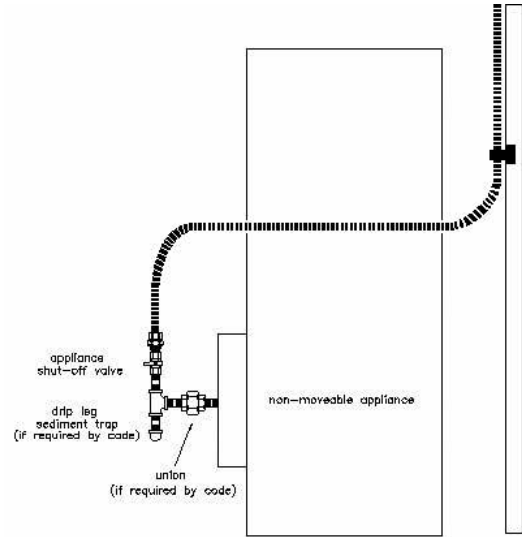

Fig. 4-57

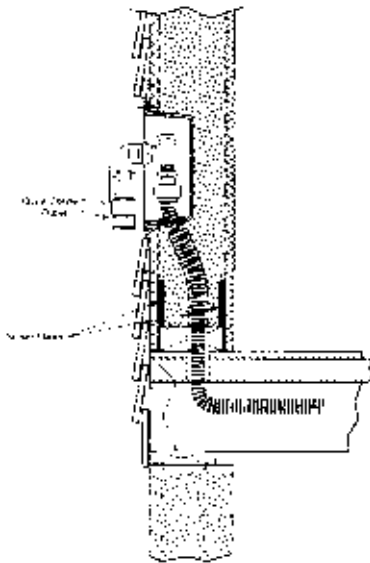
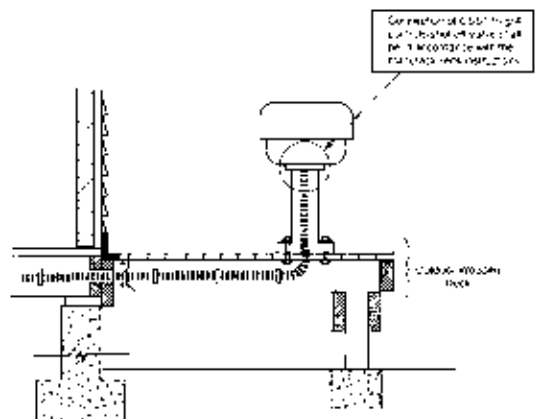

Fig. 4-58



Note: Strike Protection (Floppy) not shown for clarity.

Fig. 4-59



4.6.4 Special Applications

a) Roof Mounted Equipment (Fig. 4-60) – Gastite®/FlashShield™ Flexible Gas Piping can be used in an outdoor rooftop application. When used in this application Gastite® is to be supported off the surface of the roofing material. This support allows for adequate drainage on the roof, product protection from snow, and is commonly required by code.

When Gastite®/FlashShield™ Flexible Gas Piping is installed in an outdoor rooftop application the following requirements must be met:

1. Support materials will be selected to provide an adequate anchoring point that addresses the lightweight flexible nature of Gastite®/FlashShield™. This can be accomplished through either the weight of the support or adhering the support to the roof materials. The support materials must also be selected to be non-damaging to the roofing material. (Check with roof material manufacturer for approved adhering methods and non-damaging materials/installations.)
2. It is also important to select the appropriate metal pipe clamps or straps to firmly affix the tubing to the support.
3. The supports shall lift the tubing at least 3" from the surface of the roof, higher as required by code or local conditions. (Check with local code officials to determine height requirements as defined by the local code or conditions).
4. Support spacing will follow the recommendations as outlined in Table 4-5 below.



Fig. 4-60

Table 4-5		
Roof Top Supporting Space		
Gastite® / FlashShield™ Size	EHD	Max Support Spacing
3/8"	13	6 Feet
1/2"	18	6 Feet
3/4"	23	6 Feet
1"	31	8 Feet
1-1/4"	37	8 Feet
1-1/2"	48	8 Feet
2"	60	8 Feet

Gastite®/FlashShield™ shall penetrate roofing in the manner and using the materials as defined by the roofing manufacturer in order to maintain the manufacturer’s warranty (Figures 4-61 and 4-62). When passing through the deck Gastite®/FlashShield™ must be properly terminated or pass through an appropriate fixed conduit (Figures 4-63 and 4-64). NOTE: As roofing manufacturers generally have proprietary penetration systems and require trained installers, it is extremely important to obtain approval and instructions from the roofing manufacturer prior to performing any work. Failure to do so can result in voiding the roofing warranty.

Lengths of Gastite®/FlashShield™ CSST which run vertically up the side of the building shall be protected in accordance with the General Provisions section of these guidelines, Section 4.3.6.

Note: Roof penetration detailed prints available under “Engineering Specs” at [www.gastite.com](http://www.gastite.com).

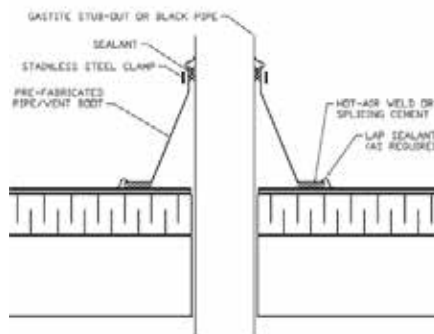

Fig. 4-61

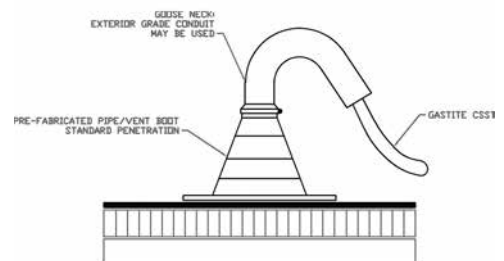

Fig. 4-62

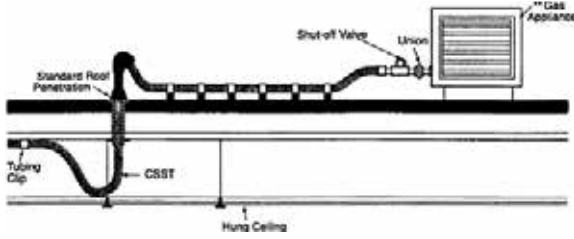

Fig. 4-63

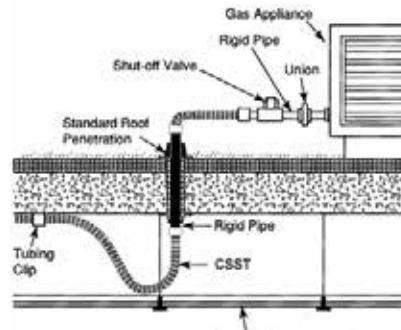

Fig. 4-64

b) Pad Mounted Equipment (Fig. 4-65) – Moveable gas appliances on concrete pads or blocks, such as heat pumps, air conditioners, pool heaters and NGV refueling systems, shall be connected to the Gastite®/FlashShield™ CSST system at a termination fitting using either rigid pipe or an approved outdoor appliance connector.

c) Gas Packs and Other Non-Moveable Equipment (Fig. 4-66) – Can be connected to the Gastite®/FlashShield™ CSST system either through a terminating fitting and rigid pipe or directly with Gastite®/FlashShield™ CSST connected to the appliance shut-off valve.

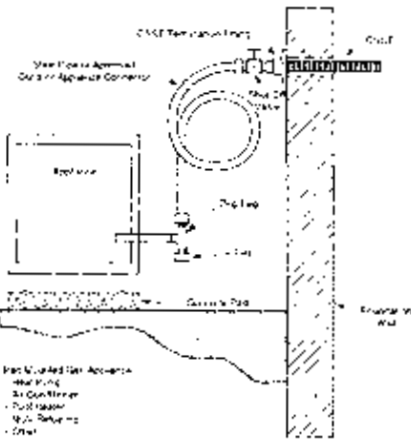

Fig. 4-65

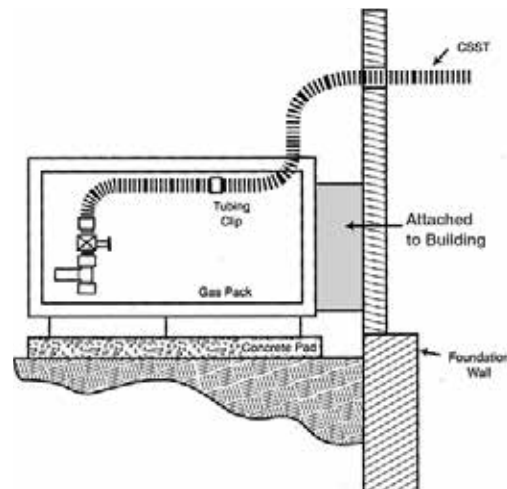

Fig. 4-66

d) Gas Lamps – Permanently mounted lights located on decks shall be connected to the Gastite®/FlashShield™ CSST system in the same fashion as permanently mounted grills as shown in the figure and in accordance with the manufacturers instructions.

e) Yard Mounted Lights – Shall be connected to the Gastite®/FlashShield™ CSST system as shown in Figure 4-67. All Gastite®/FlashShield™ CSST installed below grade shall be installed in accordance with Section 4.9.

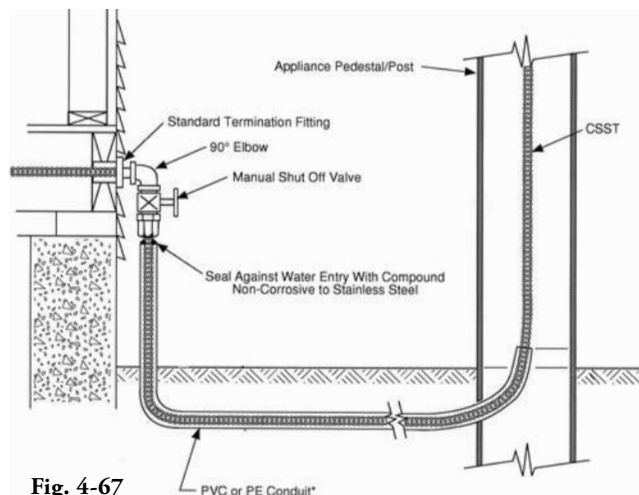

Fig. 4-67

f) Infrared Heaters (Fig. 4-68) - Infrared heaters that are solidly mounted to ceilings and walls of structures may be connected to the Gastite®/FlashShield™ CSST system as shown in the figures below and in accordance with the manufacturers instructions. High Density infrared heaters generally fall into this category. Gastite®/FlashShield™ CSST should be mounted to a fixed point and not on the end involved with the typical expansion and contraction associated with these heaters.

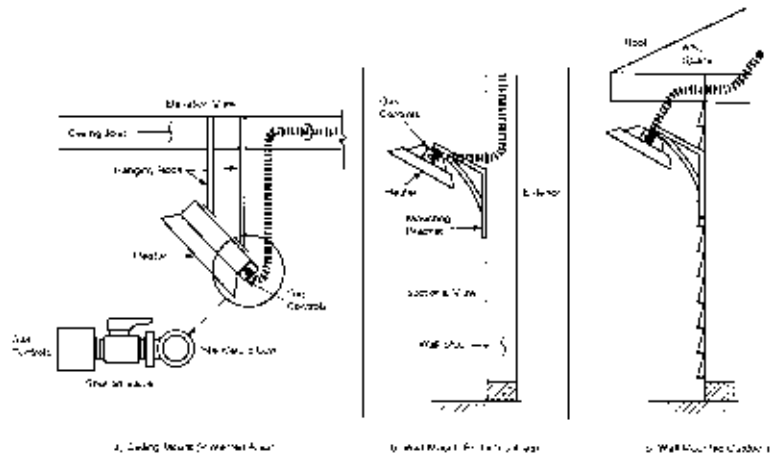

Fig. 4-68

Infrared heaters that are mounted to allow movement of the heater must use an appropriate appliance/flex connector between the heater and the properly terminated Gastite®/FlashShield™. Low Density heaters, tube heaters and heaters hung from chains fall into this category.

Heaters and installations must comply with ANSI Z83.6, “Standard for gas fired infrared heaters.”

g) Gas Fireplace – Gastite®/FlashShield™ Flexible Gas Tubing may be used to deliver gas directly to the control valve of a gas fireplace (Fig. 4-69). Gastite®/FlashShield™ Flexible Gas Piping may also be used to deliver gas directly to the insert of a gas fireplace in decorative and heat generating fireplaces (Fig. 4-70). Per code valves shall be rigidly mounted.

CSST and Gastite®/FlashShield™ brass fittings should not be used inside the firebox for log lighters/gas wands or in any firebox where wood logs will be burned due to the potential for physical harm to the tubing (Fig. 4-71).

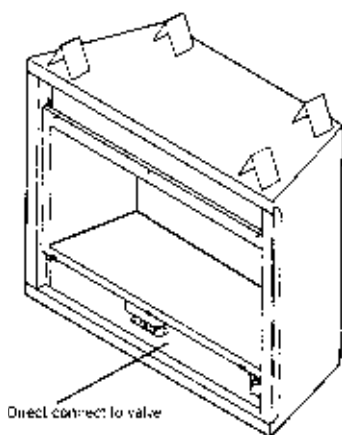

Fig. 4-69

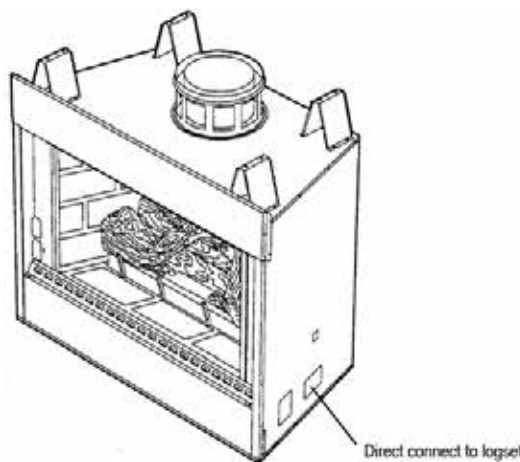

Fig. 4-70

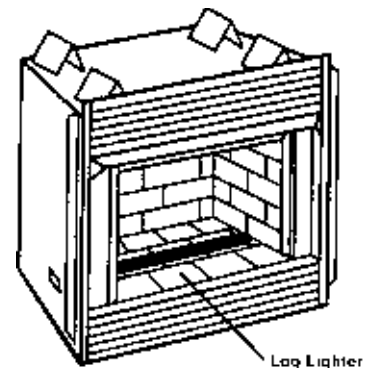
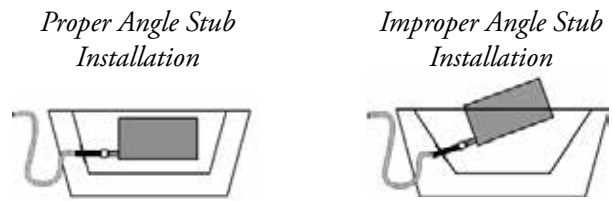

Fig. 4-71

The Gastite® Angle Stub is designed to create a secure mounting point or stub-out for the transition from Gastite®/FlashShield™ CSST to log-lighters, gas logs, or firebox insert’s controls. Refer to Section 4.2 for Angle Stub Installation.

The Gastite® Angle Stub shall not be connected in such a way that the log-lighter, gas log, or other components angle out of the fireplace. To correct for the insertion angle into the firebox, metal shims such as fender washers can be used. (See the proper and improper installation Fig. 4-72)



**Fig. 4-72**

Gastite®/FlashShield™ Mechanical Fittings are approved to be concealed and can be connected directly to a valve controlling gas flow to a fireplace appliance. The Gastite®/FlashShield™ CSST and valve connection can be installed behind the wall, beneath the floor, hearth, or behind the brickwork of the fireplace (Fig. 4-75).

Where it is necessary to install Gastite®/FlashShield™ through masonry materials in fireplace construction, the plastic jacket shall remain intact and the tubing should be routed through sleeving that is appropriate for the application. Sleeving is not required through ceramic liners in decorative fireplaces and heat generating fireplaces.

Gastite®/FlashShield™ may not be run above the flue within a masonry chimney.



Where it is necessary to install Gastite®/FlashShield™ through sheet metal enclosures (such as fireplaces), the tubing should be routed and supported to prevent physical contact with any portion of the metallic enclosure. If direct contact with the enclosure at the point of penetration cannot be avoided, a rubber grommet may be used to prevent physical contact for the penetration. Otherwise, a Gastite® angle stub or rigid pipe components must be used.

In certain configurations corrugated tubing or flexible appliance connectors feeding a fireplace, firepit or gas log set can whistle due to gas flow velocity. Acoustics can usually be avoided by restricting Gastite®/FlashShield™ CSST sizes to the maximum capacity as shown in Table 4-6 below.

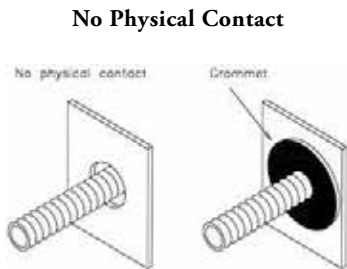

**Fig. 4-73**



**Fig. 4-74**



**Fig. 4-75**

*Note: Strike Protection (Floppy) not shown for clarity.*

Table 4-6		
Fireplace/Fire Pit		
Gastite®/FlashShield™ Size	EHD	BTUH
1/2"	18	45,000
3/4"	23	80,000
1"	31	125,000

## 4.7 Manifold

Manifolds are installed where multiple runs are made from a common location in a parallel arrangement. The manifold may be manufactured from a one-piece malleable iron or brass casting (Fig. 4-76), a welded fabrication of steel sub-components or an assembly of approved, malleable iron tees and short nipples (Fig. 4-77). Manifolds must be rigidly installed. This can be achieved through the use of a mounted manifold bracket or by rigidly piping into a non-movable gas-piping component.

Depending on the location and available space, different mounting arrangements are permitted. A manifold may be mounted in any orientation on the surface of an interior wall, between open floor joists, in attic spaces, crawl spaces, within a partition wall, or inside an enclosure. A manifold assembly without a regulator can be concealed.

The Gastite®/FlashShield™ CSST Capacity Tables include losses for four 90° bends and two end fittings. Tubing runs with a larger number of bends and/or fittings shall be increased by an equivalent length of tubing to the following equation:  $L=1.3n$  where L is additional length of tubing and n is the number of additional fittings and/or bends. Each port of a manifold can be taken as an additional fitting. For example: the tube running from the last port of a 3-port manifold should have 3.9 feet (3 ports/fittings x 1.3) added to the run length for the purpose of sizing. This method is applicable for all manifolds whose ports are equal or greater in size than the pipe connected to the corresponding port.

The installation of manifold assemblies using a pounds-to-inches regulator must be in accordance with all local codes, and the following guidelines:

- A manifold assembly directly integrating a pounds-to-inches regulator shall be installed in an accessible location so that the regulator can be inspected, maintained and serviced if repair or replacement is required.
- For manifold systems that use a pounds-to-inches regulator installed behind an access panel, all tubing penetrations in the cabinet should be sealed, caulked or grommeted. The cabinet must be ventilated through the panel/door and not into a wall space.

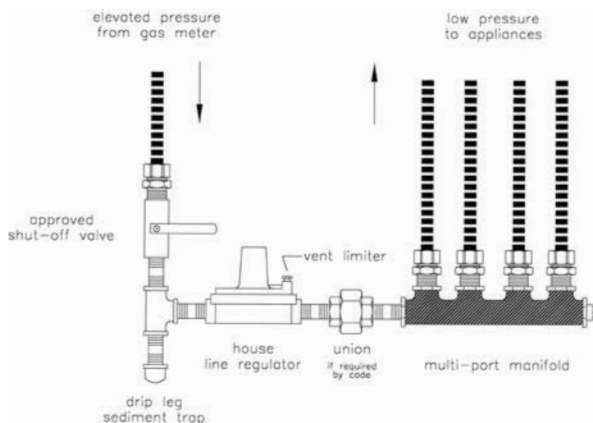

Fig. 4-76

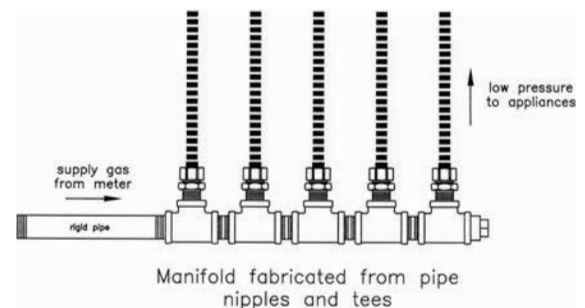

Fig. 4-77

- Open face cabinets (Fig. 4-78), which open on to the normal room environment, may be utilized without the need for ventilation or penetration sealing requirements.



Fig. 4-78



## 4.8 Pressure Regulator

### 4.8.1 Introduction (Fig. 4-79)

A Gastite®/FlashShield™ CSST system using line gas pressures above the maximum appliance input rating shall use a regulator to lower the downstream appliance supply pressure to 1/2 PSI, or less. The regulator shall have a lock-up feature that will limit the downstream pressure to 1/2 PSI. Line gas pressures at or below the maximum appliance input rating does not require the use of a line regulator.

A Line Gas Regulator is defined as a pressure regulator placed in a gas line between the service regulator and the appliance regulator. Regulators supplied by Gastite Division are designed to supply the highest performance as Line Gas Regulators and feature precise regulating control from full flow down to pilot flows.

Regulators must be rigidly installed. This can be achieved by rigidly mounting or piping into a rigid gas-piping component.

Fig. 4-79

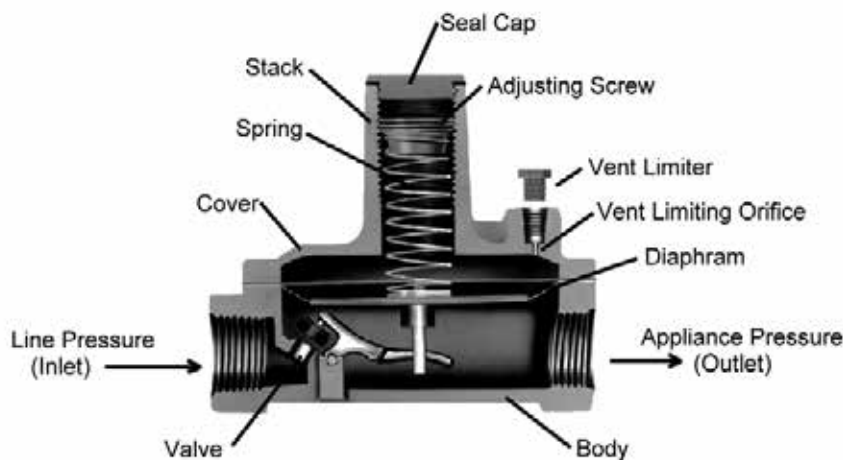

### 4.8.2 Sizing Instructions

Line Pressure Regulator Selection (Tables 4-7 through 4-10).

Line pressure regulators are typically used in a 2 or 5 PSI gas piping installation to reduce supply pressure to the appliance within required operating ranges (typically 4"WC - 8"WC natural gas or 10"WC - 11"WC LP gas).

Regulators Supplied by Gastite Division:

- 1) For natural gas, the regulator outlet pressure is set to 8"WC and the appliance runs are sized with a 3"WC pressure drop. This will allow for 5"WC inlet pressure at the appliance.
- 2) For propane gas, the regulator outlet pressure is set to 11"WC and the appliance runs are sized with a 0.5"WC drop. This will allow for a 10.5"WC inlet pressure at the appliance.

To select the correct regulator for pressure regulation, the following information must be established:

- Available inlet pressure range at the regulator inlet.
- Desired outlet pressure.
- Total maximum flow rate vs. regulator model number (Table 4-7 through Table 4-9).
- Largest single appliance flow rate vs. regulator model number (Table 4-10).

**Regulator Capacity Tables**

Table 4-7						
Regulator Capacity for Natural Gas with an 8" w.c. Outlet Pressure						
Capacities – 0.64 sp gr gas expressed in CFH (m3/h)						
Model Number	Outlet Pressure	Operating Inlet Pressure				
		1/2 psi (34 mbar)	3/4 psi (52 mbar)	1 psi (69 mbar)	1-1/2 psi (103) mbar	2 psi (138 mbar)
T325-3-44P/Reg8-300	8" w.c.	145 (4.1)	200 (5.7)	250 (7.1)	250 (7.1)	250 (7.1)
T325-5-44P/Reg8-600	8" w.c.	335 (9.5)	475 (13.5)	550 (15.6)	550 (15.6)	550 (15.6)
T325-7AL-NG01	8" w.c.	690 (19.5)	970 (27.5)	1250 (35.4)	1250 (35.4)	1250 (35.4)
T325-3L48 (OPD)	8" w.c.	160 (4.5)	200 (5.6)	200 (5.6)	200 (5.6)	200 (5.6)
T325-5AL600 (OPD)	8" w.c.	345 (9.6)	425 (11.9)	425 (11.9)	425 (11.9)	425 (11.9)
T325-7L-210D (OPD)	8" w.c.	650 (18.4)	900 (25.5)	1250 (35.4)	1250 (35.4)	1250 (35.4)
30051-NG	8" w.c.	386 (10.9)	553 (15.7)	635 (18.0)	850 (24.1)	928 (26.3)
30052-NG	8" w.c.	386 (10.9)	691 (19.6)	848 (24.0)	1063 (30.1)	1155 (32.7)
30053-NG	8" w.c.	386 (10.9)	899 (25.5)	1059 (30.0)	1382 (39.1)	1501 (42.5)
30153-NG	8" w.c.	3189 (90.3)	4638 (131.3)	5297 (150.0)	7230 (204.7)	7891 (223.4)

Capacity value for most typical 2 PSI parallel systems when trunk run is sized to deliver 1 PSI to regulator inlet.

Table 4-8						
Regulator Capacity for Natural Gas with an 11" w.c. Outlet Pressure						
Capacities – 0.64 sp gr gas expressed in CFH (m3/h)						
Model Number	Outlet Pressure	Operating Inlet Pressure				
		1/2 psi (34 mbar)	3/4 psi (52 mbar)	1 psi (69 mbar)	1-1/2 psi (103) mbar	2 psi (138 mbar)
T325-3-44P/Reg11-300	11" w.c.	93 (2.6)	172 (4.9)	225 (6.4)	250 (7.1)	250 (7.1)
T325-5-44P/Reg11-600	11" w.c.	211 (6.0)	391 (11.1)	511 (14.5)	550 (15.6)	550 (15.6)
T325-7AL-NG01	11" w.c.	441 (12.5)	816 (23.1)	1250 (35.4)	1250 (35.4)	1250 (35.4)
T325-3L48* (OPD)	11" w.c.	120 (3.4)	200 (5.6)	200 (5.6)	200 (5.6)	200 (5.6)
T325-5AL600* (OPD)	11" w.c.	260 (7.3)	425 (11.9)	425 (11.9)	425 (11.9)	425 (11.9)
T325-7L-210D* (OPD)	11" w.c.	490 (13.9)	821 (23.2)	1250 (35.4)	1250 (35.4)	1250 (35.4)
30051-NG*	11" w.c.	297 (8.4)	496 (14.0)	628 (17.8)	778 (22.0)	928 (26.3)
30052-LP	11" w.c.	297 (8.4)	621 (17.6)	778 (22.0)	967 (27.4)	1155 (32.7)
30053-NG*	11" w.c.	297 (8.4)	807 (22.9)	1093 (31.0)	1297 (36.7)	1501 (42.5)
30153-NG*	11" w.c.	2349 (66.5)	4121 (116.7)	5264 (149.1)	6593 (186.7)	7921 (224.3)

Capacity value for most typical 2 PSI parallel systems when trunk run is sized to deliver 1 PSI to regulator inlet.

\*Regulator requires in-field adjustment to obtain output pressure of 11".

Table 4-9						
Regulator Capacity for Propane with an 11" w.c. Outlet Pressure						
Capacities – 1.52 sp gr gas expressed in kBTU/h						
Model Number	Outlet Pressure	Operating Inlet Pressure				
		1/2 psi (34 mbar)	3/4 psi (52 mbar)	1 psi (69 mbar)	1-1/2 psi (103) mbar	2 psi (138 mbar)
T325-3-44P/Reg11-300	11" w.c.	147	270	355	395	395
T325-5-44P/Reg11-600	11" w.c.	335	620	810	870	870
T325-7AL-NG01	11" w.c.	700	1290	1811	1811	1811
T325-3L48* (OPD)	11" w.c.	190	315	315	315	315
T325-5AL600* (OPD)	11" w.c.	410	670	670	670	670
T325-7L-210D* (OPD)	11" w.c.	775	1300	2012	2012	2012
30051-NG*	11" w.c.	438	798	1028	1385	1584
30052-LP	11" w.c.	547	997	1285	1731	1981
30053-NG*	11" w.c.	712	1296	1671	2251	2575
30153-NG*	11" w.c.	3724	6784	8741	11775	13470

Capacity value for most typical 2 PSI parallel systems when trunk run is sized to deliver 1 PSI to regulator inlet.

\*Regulator requires in-field adjustment to obtain output pressure of 11".

Table 4-10		
Largest Single Appliance Served by Regulator		
Regulator	Natural Gas (CFH)	Propane (kBTU/h)
	0.64 SG gas	1.52 SG gas
T325-3-44P/Reg11-300	147	395
T325-5-44P/Reg11-600	335	870
T325-7AL-NG01	1250	1811
T325-3L48* (OPD)	190	315
T325-5AL600* (OPD)	410	670
T325-7L-210D* (OPD)	1250	2012



### 4.8.3 Installation

- a) The regulator shall be installed in an accessible location with an approved shut-off valve and drip leg on the inlet side and a union (if required by code) on the outlet side so that it may be inspected, maintained and serviced if repair or replacement is required. The regulator must be installed with gas flow as indicated by the arrow on the casting.
- b) Shut-off valves should be opened and closed slowly. A rapidly opened or closed valve can shock the regulator causing abnormal behavior.
- c) The regulator is suitable for multi-poise mounting. When using a vent-limiting orifice however, the regulator must be mounted in a horizontal upright position.

d) The vent-limiting orifice (Fig. 4-80) is a fail-safe device that permits free air movement above the diaphragm during normal operation. In the unlikely event of a diaphragm rupture, the vent limiting orifice will limit gas escapement to 1.0 CFH natural gas at 2 PSI and 0.65 CFH LP at 2 PSI. Both values are below the ANSI standard of 2.5 CFH. Note: The vent-limiting orifice does not allow gas to escape to the environment during operation.

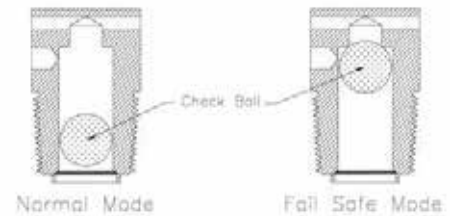

Fig. 4-80

- e) Do not leak test the vent orifice with liquid leak test solution. This action will contaminate the internal check ball mechanism or plug the breathing hole resulting in erratic regulator performance
- f) When using a vent-limiting orifice, the maximum inlet pressure is 2 PSI for Propane and 5 PSI for Natural Gas.
- g) When using a vent line, the line must be at least the same size as the regulator vent connection for all runs up to 30 feet and shall be increased one pipe size over its entirety for every additional 30 feet that the vent runs. Vent lines may be constructed of any approved fuel gas piping, including Gastite®/FlashShield™ CSST. The vent shall be designed to prevent entry of water, insects or other foreign materials that could cause blockage of the line. Do not vent to appliance flue, pilot light or building exhaust system.

h) The regulators supplied by Gastite Division have a temperature range limit of -40 to 240 degrees F. The lower temperature limit and rust proof construction design enables the regulator to be used for outdoor installations. To minimize the potential for moisture condensation and freezing problems in or around the vent port, the vent-limiting orifice must be removed for outdoor installations.



Fig. 4-81

### Outdoor Mounting Options: (Figures 4-81 through 4-83)

The regulator may be mounted upside down with the open vent port facing down. Consideration must be taken to ensure there is adequate clearance for snow buildup.

The regulator may be mounted horizontally, with a vent tube installed in the venting port. The end of the tube must be facing downward, and should be designed to prevent water and foreign material from causing a blockage. Another alternative is an outdoor plastic vent protector designed for the regulator.

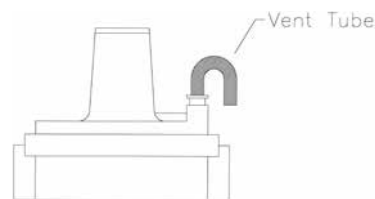

Fig. 4-82



Fig. 4-83

#### 4.8.4 Performance

- a) A performance test should be conducted while operating all appliances at full load. This will test if adequate pressure is reaching each appliance under full-load conditions. To accomplish this, measure the line pressure at the appliance connection while operating the appliance.
- b) The inlet pressure for typical gas appliances under full load conditions should be equal to but not exceeding the appliance's recommended inlet pressure range. If these pressure ranges cannot be obtained, a slight adjustment to the service regulator or the pounds-to-inches regulator may be necessary to increase line pressure.

#### 4.8.5 Regulator Outlet Pressure Adjustment

- a) Adjustment can be accomplished by first removing the regulator seal cap to expose the adjusting screw. Turning the screw clockwise will increase outlet pressure, turning it counter-clockwise will decrease pressure.
- b) If spring adjustment will not produce the desired outlet pressure, check to make sure the main supply pressure is adequate. If the main supply pressure is adequate, consult factory for other line-regulator options. Do not continue to turn regulator adjusting screw clockwise if the outlet pressure readings do not continue to increase. This may result in over-firing due to loss of pressure control, should there be a subsequent increase in inlet pressure.
- c) The line regulators can be adjusted with an outlet pressure ranging between 7 and 11 inches water column. The regulator must be adjusted according to the manufacturer's recommended procedure. A pressure gauge mounted just downstream of the regulator can monitor the set pressure under various loads.

#### 4.8.6 Over-Pressurization Protection

Downstream over-pressure protection must be provided in any gas piping installation where a line-pressure regulator is utilized for pressures in excess of 2 PSI to supply appliances rated for 1/2 PSI or less inlet pressure. Special line regulators of suitable control and capacity must be installed in place of the standard line regulator. This regulator contains an integral over-pressure protection device (OPD) (Fig. 4-84). This special regulator with OPD must be assembled and listed by the manufacturer in accordance with Z21.80, "Standard for line pressure regulators". Refer to Tables 4-7 through 4-9 for OPD capacities and sizing.



Fig. 4-84

NOTE: When using regulators other than those specified by Gastite Division for use with the Gastite® system, careful consideration must be given to the regulator performance characteristics such as required inlet pressure, flow capacity, the pressure drop through the regulator and available outlet pressure.

4.9 Underground Installations

- a) Gastite®/FlashShield™ CSST shall not be buried directly in the ground or directly embedded in concrete (e.g. slab on grade construction, patio slabs, foundations and walkways). When it is necessary to bury or embed Gastite®/FlashShield™ CSST, the tubing shall be routed inside a non-metallic, watertight conduit that has an inside diameter at least 1/2 inch larger than the O.D. of the tubing (Fig. 4-85). For ends of the conduit installed outdoors, the conduit shall be sealed at any exposed end to prevent water from entering.
- b) Venting of the conduit has typically been required because the use of conventional materials such as rigid pipe has usually resulted in some form of connection or union within the conduit. Unlike rigid pipe however, Gastite®/FlashShield™ CSST is continuous with only one fitting at each end of the run, and no fittings inside the conduit. As a result, the possibility of gas build-up due to fitting leaks has been eliminated. Therefore, Gastite Division does not require the sleeving to be vented to the outside of the structure.

If, however, venting is still required, Figure 4-86 below depicts gas piping installed within plastic sleeving that is vented to the outdoors. Other possible venting routes, such as the attic and roof, may also be considered but must be reviewed with the local administrative authority, and must prevent the entry of water and foreign objects.

For ends of Gastite®/FlashShield™ CSST exiting the plastic sleeving, a termination fitting (XR2TRM-#-NF) threaded into an end “plug”, can be used to provide a stable platform for attachment (Fig. 4-87).

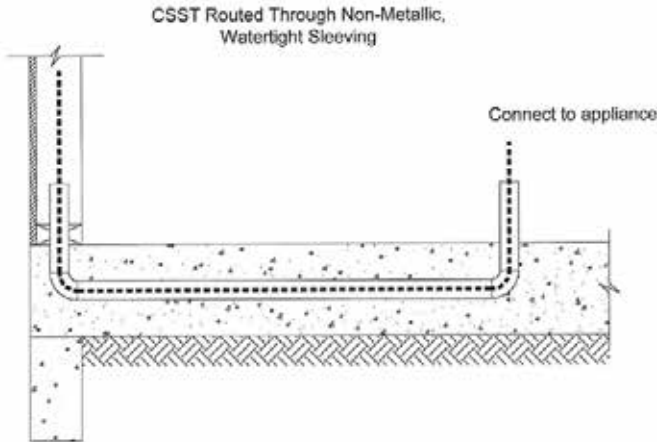

Fig. 4-85

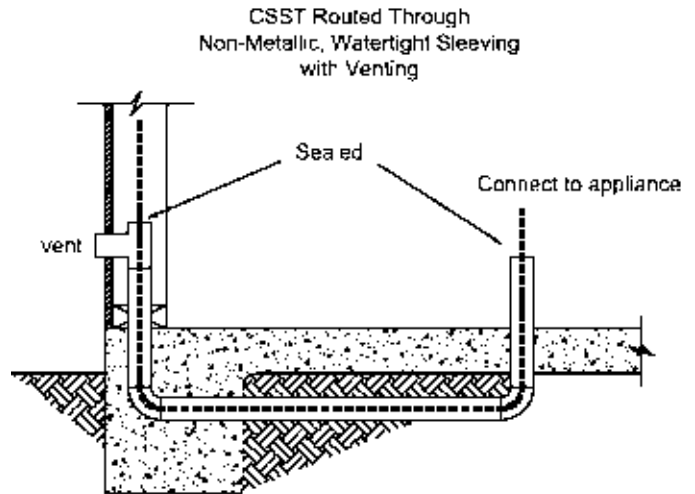

Fig. 4-86



Fig. 4-87

#### 4.10 Electrical Bonding of Gastite®/FlashShield™ CSST

- a) Unlike Gastite®, there are no additional bonding requirements for FlashShield™ imposed by the manufacturer's installation instructions. FlashShield™ is to be bonded in accordance with the National Electrical Code NFPA 70 Article 250.104 in the same manner as the minimum requirements for rigid metal piping. However, installers must always adhere to any local requirements that may conflict with these instructions.
- b) Direct bonding of Gastite® CSST is required for all gas-piping systems incorporating Gastite® CSST whether or not the connected gas equipment is electrically powered. This requirement is provided as part of the manufacturer's instruction for single-family and multi-family buildings. A person knowledgeable in electrical system design, the local electrical code and these requirements should specify the bonding for commercial applications.

Gastite® CSST installed inside or attached to a building or structure shall be electrically continuous and direct bonded to the electrical ground system of the premise in which it is installed. The gas piping system shall be considered to be direct bonded when installed in accordance with the following:

The piping is permanently and directly connected to the electrical service equipment enclosure, the grounded conductor at the electrical service, the grounding electrode conductor (where of sufficient size) or to one or more of the grounding electrodes used. For single and multi-family structures, a single bond connection shall be made downstream of the individual gas meter for each housing unit and upstream of any CSST connection. The bonding conductor shall be no smaller than a 6 AWG copper wire or equivalent. The bonding wire shall be attached in an approved manner in accordance with NEC Article 250.70 and the point of attachment for the bonding wire shall be accessible. Bonding/grounding clamps shall be installed in accordance with its listing per UL 467 and shall make metal-to-metal contact with the piping. This bond is in addition to any other bonding requirements as specified by local codes.

For attachment to the CSST gas piping system, a single bonding clamp must be attached to either a segment of steel pipe, a rigid pipe component or to the Gastite brass hex fitting. For attachment to a segment of steel pipe or a rigid pipe component any bonding clamp listed to UL467 may be used. For attachment to a Gastite hex fitting, clamps manufactured by Erico (part number CWP1JSH for 3/8" & 1/2", CWP2JSH for 3/4" thru 1-1/4" and CWP3JSH for 1-1/2" & 2") must be used. The corrugated stainless steel tubing portion of the gas piping system shall not be used as the point of attachment of the bonding conductor at any location along its length under any circumstances. See examples provided in Figures 4-88 and 4-89.

Proper bonding and grounding will reduce the risk of damage and fire from a lightning strike. Lightning is a highly destructive force. Even a nearby lightning strike that does not strike a structure directly can cause all electrically conductive systems in the structure to become energized. If these systems are not adequately bonded, the difference in electrical potential between the systems may cause the charge to arc from one system to another. Arcing can cause damage to CSST. Direct bonding and grounding as set forth above will reduce the risk of arcing and related damage over a non direct bonded system.

Depending upon conditions specific to the location of the structure in which the Gastite system is being installed, including but not limited to whether the area is prone to lightning, the owner of the structure should consider whether a lightning protection system is necessary or appropriate. Lightning protection systems are beyond the scope of this bulletin, but are covered by NFPA 780, the Standard for the Installation of Lightning Protection Systems and other standards.

**Fig. 4-88 - Bonding Clamp on Steel Pipe Segment or Gastite Stub-Out.**

(Remove any paint or coating on pipe surface beneath clamp location)

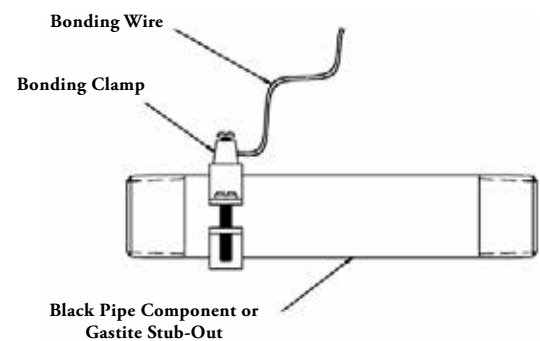

**Fig. 4-89 - Bonding Clamp on Gastite fitting.**  
(Clamp #CWP1JSH, CWP2JSH or CWP3JSH)

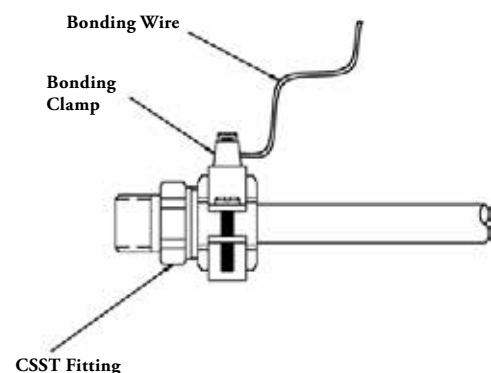

# SECTION 5.0 INSPECTION, REPAIR AND REPLACEMENT

## 5.1 Minimum Inspection Requirements

### Gastite®/FlashShield™ CSST Installation Checklist

Date:	Elevated Pressure:    Yes    No
Contractor::	Comments:
Address:	

- Qualified installer with Certification Card.
- Components from same manufacturer.
- Strike protection.
- System Sizing.
- Connected to fixed appliance only. Flexible connector for moveable appliances.
- Regulator isolated or removed for pressure test.
- Regulator horizontal when using vent limiter.
- Regulator is installed in an accessible location with shut-off valve and drip leg mounted ahead of regulator.
- Jacket kept in place for outdoor installations.
- Sleeved for underground and through masonry.
- Supported but not restricted.
- Bonded per section 4.10.
- Installation within a chase restrictions per section 4.3.9.
- Physical separation per sections 4.3.1 and 4.3.2

## 5.2 Installation Checklist Description

Corrugated Stainless Steel Tubing (CSST) has been design certified by the Canadian Standards Association since 1990 for use as a fuel gas piping system. Gastite®/FlashShield™ CSST has been tested per ANSI LC1 as required for approval and as an approved gas piping material in the National Fuel Gas Code-NFPA 54 & 58, the International Fuel Gas Code-ICC, and with the Uniform Plumbing Code-IAPMO.

### Approval: Conditions and Requirements

A flexible gas piping system using Gastite®/FlashShield™ CSST must be installed in accordance with all local building codes and the manufacturer's instructions. The following checklist is designed to assist the local administrative authority to perform an inspection of a fuel gas piping system using corrugated stainless steel tubing.

- 1) Gastite®/FlashShield™ flexible gas piping may only be installed by a qualified installer who has successfully completed the manufacturer's certification training program. A manufacturer's certification card is required to purchase and install Gastite®/FlashShield™ flexible gas piping.
- 2) Gastite®/FlashShield™ CSST routed in a location which is concealed, constrained and within 3 inches of a potential threat must be protected against damage using protection devices listed in the manufacturer's Design and Installation Guide.
- 3) Gastite®/FlashShield™ CSST should not be connected to moveable appliances. Connections to moveable appliances such as ranges and clothes dryers should be accomplished with a flexible appliance connector.
- 4) Regulators are suitable for multi-poise mounting. When using a vent-limiting device however, the regulator must be mounted in a horizontal upright position.
- 5) A manifold assembly utilizing a pounds-to-inches regulator shall include a ball valve ahead of the regulator and installed in an accessible location so that the regulator can be inspected, maintained and serviced if repair or replacement is required.
- 6) When installed outdoors, the external jacket shall remain intact as much as possible. Exposed portions of the stainless steel tubing shall be wrapped to provide protection from corrosive threats.
- 7) For installations buried underground, under concrete/asphalt or embedded in concrete, Gastite®/FlashShield™ CSST must be routed in a non-metallic watertight conduit which has an inside diameter at least 1/2 in. larger than the outside diameter of the tubing. Under concrete/asphalt slab, sleeved CSST must be buried in accordance with all local codes. No mechanical joints are permitted within the conduit.
- 8) Installation must be properly supported to not only keep the job professional and organized but also to prevent excess strain on the bends and fittings. Supports installed in addition to the practices outlined by Gastite Division, restricts the tubing and increases susceptibility to strike damage.
- 9) Gas piping systems must be properly bonded to the structure's electrical service. A qualified professional following the NEC approved methods as outlined in section 4.10 shall perform the bonding installation.
- 10) Gastite® CSST must be physically separated from other continuous metallic systems in accordance with section 4.3 of this guide.



### 5.3 Repair of Damaged CSST

#### 5.3.1 Determine Damage

Crushed, dented or kinked tubing may result in restricted flow conditions. Use the following guidelines to determine the severity of damage and whether repair or replacement is necessary.

- Gastite®/FlashShield™ CSST gas tubing must be repaired if damaged by puncture of any kind, e.g. nails, screws, drill bits, etc.
- No repairs or replacement of the tubing is necessary if the Gastite®/FlashShield™ CSST tubing is only slightly dented due to impact or crushing and the overall crush depth is less than 1/3 the diameter of the tubing. Minimal flow reduction will occur at this limited damage level.
- Repair or replacement is necessary if the overall crush depth is greater than 1/3 the diameter of the tubing. Restricted flow may occur at this damage level.
- Gastite®/FlashShield™ CSST tubing bent beyond its minimum bend radius so that a crease or kink remains must be repaired. Restricted flow may occur at this damage level.

#### 5.3.2 Method of Repair

A line splice can be made, but if the tubing run is short and easily accessible, the preferred repair method is to replace the entire length. Often, a tubing run can be replaced faster than repairing the damaged section. The Gastite®/FlashShield™ mechanical joint fittings can be removed and easily re-attached. This is the preferred method because it does not add any additional fitting joints to the system.

Where repairs or replacements involve only the Gastite®/FlashShield™ CSST, the tubing can be joined with standard pipe couplings or Gastite®/FlashShield™ CSST coupling (Fig. 5-1).

Where repairs or replacements involve CSST systems of different manufacturers, the systems can be joined through standard pipe couplings and each manufacturer's recommended CSST fitting (Fig. 5-2).

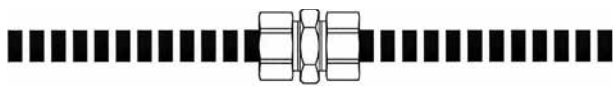

Typical Tubing Splice with Gastite Coupling

Fig. 5-1

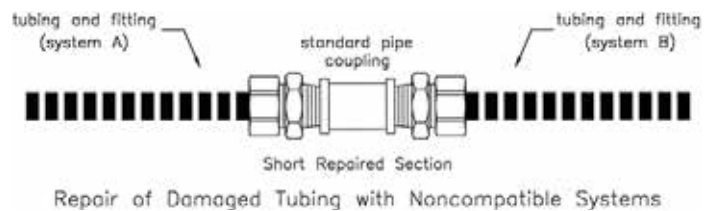

Fig. 5-2



## SECTION 6.0 PRESSURE/LEAKAGE TESTING

### 6.1 General Guidelines for Pressure Testing

- a) The final installation must be inspected and tested for leaks in accordance with the local/state codes. In the absence of local codes, installation must be in accordance with the current edition of the National Fuel Gas Code, ANSI Z223.1/NFPA-54 (USA), or Installation Codes CSA-B149.1 (Canada). Pressure testing must comply with these guidelines or local codes. When local codes are more stringent, local codes must be followed.
- b) Pressure testing must be performed during rough construction of the facility (before interior walls are finished). This will permit a more complete inspection of the piping system during the pressure testing.
- c) Do not connect appliances or pressurize with fuel gas until after the pressure test has been passed.
- d) All gas outlets for appliance connections should be capped during pressure testing.

### 6.2 Elevated Pressure Systems

If an elevated pressure system requires a pressure test of 10 PSI or greater, the regulator must be removed or isolated prior to pressure testing.

The test may be performed as a one-part test replacing the regulator with a suitable jumper pipe length for pressure testing the entire system (Figures 6-1 and 6-2).



Fig. 6-1

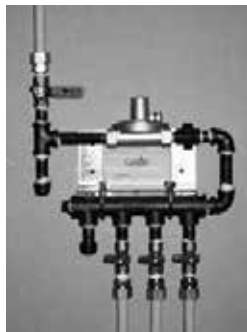

Fig. 6-2



Fig. 6-3

Or a two-part test may be performed as shown in Figure 6-3:

- The first test is performed on the elevated pressure section, between the meter connection and the pounds-to-inches line regulator.
- The second test is performed on the low-pressure section, between the outlet of the pounds-to-inches line regulator and the gas appliance outlets.
- For a two-part test, it is important to remember to close both gas shut-off valves to avoid damage to the regulator.
- When opening the shut-off valves it is important to open them slowly. A quickly opened valve can shock the regulator and cause abnormal regulator behavior.

### 6.3 Appliance Connection Leakage Check Procedure

After the final pressure test, inspection and final construction is complete (finished interior walls), connect the appliances to the system. This connection can be made using an approved flexible connector for movable appliances, or with Gastite®/FlashShield™ CSST tubing or rigid black pipe for fixed appliances. Turn the gas on at the meter and inspect for leakage before operating the appliances.

- a) Connections made at the appliances should be leak checked with a chloride-free bubble solution. Leak check solutions must comply with ASTM E515, or be labeled as non-corrosive.
- b) Before placing the appliances in operation, the tubing system should be purged. This displaces the air in the system with fuel gas. Be sure to vent into a well-ventilated area.

**NOTE: Leak test solutions may cause corrosion in some types of material in the gas tubing system, be sure to water rinse after the test and thoroughly dry all contacted material. Also, the vent limiter should not be leak tested with a liquid test solution. This will contaminate the internal ball check mechanism or plug the breathing hole, resulting in erratic regulator operation.**

**NOTE: Near maximum allowable pressure test levels listed on the Gastite®/FlashShield™ specification sheets, the tubing may move/distort which can affect tubing supports. Once the pressure is released the tubing should return to relatively the same position. Use caution when pressure testing and do not exceed the maximum test pressure.**

# SECTION 7: SIZING TABLES AND PRESSURE DROP CHARTS

For Gastite® and FlashShield™ CSST

## 7.1 CSST Capacity Tables - Natural Gas

Table 7-1																
Maximum Capacity of Gastite®/FlashShield™ Flexible Gas Piping in Cubic Feet Per Hour of <b>Natural Gas</b> with a <b>Gas Pressure of 0.5 psi or Less and a Pressure Drop of 0.5"WC</b> (based on a 0.60 specific gravity gas)																
Tubing		Tubing Length (ft)														
EHD	Size	5	10	15	20	25	30	40	50	60	70	80	90	100	125	150
13	3/8"	47	32	26	22	20	18	15	14	13	12	11	10	10	8	8
18	1/2"	131	93	76	66	59	54	47	42	38	36	33	32	30	27	24
23	3/4"	251	183	152	133	120	110	97	87	80	75	70	67	63	57	53
31	1"	578	415	341	297	267	244	213	191	175	163	153	144	137	123	113
37	1-1/4"	871	620	508	441	396	362	314	282	258	239	224	211	201	180	164
48	1-1/2"	1834	1304	1068	926	830	759	658	590	539	500	468	442	419	376	343
60	2"	3874	2711	2199	1896	1690	1539	1327	1183	1077	994	928	874	827	737	671

Table 7-2																
Maximum Capacity of Gastite®/FlashShield™ Flexible Gas Piping in Cubic Feet Per Hour of <b>Natural Gas</b> with a <b>Gas Pressure of 0.5 psi or Less and a Pressure Drop of 1.0"WC</b> (based on a 0.60 specific gravity gas)																
Tubing		Tubing Length (ft)														
EHD	Size	200	250	300	400	500	600	700	800	900	1000	1100	1200	1300	1400	1500
13	3/8"	7	6	5	5	4	4	3	3	3	3	3	3	2	2	2
18	1/2"	21	19	17	15	14	12	11	11	10	10	9	9	8	8	8
23	3/4"	46	42	38	34	30	28	26	24	23	22	21	20	20	19	18
31	1"	98	88	81	70	63	58	54	50	48	45	43	42	40	39	37
37	1-1/4"	143	128	117	102	91	83	77	72	68	65	62	59	57	55	53
48	1-1/2"	298	267	244	212	190	173	161	150	142	135	129	123	118	114	110
60	2"	579	516	470	405	361	329	304	283	267	253	240	230	221	212	205

Table 7-2																
Maximum Capacity of Gastite®/FlashShield™ Flexible Gas Piping in Cubic Feet Per Hour of <b>Natural Gas</b> with a <b>Gas Pressure of 0.5 psi or Less and a Pressure Drop of 1.0"WC</b> (based on a 0.60 specific gravity gas)																
Tubing		Tubing Length (ft)														
EHD	Size	5	10	15	20	25	30	40	50	60	70	80	90	100	125	150
13	3/8"	67	47	38	32	29	26	22	20	18	17	15	15	14	12	11
18	1/2"	185	131	107	93	83	76	66	59	54	50	47	44	42	38	34
23	3/4"	345	251	209	183	165	152	133	120	110	103	97	92	87	79	72
31	1"	807	578	476	415	372	341	297	267	244	227	213	201	191	172	157
37	1-1/4"	1224	871	714	620	556	508	441	396	362	336	314	297	282	253	231
48	1-1/2"	2581	1834	1502	1304	1168	1068	926	830	759	703	658	621	590	528	483
60	2"	5538	3874	3144	2711	2416	2199	1896	1690	1539	1421	1327	1249	1183	1054	960

Table 7-2																
Maximum Capacity of Gastite®/FlashShield™ Flexible Gas Piping in Cubic Feet Per Hour of <b>Natural Gas</b> with a <b>Gas Pressure of 0.5 psi or Less and a Pressure Drop of 1.0"WC</b> (based on a 0.60 specific gravity gas)																
Tubing		Tubing Length (ft)														
EHD	Size	200	250	300	400	500	600	700	800	900	1000	1100	1200	1300	1400	1500
13	3/8"	10	8	8	7	6	5	5	5	4	4	4	4	4	3	3
18	1/2"	30	27	24	21	19	17	16	15	14	14	13	12	12	11	11
23	3/4"	63	57	53	46	42	38	36	34	32	30	29	28	27	26	25
31	1"	137	123	113	98	88	81	75	70	67	63	60	58	56	54	52
37	1-1/4"	201	180	164	143	128	117	109	102	96	91	87	83	80	77	75
48	1-1/2"	419	376	343	298	267	244	226	212	200	190	181	173	167	161	155
60	2"	827	737	671	579	516	470	434	405	381	361	344	329	315	304	293

Tables include losses for four 90° bends and two end fittings. Tubing runs with a larger number of bends and/or fittings shall be increased by an equivalent length of tubing to the following equation:  $L=1.3n$  where L is additional length of tubing and n is the number of additional fittings and/or bends.

<b>Table 7-3</b>																
Maximum Capacity of Gastite®/FlashShield™ Flexible Gas Piping in Cubic Feet Per Hour of <b>Natural Gas</b> with a <b>Gas Pressure of 0.5 psi or Less and a Pressure Drop of 1.5"WC</b> (based on a 0.60 specific gravity gas)																
Tubing		Tubing Length (ft)														
EHD	Size	5	10	15	20	25	30	40	50	60	70	80	90	100	125	150
13	3/8"	83	58	47	40	36	32	28	25	22	21	19	18	17	15	14
18	1/2"	226	160	131	114	102	93	81	72	66	61	57	54	51	46	42
23	3/4"	416	303	251	220	199	183	160	145	133	124	116	110	105	95	87
31	1"	981	703	578	504	452	415	361	324	297	276	259	244	232	209	191
37	1-1/4"	1493	1063	871	757	678	620	539	483	441	409	383	362	344	308	282
48	1-1/2"	3152	2240	1834	1592	1426	1304	1131	1014	926	859	804	759	720	645	590
60	2"	6825	4775	3874	3340	2978	2711	2337	2083	1896	1752	1635	1539	1457	1299	1183

<b>Table 7-4</b>																
Maximum Capacity of Gastite®/FlashShield™ Flexible Gas Piping in Cubic Feet Per Hour of <b>Natural Gas</b> with a <b>Gas Pressure of 0.5 psi or Less and a Pressure Drop of 2.0"WC</b> (based on a 0.60 specific gravity gas)																
Tubing		Tubing Length (ft)														
EHD	Size	200	250	300	400	500	600	700	800	900	1000	1100	1200	1300	1400	1500
13	3/8"	12	11	10	8	7	7	6	6	5	5	5	5	4	4	4
18	1/2"	37	33	30	26	23	21	20	18	17	17	16	15	15	14	14
23	3/4"	76	69	63	56	50	46	43	40	38	37	35	34	32	31	30
31	1"	167	150	137	119	107	98	91	86	81	77	73	70	68	65	63
37	1-1/4"	245	219	201	174	156	143	132	124	117	111	106	102	98	94	91
48	1-1/2"	512	459	419	364	326	298	276	259	244	232	221	212	204	196	190
60	2"	1020	909	827	713	636	579	535	499	470	445	424	405	389	374	361

<b>Table 7-4</b>																
Maximum Capacity of Gastite®/FlashShield™ Flexible Gas Piping in Cubic Feet Per Hour of <b>Natural Gas</b> with a <b>Gas Pressure of 0.5 psi or Less and a Pressure Drop of 2.0"WC</b> (based on a 0.60 specific gravity gas)																
Tubing		Tubing Length (ft)														
EHD	Size	5	10	15	20	25	30	40	50	60	70	80	90	100	125	150
13	3/8"	97	67	54	47	41	38	32	29	26	24	22	21	20	18	16
18	1/2"	260	185	151	131	118	107	93	83	76	71	66	62	59	53	49
23	3/4"	475	345	287	251	227	209	183	165	152	141	133	126	120	108	100
31	1"	1126	807	664	578	520	476	415	372	341	317	297	281	267	240	220
37	1-1/4"	1719	1224	1003	871	781	714	620	556	508	471	441	417	396	355	324
48	1-1/2"	3632	2581	2114	1834	1643	1502	1304	1168	1068	989	926	874	830	744	680
60	2"	7915	5538	4493	3874	3453	3144	2711	2416	2199	2031	1896	1785	1690	1507	1372

<b>Table 7-4</b>																
Maximum Capacity of Gastite®/FlashShield™ Flexible Gas Piping in Cubic Feet Per Hour of <b>Natural Gas</b> with a <b>Gas Pressure of 0.5 psi or Less and a Pressure Drop of 2.0"WC</b> (based on a 0.60 specific gravity gas)																
Tubing		Tubing Length (ft)														
EHD	Size	200	250	300	400	500	600	700	800	900	1000	1100	1200	1300	1400	1500
13	3/8"	14	12	11	10	8	8	7	7	6	6	6	5	5	5	5
18	1/2"	42	38	34	30	27	24	23	21	20	19	18	17	17	16	16
23	3/4"	87	79	72	63	57	53	49	46	44	42	40	38	37	36	35
31	1"	191	172	157	137	123	113	105	98	93	88	84	81	78	75	73
37	1-1/4"	282	253	231	201	180	164	152	143	135	128	122	117	113	109	105
48	1-1/2"	590	528	483	419	376	343	318	298	281	267	255	244	235	226	219
60	2"	1183	1054	960	827	737	671	620	579	545	516	491	470	451	434	419

Tables include losses for four 90° bends and two end fittings. Tubing runs with a larger number of bends and/or fittings shall be increased by an equivalent length of tubing to the following equation:  $L=1.3n$  where L is additional length of tubing and n is the number of additional fittings and/or bends.

<b>Table 7-5</b>																
Maximum Capacity of Gastite®/FlashShield™ Flexible Gas Piping in Cubic Feet Per Hour of <b>Natural Gas</b> with a <b>Gas Pressure of 0.5 psi or Less and a Pressure Drop of 3.0"WC</b> Line Regulator Outlet (8 in.WC ) (based on a 0.60 specific gravity gas)																
Tubing		Tubing Length (ft)														
EHD	Size	5	10	15	20	25	30	40	50	60	70	80	90	100	125	150
13	3/8"	120	83	67	58	51	47	40	36	32	30	28	26	25	22	20
18	1/2"	318	226	185	160	144	131	114	102	93	86	81	76	72	65	59
23	3/4"	572	416	345	303	273	251	220	199	183	170	160	152	145	130	120
31	1"	1368	981	807	703	631	578	504	452	415	385	361	341	324	291	267
37	1-1/4"	2097	1493	1224	1063	953	871	757	678	620	575	539	508	483	433	396
48	1-1/2"	4435	3152	2581	2240	2007	1834	1592	1426	1304	1208	1131	1068	1014	908	830
60	2"	9755	6825	5538	4775	4256	3874	3340	2978	2711	2504	2337	2199	2083	1857	1690

<b>Table 7-5</b>																
Maximum Capacity of Gastite®/FlashShield™ Flexible Gas Piping in Cubic Feet Per Hour of <b>Natural Gas</b> with a <b>Gas Pressure of 0.5 psi or Less and a Pressure Drop of 3.0"WC</b> Line Regulator Outlet (8 in.WC ) (based on a 0.60 specific gravity gas)																
Tubing		Tubing Length (ft)														
EHD	Size	200	250	300	400	500	600	700	800	900	1000	1100	1200	1300	1400	1500
13	3/8"	17	15	14	12	11	10	9	8	8	7	7	7	6	6	6
18	1/2"	51	46	42	37	33	30	28	26	24	23	22	21	20	20	19
23	3/4"	105	95	87	76	69	63	59	56	53	50	48	46	44	43	42
31	1"	232	209	191	167	150	137	127	119	113	107	102	98	95	91	88
37	1-1/4"	344	308	282	245	219	201	186	174	164	156	149	143	137	132	128
48	1-1/2"	720	645	590	512	459	419	389	364	343	326	311	298	286	276	267
60	2"	1457	1299	1183	1020	909	827	764	713	671	636	605	579	555	535	516

<b>Table 7-6</b>																
Maximum Capacity of Gastite®/FlashShield™ Flexible Gas Piping in Cubic Feet Per Hour of <b>Natural Gas</b> with a <b>Gas Pressure of 0.5 psi or Less and a Pressure Drop of 4.0"WC</b> (based on a 0.60 specific gravity gas)																
Tubing		Tubing Length (ft)														
EHD	Size	5	10	15	20	25	30	40	50	60	70	80	90	100	125	150
13	3/8"	140	97	78	67	60	54	47	41	38	35	32	30	29	25	23
18	1/2"	366	260	213	185	165	151	131	118	107	100	93	88	83	75	68
23	3/4"	653	475	394	345	312	287	251	227	209	194	183	173	165	149	137
31	1"	1571	1126	927	807	725	664	578	520	476	442	415	392	372	334	306
37	1-1/4"	2415	1719	1409	1224	1097	1003	871	781	714	662	620	585	556	498	456
48	1-1/2"	5110	3632	2974	2581	2312	2114	1834	1643	1502	1392	1304	1230	1168	1046	956
60	2"	11314	7915	6423	5538	4936	4493	3874	3453	3144	2904	2711	2551	2416	2154	1960

<b>Table 7-6</b>																
Maximum Capacity of Gastite®/FlashShield™ Flexible Gas Piping in Cubic Feet Per Hour of <b>Natural Gas</b> with a <b>Gas Pressure of 0.5 psi or Less and a Pressure Drop of 4.0"WC</b> (based on a 0.60 specific gravity gas)																
Tubing		Tubing Length (ft)														
EHD	Size	200	250	300	400	500	600	700	800	900	1000	1100	1200	1300	1400	1500
13	3/8"	20	18	16	14	12	11	10	10	9	8	8	8	7	7	7
18	1/2"	59	53	49	42	38	34	32	30	28	27	26	24	24	23	22
23	3/4"	120	108	100	87	79	72	67	63	60	57	55	53	51	49	48
31	1"	267	240	220	191	172	157	146	137	130	123	118	113	109	105	101
37	1-1/4"	396	355	324	282	253	231	214	201	189	180	172	164	158	152	147
48	1-1/2"	830	744	680	590	528	483	448	419	396	376	358	343	330	318	308
60	2"	1690	1507	1372	1183	1054	960	886	827	779	737	702	671	644	620	598

Tables include losses for four 90° bends and two end fittings. Tubing runs with a larger number of bends and/or fittings shall be increased by an equivalent length of tubing to the following equation:  $L=1.3n$  where L is additional length of tubing and n is the number of additional fittings and/or bends.

Table 7-7																
Maximum Capacity of Gastite®/FlashShield™ Flexible Gas Piping in Cubic Feet Per Hour of <b>Natural Gas</b> with a <b>Gas Pressure of 0.5 psi or Less and a Pressure Drop of 5.0"WC</b> (based on a 0.60 specific gravity gas)																
Tubing		Tubing Length (ft)														
EHD	Size	5	10	15	20	25	30	40	50	60	70	80	90	100	125	150
13	3/8"	157	109	88	76	67	61	52	47	42	39	36	34	32	29	26
18	1/2"	409	290	238	206	185	169	146	131	120	111	104	98	93	83	76
23	3/4"	723	526	437	383	345	318	278	251	231	215	202	192	183	165	152
31	1"	1749	1254	1032	898	807	739	644	578	530	492	461	436	415	372	341
37	1-1/4"	2694	1918	1572	1365	1224	1119	972	871	797	739	692	653	620	556	508
48	1-1/2"	5704	4054	3320	2881	2581	2359	2048	1834	1677	1554	1455	1373	1304	1168	1068
60	2"	12692	8880	7205	6213	5538	5041	4346	3874	3527	3257	3041	2862	2711	2416	2199

Table 7-8																
Maximum Capacity of Gastite®/FlashShield™ Flexible Gas Piping in Cubic Feet Per Hour of <b>Natural Gas</b> with a <b>Gas Pressure of 0.5 psi or Less and a Pressure Drop of 6.0"WC</b> (based on a 0.60 specific gravity gas)																
Tubing		Tubing Length (ft)														
EHD	Size	200	250	300	400	500	600	700	800	900	1000	1100	1200	1300	1400	1500
13	3/8"	22	20	18	15	14	13	12	11	10	10	9	9	8	8	8
18	1/2"	66	59	54	47	42	38	36	33	32	30	29	27	26	25	24
23	3/4"	133	120	110	97	87	80	75	70	67	63	61	58	56	54	53
31	1"	297	267	244	213	191	175	163	153	144	137	131	126	121	117	113
37	1-1/4"	441	396	362	314	282	258	239	224	211	201	191	183	176	170	164
48	1-1/2"	926	830	759	658	590	539	500	468	442	419	400	383	368	355	343
60	2"	1896	1690	1539	1327	1183	1077	994	928	874	827	788	753	723	696	671

Table 7-8																
Maximum Capacity of Gastite®/FlashShield™ Flexible Gas Piping in Cubic Feet Per Hour of <b>Natural Gas</b> with a <b>Gas Pressure of 0.5 psi or Less and a Pressure Drop of 6.0"WC</b> (based on a 0.60 specific gravity gas)																
Tubing		Tubing Length (ft)														
EHD	Size	5	10	15	20	25	30	40	50	60	70	80	90	100	125	150
13	3/8"	173	120	97	83	74	67	58	51	47	43	40	38	36	32	29
18	1/2"	447	318	260	226	202	185	160	144	131	122	114	107	102	91	83
23	3/4"	787	572	475	416	376	345	303	273	251	234	220	209	199	179	165
31	1"	1909	1368	1126	981	881	807	703	631	578	537	504	476	452	406	372
37	1-1/4"	2946	2097	1719	1493	1338	1224	1063	953	871	808	757	714	678	608	556
48	1-1/2"	6240	4435	3632	3152	2824	2581	2240	2007	1834	1700	1592	1502	1426	1278	1168
60	2"	13943	9755	7915	6825	6083	5538	4775	4256	3874	3578	3340	3144	2978	2654	2416

Table 7-8																
Maximum Capacity of Gastite®/FlashShield™ Flexible Gas Piping in Cubic Feet Per Hour of <b>Natural Gas</b> with a <b>Gas Pressure of 0.5 psi or Less and a Pressure Drop of 6.0"WC</b> (based on a 0.60 specific gravity gas)																
Tubing		Tubing Length (ft)														
EHD	Size	200	250	300	400	500	600	700	800	900	1000	1100	1200	1300	1400	1500
13	3/8"	25	22	20	17	15	14	13	12	11	11	10	10	9	9	8
18	1/2"	72	65	59	51	46	42	39	37	34	33	31	30	29	28	27
23	3/4"	145	130	120	105	95	87	81	76	72	69	66	63	61	59	57
31	1"	324	291	267	232	209	191	178	167	157	150	143	137	132	127	123
37	1-1/4"	483	433	396	344	308	282	261	245	231	219	209	201	193	186	180
48	1-1/2"	1014	908	830	720	645	590	547	512	483	459	438	419	403	389	376
60	2"	2083	1857	1690	1457	1299	1183	1092	1020	960	909	865	827	794	764	737

Tables include losses for four 90° bends and two end fittings. Tubing runs with a larger number of bends and/or fittings shall be increased by an equivalent length of tubing to the following equation:  $L=1.3n$  where L is additional length of tubing and n is the number of additional fittings and/or bends.

7.2 CSST Capacity Tables - Natural Gas - Elevated Pressure

<b>Table 7-9</b>																
Maximum Capacity of Gastite®/FlashShield™ Flexible Gas Piping in Cubic Feet Per Hour of <b>Natural Gas</b> with a <b>Gas Pressure of 1.0 psi and a Pressure Drop of 13.0"WC</b> (based on a 0.60 specific gravity gas)																
Tubing		Tubing Length (ft)														
EHD	Size	5	10	15	20	25	30	40	50	60	70	80	90	100	125	150
13	3/8"	261	181	146	125	111	101	87	77	70	65	60	57	53	48	43
18	1/2"	655	465	381	330	296	271	235	210	192	178	167	157	149	134	122
23	3/4"	1122	816	677	594	536	493	432	390	358	334	314	297	283	256	235
31	1"	2769	1984	1633	1422	1277	1170	1019	916	839	779	730	690	656	589	540
37	1-1/4"	4304	3064	2511	2181	1955	1788	1553	1392	1273	1180	1105	1043	991	888	812
48	1-1/2"	9134	6491	5316	4613	4133	3778	3279	2937	2685	2489	2330	2199	2087	1870	1709
60	2"	20768	14530	11790	10165	9061	8249	7112	6339	5771	5330	4976	4683	4435	3953	3599

Tubing		Tubing Length (ft)														
EHD	Size	200	250	300	400	500	600	700	800	900	1000	1100	1200	1300	1400	1500
13	3/8"	37	33	30	26	23	21	19	18	17	16	15	14	14	13	13
18	1/2"	106	95	87	75	67	62	57	54	50	48	46	44	42	41	39
23	3/4"	206	186	171	150	135	124	116	109	103	98	94	91	87	84	82
31	1"	470	422	387	337	303	277	258	241	228	217	207	199	191	185	179
37	1-1/4"	705	632	578	502	450	412	382	357	337	320	306	293	282	272	263
48	1-1/2"	1484	1329	1215	1054	945	863	800	749	707	671	640	614	590	569	550
60	2"	3103	2766	2518	2171	1935	1762	1627	1519	1429	1354	1289	1232	1183	1138	1099

<b>Table 7-10</b>																
Maximum Capacity of Gastite®/FlashShield™ Flexible Gas Piping in Cubic Feet Per Hour of <b>Natural Gas</b> with a <b>Gas Pressure of 2.0 psi and a Pressure Drop of 1.0 psi</b> (based on a 0.60 specific gravity gas)																
Tubing		Tubing Length (ft)														
EHD	Size	5	10	15	20	25	30	40	50	60	70	80	90	100	125	150
13	3/8"	392	271	219	188	167	152	130	116	105	97	90	85	80	71	65
18	1/2"	957	679	556	483	432	395	343	307	281	260	243	230	218	195	179
23	3/4"	1596	1161	964	844	762	701	614	554	510	475	447	423	403	364	335
31	1"	4004	2869	2361	2056	1847	1692	1474	1324	1213	1126	1056	998	949	852	781
37	1-1/4"	6269	4463	3658	3177	2848	2604	2262	2027	1854	1719	1610	1520	1443	1294	1183
48	1-1/2"	13331	9474	7758	6733	6032	5514	4785	4287	3918	3632	3401	3209	3047	2729	2495
60	2"	30841	21577	17508	15096	13456	12249	10561	9414	8570	7915	7389	6954	6586	5871	5344

Tubing		Tubing Length (ft)														
EHD	Size	200	250	300	400	500	600	700	800	900	1000	1100	1200	1300	1400	1500
13	3/8"	56	49	45	39	34	31	29	27	25	24	23	22	21	20	19
18	1/2"	155	139	127	110	99	90	83	78	74	70	67	64	62	59	57
23	3/4"	293	265	243	213	193	177	165	155	147	140	134	129	124	120	116
31	1"	680	611	560	487	438	401	372	349	330	314	300	287	277	267	258
37	1-1/4"	1027	921	842	731	656	600	556	521	491	467	445	427	410	396	383
48	1-1/2"	2165	1940	1773	1539	1379	1260	1168	1094	1032	980	935	896	861	830	802
60	2"	4608	4107	3739	3224	2874	2616	2416	2255	2123	2010	1914	1830	1756	1690	1631

Caution: Capacities shown in the elevated pressure tables may exceed the capacity of the line regulator. Refer to Section 4 for Regulator Capacities and Pressure Drops

Tables include losses for four 90° bends and two end fittings. Tubing runs with a larger number of bends and/or fittings shall be increased by an equivalent length of tubing to the following equation:  $L=1.3n$  where L is additional length of tubing and n is the number of additional fittings and/or bends.



**Table 7-11**  
Maximum Capacity of Gastite®/FlashShield™ Flexible Gas Piping in Cubic Feet Per Hour of **Natural Gas**  
with a **Gas Pressure of 5.0 psi and a Pressure Drop of 3.5 psi**  
(based on a 0.60 specific gravity gas)

Tubing		Tubing Length (ft)														
EHD	Size	5	10	15	20	25	30	40	50	60	70	80	90	100	125	150
13	3/8"	760	527	425	365	324	295	253	225	204	188	175	165	156	138	126
18	1/2"	1775	1261	1032	896	802	733	636	570	521	483	452	426	405	363	331
23	3/4"	2838	2064	1713	1501	1355	1246	1092	986	906	844	794	752	717	647	595
31	1"	7311	5239	4312	3755	3373	3090	2691	2417	2214	2056	1929	1822	1732	1556	1426
37	1-1/4"	11587	8248	6761	5872	5263	4813	4180	3747	3426	3177	2976	2809	2667	2391	2186
48	1-1/2"	24713	17563	14382	12482	11182	10221	8871	7947	7264	6733	6304	5949	5648	5060	4625
60	2"	58818	41150	33391	28790	25662	23361	20142	17954	16344	15096	14092	13262	12561	11196	10192

Tubing		Tubing Length (ft)														
EHD	Size	200	250	300	400	500	600	700	800	900	1000	1100	1200	1300	1400	1500
13	3/8"	108	96	87	75	66	60	56	52	49	46	44	42	40	39	37
18	1/2"	287	257	235	204	183	167	155	145	137	130	124	119	114	110	106
23	3/4"	521	471	433	379	342	315	293	276	261	249	238	229	221	213	207
31	1"	1242	1115	1022	890	799	732	680	638	603	573	547	525	505	487	471
37	1-1/4"	1899	1702	1556	1352	1212	1108	1027	962	908	863	823	789	758	731	707
48	1-1/2"	4014	3596	3287	2853	2556	2336	2165	2027	1913	1816	1733	1660	1596	1539	1487
60	2"	8788	7833	7131	6148	5480	4989	4608	4301	4048	3834	3650	3490	3349	3224	3111

Caution: Capacities shown in the elevated pressure tables may exceed the capacity of the line regulator. Refer to Section 4 for Regulator Capacities and Pressure Drops.

**Table 7-12**  
Maximum Capacity of Gastite®/FlashShield™ Flexible Gas Piping in Cubic Feet Per Hour of **Natural Gas**  
with a **Gas Pressure of 10.0 psi and a Pressure Drop of 7.0 psi**  
(based on a 0.60 specific gravity gas)

Tubing		Tubing Length (ft)														
EHD	Size	5	10	15	20	25	30	40	50	60	70	80	90	100	125	150
13	3/8"	1097	760	613	527	468	425	365	324	295	271	253	238	225	200	181
18	1/2"	2499	1775	1453	1261	1129	1032	896	802	733	679	636	600	570	510	466
23	3/4"	3902	2838	2356	2064	1863	1713	1501	1355	1246	1161	1092	1034	986	890	818
31	1"	10201	7311	6016	5239	4707	4312	3755	3373	3090	2869	2691	2543	2417	2171	1989
37	1-1/4"	16276	11587	9498	8248	7394	6761	5872	5263	4813	4463	4180	3945	3747	3359	3071
48	1-1/2"	34773	24713	20237	17563	15734	14382	12482	11182	10221	9474	8871	8370	7947	7120	6508
60	2"	84071	58818	47727	41150	36680	33391	28790	25662	23361	21577	20142	18956	17954	16003	14568

Tubing		Tubing Length (ft)														
EHD	Size	200	250	300	400	500	600	700	800	900	1000	1100	1200	1300	1400	1500
13	3/8"	156	138	126	108	96	87	80	75	70	66	63	60	58	56	54
18	1/2"	405	363	331	287	257	235	218	204	193	183	174	167	161	155	150
23	3/4"	717	647	595	521	471	433	403	379	359	342	328	315	303	293	284
31	1"	1732	1556	1426	1242	1115	1022	949	890	841	799	763	732	705	680	658
37	1-1/4"	2667	2391	2186	1899	1702	1556	1443	1352	1276	1212	1156	1108	1065	1027	993
48	1-1/2"	5648	5060	4625	4014	3596	3287	3047	2853	2692	2556	2438	2336	2246	2165	2093
60	2"	12561	11196	10192	8788	7833	7131	6586	6148	5786	5480	5218	4989	4787	4608	4447

Caution: Capacities shown in the elevated pressure tables may exceed the capacity of the line regulator. Refer to Section 4 for Regulator Capacities and Pressure Drops. \*Gastite's current ANSI LC1/CSA6.26 certificate covers usage up to 5 PSI max. operating pressure. For use at operating pressure greater than 5 PSI, contact Gastite for further guidance.

Tables include losses for four 90° bends and two end fittings. Tubing runs with a larger number of bends and/or fittings shall be increased by an equivalent length of tubing to the following equation:  $L=1.3n$  where L is additional length of tubing and n is the number of additional fittings and/or bends.

7.3 CSST Capacity Tables - Propane Gas

<b>Table 7-13</b>																
Maximum Capacity of Gastite®/FlashShield™ Flexible Gas Piping in Thousands of BTU Per Hour of <b>Liquefied Petroleum Gas</b> with a <b>Gas Pressure of 0.5 psi or Less and a Pressure Drop of 0.5"WC</b> (based on a 1.52 specific gravity LP gas)																
Tubing		Tubing Length (ft)														
EHD	Size	5	10	15	20	25	30	40	50	60	70	80	90	100	125	150
13	3/8"	74	51	41	35	31	29	25	22	20	18	17	16	15	13	12
18	1/2"	208	148	121	105	94	86	75	67	61	57	53	50	47	42	39
23	3/4"	398	290	240	211	190	175	153	138	127	118	111	106	101	91	83
31	1"	917	657	541	471	423	387	337	303	278	258	242	229	217	195	179
37	1-1/4"	1381	983	806	700	627	574	498	446	408	379	355	335	318	285	261
48	1-1/2"	2907	2066	1692	1468	1316	1203	1044	935	855	792	742	700	664	595	544
60	2"	6141	4296	3486	3006	2679	2439	2103	1874	1706	1576	1471	1385	1311	1169	1064

Tubing		Tubing Length (ft)														
EHD	Size	200	250	300	400	500	600	700	800	900	1000	1100	1200	1300	1400	1500
13	3/8"	10	9	8	7	6	6	5	5	5	4	4	4	4	4	4
18	1/2"	34	30	28	24	21	20	18	17	16	15	15	14	13	13	12
23	3/4"	73	66	61	53	48	44	41	39	37	35	33	32	31	30	29
31	1"	156	140	128	112	100	92	85	80	76	72	69	66	63	61	59
37	1-1/4"	226	203	185	161	144	132	122	115	108	103	98	94	90	87	84
48	1-1/2"	472	423	387	336	301	275	255	239	225	214	204	195	188	181	175
60	2"	917	818	744	642	572	521	481	449	423	400	381	364	350	337	325

<b>Table 7-14</b>																
Maximum Capacity of Gastite®/FlashShield™ Flexible Gas Piping in Thousands of BTU Per Hour of <b>Liquefied Petroleum Gas</b> with a <b>Gas Pressure of 0.5 psi or Less and a Pressure Drop of 1.0"WC</b> (based on a 1.52 specific gravity LP gas)																
Tubing		Tubing Length (ft)														
EHD	Size	5	10	15	20	25	30	40	50	60	70	80	90	100	125	150
13	3/8"	106	74	60	51	45	41	35	31	29	26	25	23	22	19	18
18	1/2"	293	208	170	148	132	121	105	94	86	80	75	70	67	60	55
23	3/4"	548	398	331	290	261	240	211	190	175	163	153	145	138	125	115
31	1"	1279	917	754	657	590	541	471	423	387	360	337	319	303	272	249
37	1-1/4"	1940	1381	1132	983	881	806	700	627	574	532	498	470	446	400	366
48	1-1/2"	4091	2907	2381	2066	1851	1692	1468	1316	1203	1115	1044	985	935	838	766
60	2"	8777	6141	4983	4296	3829	3486	3006	2679	2439	2253	2103	1979	1874	1671	1521

Tubing		Tubing Length (ft)														
EHD	Size	200	250	300	400	500	600	700	800	900	1000	1100	1200	1300	1400	1500
13	3/8"	15	13	12	10	9	8	8	7	7	6	6	6	6	5	5
18	1/2"	47	42	39	34	30	28	26	24	23	21	20	20	19	18	18
23	3/4"	101	91	83	73	66	61	57	53	50	48	46	44	43	41	40
31	1"	217	195	179	156	140	128	119	112	105	100	96	92	88	85	82
37	1-1/4"	318	285	261	226	203	185	172	161	152	144	138	132	127	122	118
48	1-1/2"	664	595	544	472	423	387	358	336	317	301	287	275	264	255	246
60	2"	1311	1169	1064	917	818	744	688	642	604	572	545	521	500	481	464

Tables include losses for four 90° bends and two end fittings. Tubing runs with a larger number of bends and/or fittings shall be increased by an equivalent length of tubing to the following equation:  $L=1.3n$  where L is additional length of tubing and n is the number of additional fittings and/or bends.

<b>Table 7-15</b>																
Maximum Capacity of Gastite®/FlashShield™ Flexible Gas Piping in Thousands of BTU Per Hour of <b>Liquefied Petroleum Gas</b> with a <b>Gas Pressure of 0.5 psi or Less and a Pressure Drop of 2.0"WC</b> (based on a 1.52 specific gravity LP gas)																
Tubing		Tubing Length (ft)														
EHD	Size	5	10	15	20	25	30	40	50	60	70	80	90	100	125	150
13	3/8"	154	106	86	74	66	60	51	45	41	38	35	33	31	28	25
18	1/2"	412	293	240	208	186	170	148	132	121	112	105	99	94	84	77
23	3/4"	753	548	454	398	359	331	290	261	240	224	211	200	190	172	158
31	1"	1785	1279	1053	917	824	754	657	590	541	502	471	445	423	380	348
37	1-1/4"	2725	1940	1590	1381	1238	1132	983	881	806	747	700	660	627	562	514
48	1-1/2"	5756	4091	3350	2907	2605	2381	2066	1851	1692	1568	1468	1386	1316	1179	1077
60	2"	12546	8777	7122	6141	5474	4983	4296	3829	3486	3220	3006	2829	2679	2388	2174
Tubing		Tubing Length (ft)														
EHD	Size	200	250	300	400	500	600	700	800	900	1000	1100	1200	1300	1400	1500
13	3/8"	22	19	18	15	13	12	11	10	10	9	9	8	8	8	8
18	1/2"	67	60	55	47	42	39	36	34	32	30	29	28	27	26	25
23	3/4"	138	125	115	101	91	83	78	73	69	66	63	61	59	57	55
31	1"	303	272	249	217	195	179	166	156	147	140	134	128	123	119	115
37	1-1/4"	446	400	366	318	285	261	242	226	214	203	194	185	178	172	166
48	1-1/2"	935	838	766	664	595	544	504	472	446	423	404	387	372	358	346
60	2"	1874	1671	1521	1311	1169	1064	983	917	863	818	779	744	714	688	664

<b>Table 7-16</b>																
Maximum Capacity of Gastite®/FlashShield™ Flexible Gas Piping in Thousands of BTU Per Hour of <b>Liquefied Petroleum Gas</b> with a <b>Gas Pressure of 0.5 psi or Less and a Pressure Drop of 2.5"WC</b> (based on a 1.52 specific gravity LP gas)																
Tubing		Tubing Length (ft)														
EHD	Size	5	10	15	20	25	30	40	50	60	70	80	90	100	125	150
13	3/8"	173	120	97	83	74	67	58	51	46	43	40	37	35	31	29
18	1/2"	460	327	268	232	208	190	165	148	135	125	117	111	105	94	86
23	3/4"	834	607	504	441	398	366	321	290	266	248	233	221	211	190	175
31	1"	1987	1424	1172	1021	917	840	731	657	602	559	524	495	471	423	387
37	1-1/4"	3040	2164	1774	1540	1381	1263	1097	983	899	833	781	737	700	627	574
48	1-1/2"	6426	4567	3740	3245	2907	2658	2306	2066	1889	1751	1639	1547	1468	1316	1203
60	2"	14075	9847	7990	6889	6141	5590	4820	4296	3911	3612	3372	3173	3006	2679	2439
Tubing		Tubing Length (ft)														
EHD	Size	200	250	300	400	500	600	700	800	900	1000	1100	1200	1300	1400	1500
13	3/8"	25	22	20	17	15	14	13	12	11	10	10	10	9	9	8
18	1/2"	75	67	61	53	47	43	40	38	35	34	32	31	30	29	28
23	3/4"	153	138	127	111	101	93	86	81	77	73	70	67	65	63	61
31	1"	337	303	278	242	217	199	185	173	164	156	149	143	137	132	128
37	1-1/4"	498	446	408	355	318	291	270	252	238	226	216	207	199	192	185
48	1-1/2"	1044	935	855	742	664	607	563	527	497	472	451	432	415	400	387
60	2"	2103	1874	1706	1471	1311	1194	1103	1029	969	917	873	835	801	771	744

Tables include losses for four 90° bends and two end fittings. Tubing runs with a larger number of bends and/or fittings shall be increased by an equivalent length of tubing to the following equation:  $L=1.3n$  where L is additional length of tubing and n is the number of additional fittings and/or bends.

Table 7-17																
Maximum Capacity of Gastite®/FlashShield™ Flexible Gas Piping in Thousands of BTU Per Hour of Liquefied Petroleum Gas with a Gas Pressure of 0.5 psi or Less and a Pressure Drop of 3.0"WC (based on a 1.52 specific gravity LP gas)																
Tubing		Tubing Length (ft)														
EHD	Size	5	10	15	20	25	30	40	50	60	70	80	90	100	125	150
13	3/8"	190	132	106	91	81	74	63	56	51	47	44	41	39	35	31
18	1/2"	504	358	293	254	228	208	180	162	148	137	128	121	115	103	94
23	3/4"	907	660	548	480	433	398	349	315	290	270	254	240	229	207	190
31	1"	2169	1554	1279	1114	1001	917	798	717	657	610	572	541	514	462	423
37	1-1/4"	3324	2366	1940	1684	1510	1381	1199	1075	983	911	854	806	765	686	627
48	1-1/2"	7029	4996	4091	3550	3181	2907	2523	2260	2066	1915	1793	1692	1606	1439	1316
60	2"	15461	10817	8777	7568	6746	6141	5295	4719	4296	3968	3704	3486	3302	2943	2679

Table 7-18																
Maximum Capacity of Gastite®/FlashShield™ Flexible Gas Piping in Thousands of BTU Per Hour of Liquefied Petroleum Gas with a Gas Pressure of 2.0 psi or Less and a Pressure Drop of 1.0"PSI (based on a 1.52 specific gravity LP gas)																
Tubing		Tubing Length (ft)														
EHD	Size	200	250	300	400	500	600	700	800	900	1000	1100	1200	1300	1400	1500
13	3/8"	27	24	22	19	17	15	14	13	12	12	11	10	10	10	9
18	1/2"	82	73	67	58	52	47	44	41	39	37	35	34	32	31	30
23	3/4"	167	150	138	121	109	101	94	88	83	80	76	73	71	68	66
31	1"	368	331	303	264	237	217	202	189	179	170	162	156	150	145	140
37	1-1/4"	545	488	446	388	348	318	295	276	261	247	236	226	218	210	203
48	1-1/2"	1142	1023	935	811	727	664	616	577	544	517	493	472	454	438	423
60	2"	2310	2059	1874	1616	1441	1311	1211	1131	1064	1008	960	917	880	847	818

7.4 CSST Capacity Tables - Propane Gas - Elevated Pressure

Table 7-18																
Maximum Capacity of Gastite®/FlashShield™ Flexible Gas Piping in Thousands of BTU Per Hour of Liquefied Petroleum Gas with a Gas Pressure of 2.0 psi or Less and a Pressure Drop of 1.0"PSI (based on a 1.52 specific gravity LP gas)																
Tubing		Tubing Length (ft)														
EHD	Size	5	10	15	20	25	30	40	50	60	70	80	90	100	125	150
13	3/8"	621	430	347	298	265	241	207	184	167	154	143	135	127	113	103
18	1/2"	1516	1077	882	765	685	626	543	487	445	412	386	364	346	310	283
23	3/4"	2530	1840	1527	1338	1208	1111	973	879	808	753	708	671	639	577	530
31	1"	6346	4548	3743	3259	2928	2682	2336	2098	1922	1785	1674	1582	1504	1351	1237
37	1-1/4"	9937	7074	5798	5036	4514	4128	3585	3213	2938	2725	2552	2409	2287	2050	1875
48	1-1/2"	21129	15016	12297	10672	9561	8739	7584	6795	6211	5756	5390	5086	4829	4326	3954
60	2"	48882	34199	27750	23926	21327	19415	16739	14921	13583	12546	11711	11022	10439	9305	8471

Table 7-18																
Maximum Capacity of Gastite®/FlashShield™ Flexible Gas Piping in Thousands of BTU Per Hour of Liquefied Petroleum Gas with a Gas Pressure of 2.0 psi or Less and a Pressure Drop of 1.0"PSI (based on a 1.52 specific gravity LP gas)																
Tubing		Tubing Length (ft)														
EHD	Size	200	250	300	400	500	600	700	800	900	1000	1100	1200	1300	1400	1500
13	3/8"	88	78	71	61	54	49	45	42	40	38	36	34	33	31	30
18	1/2"	246	220	201	174	156	143	132	124	117	111	106	101	97	94	91
23	3/4"	465	420	386	338	305	281	261	246	233	222	212	204	197	190	184
31	1"	1078	968	887	772	694	636	590	553	523	497	475	455	438	423	409
37	1-1/4"	1628	1460	1335	1159	1039	950	881	825	779	740	706	676	650	627	606
48	1-1/2"	3432	3074	2810	2439	2185	1997	1851	1733	1636	1553	1482	1419	1365	1316	1272
60	2"	7303	6510	5926	5110	4555	4146	3829	3575	3364	3186	3034	2901	2783	2679	2586

Tables include losses for four 90° bends and two end fittings. Tubing runs with a larger number of bends and/or fittings shall be increased by an equivalent length of tubing to the following equation: L=1.3n where L is additional length of tubing and n is the number of additional fittings and/or bends.

<b>Table 7-19</b>																
Maximum Capacity of Gastite®/FlashShield™ Flexible Gas Piping in Thousands of BTU Per Hour of <b>Liquefied Petroleum Gas</b> with a <b>Gas Pressure of 5.0 psi</b> and a <b>Pressure Drop of 3.5 psi</b> (based on a 1.52 specific gravity LP gas)																
Tubing		Tubing Length (ft)														
EHD	Size	5	10	15	20	25	30	40	50	60	70	80	90	100	125	150
13	3/8"	1205	835	674	578	514	467	401	356	323	298	278	261	247	219	199
18	1/2"	2814	1999	1636	1420	1272	1162	1008	903	825	765	716	676	641	575	525
23	3/4"	4498	3272	2716	2380	2148	1975	1731	1562	1437	1338	1259	1192	1136	1025	943
31	1"	11588	8305	6834	5952	5346	4898	4265	3831	3510	3259	3057	2888	2746	2467	2260
37	1-1/4"	18365	13074	10717	9307	8342	7629	6625	5939	5431	5036	4716	4452	4228	3790	3465
48	1-1/2"	39170	27837	22796	19783	17724	16201	14060	12596	11514	10672	9992	9429	8952	8020	7331
60	2"	93226	65223	52924	45632	40675	37027	31925	28457	25905	23926	22335	21020	19909	17746	16155

Tubing		Tubing Length (ft)														
EHD	Size	200	250	300	400	500	600	700	800	900	1000	1100	1200	1300	1400	1500
13	3/8"	171	152	138	119	105	96	88	82	77	73	69	66	64	61	59
18	1/2"	456	408	373	324	290	265	246	230	217	206	196	188	181	174	169
23	3/4"	826	746	686	601	542	499	465	437	414	395	378	363	350	338	328
31	1"	1968	1768	1619	1410	1267	1161	1078	1011	955	908	867	832	800	772	747
37	1-1/4"	3010	2698	2467	2142	1920	1756	1628	1525	1440	1367	1305	1250	1202	1159	1121
48	1-1/2"	6362	5699	5210	4521	4051	3703	3432	3213	3032	2879	2747	2631	2530	2439	2357
60	2"	13929	12416	11302	9745	8686	7907	7303	6818	6416	6077	5786	5532	5309	5110	4931

Caution: Capacities shown in the elevated pressure tables may exceed the capacity of the line regulator. Refer to Section 4 for Regulator Capacities and Pressure Drops.

<b>Table 7-20</b>																
Maximum Capacity of Gastite®/FlashShield™ Flexible Gas Piping in Thousands of BTU Per Hour of <b>Liquefied Petroleum Gas</b> with a <b>Gas Pressure of 10.0 psi</b> and a <b>Pressure Drop of 7.0 psi</b> (based on a 1.52 specific gravity LP gas)																
Tubing		Tubing Length (ft)														
EHD	Size	5	10	15	20	25	30	40	50	60	70	80	90	100	125	150
13	3/8"	1738	1205	972	835	742	674	578	514	467	430	401	377	356	317	287
18	1/2"	3961	2814	2303	1999	1790	1636	1420	1272	1162	1077	1008	951	903	809	739
23	3/4"	6185	4498	3734	3272	2953	2716	2380	2148	1975	1840	1731	1640	1562	1410	1297
31	1"	16169	11588	9536	8305	7460	6834	5952	5346	4898	4548	4265	4030	3831	3442	3153
37	1-1/4"	25798	18365	15054	13074	11719	10717	9307	8342	7629	7074	6625	6254	5939	5323	4868
48	1-1/2"	55115	39170	32076	27837	24939	22796	19783	17724	16201	15016	14060	13267	12596	11284	10315
60	2"	133253	93226	75647	65223	58138	52924	45632	40675	37027	34199	31925	30045	28457	25365	23091

Tubing		Tubing Length (ft)														
EHD	Size	200	250	300	400	500	600	700	800	900	1000	1100	1200	1300	1400	1500
13	3/8"	247	219	199	171	152	138	127	119	111	105	100	96	92	88	85
18	1/2"	641	575	525	456	408	373	346	324	305	290	277	265	255	246	237
23	3/4"	1136	1025	943	826	746	686	639	601	569	542	519	499	481	465	450
31	1"	2746	2467	2260	1968	1768	1619	1504	1410	1333	1267	1210	1161	1117	1078	1043
37	1-1/4"	4228	3790	3465	3010	2698	2467	2287	2142	2022	1920	1833	1756	1689	1628	1574
48	1-1/2"	8952	8020	7331	6362	5699	5210	4829	4521	4266	4051	3865	3703	3559	3432	3317
60	2"	19909	17746	16155	13929	12416	11302	10439	9745	9171	8686	8270	7907	7588	7303	7048

Caution: Capacities shown in the elevated pressure tables may exceed the capacity of the line regulator. Refer to Section 4 for Regulator Capacities and Pressure Drops. \*Gastite's current ANSI LC1/CSA6.26 certificate covers usage up to 5 PSI max. operating pressure. For use at operating pressure greater than 5 PSI, contact Gastite for further guidance.

Tables include losses for four 90° bends and two end fittings. Tubing runs with a larger number of bends and/or fittings shall be increased by an equivalent length of tubing to the following equation:  $L=1.3n$  where L is additional length of tubing and n is the number of additional fittings and/or bends.

7.5 Gastite®/FlashShield™ CSST Pressure Drop Per Foot Tables

**Table 7-21 (Sheet 1 of 2)**

Gastite®/FlashShield™ CSST Pressure Drop Tables  
Pressure drop per foot in inches of water column (based on Natural Gas of 0.60 specific gravity)

CFH	3/8"	1/2"	3/4"	1"	1-1/4"	1-1/2"	2"	CFH	3/8"	1/2"	3/4"	1"	1-1/4"	1-1/2"	2"
10	0.005	0.001	0.000	0.000	0.000	0.000	0.000	1000			2.023	0.312	0.133	0.029	0.007
20	0.020	0.002	0.000	0.000	0.000	0.000	0.000	1050			2.250	0.346	0.146	0.032	0.007
30	0.044	0.005	0.001	0.000	0.000	0.000	0.000	1100			2.490	0.381	0.161	0.035	0.008
40	0.075	0.009	0.002	0.000	0.000	0.000	0.000	1150			2.743	0.418	0.176	0.039	0.009
50	0.114	0.014	0.003	0.001	0.000	0.000	0.000	1200			3.009	0.457	0.192	0.042	0.009
60	0.161	0.020	0.004	0.001	0.000	0.000	0.000	1250			3.288	0.497	0.209	0.046	0.010
70	0.216	0.028	0.006	0.001	0.001	0.000	0.000	1300			3.582	0.539	0.226	0.050	0.011
80	0.278	0.037	0.008	0.002	0.001	0.000	0.000	1350			3.888	0.583	0.244	0.054	0.012
90	0.347	0.047	0.011	0.002	0.001	0.000	0.000	1400			4.209	0.629	0.263	0.058	0.013
100	0.424	0.058	0.013	0.003	0.001	0.000	0.000	1450			4.543	0.677	0.283	0.062	0.014
110	0.508	0.070	0.017	0.003	0.001	0.000	0.000	1500			4.891	0.726	0.303	0.066	0.015
120	0.599	0.083	0.020	0.004	0.002	0.000	0.000	1550				0.778	0.324	0.071	0.016
130	0.696	0.098	0.024	0.004	0.002	0.000	0.000	1600				0.831	0.346	0.076	0.017
140	0.801	0.114	0.028	0.005	0.002	0.001	0.000	1650				0.886	0.368	0.081	0.018
150	0.913	0.131	0.033	0.006	0.003	0.001	0.000	1700				0.942	0.391	0.086	0.019
160	1.031	0.149	0.037	0.007	0.003	0.001	0.000	1750				1.001	0.415	0.091	0.020
170	1.156	0.169	0.043	0.008	0.004	0.001	0.000	1800				1.061	0.439	0.096	0.021
180	1.288	0.190	0.048	0.009	0.004	0.001	0.000	1850				1.124	0.465	0.102	0.022
190	1.427	0.212	0.054	0.010	0.004	0.001	0.000	1900				1.188	0.491	0.107	0.023
200	1.572	0.235	0.061	0.011	0.005	0.001	0.000	1950				1.254	0.517	0.113	0.024
225	1.964	0.298	0.079	0.014	0.006	0.001	0.000	2000				1.321	0.545	0.119	0.026
250	2.397	0.369	0.099	0.017	0.008	0.002	0.000	2050				1.391	0.573	0.125	0.027
275	2.870	0.448	0.122	0.021	0.010	0.002	0.001	2100				1.463	0.602	0.132	0.028
300	3.383	0.534	0.147	0.026	0.011	0.003	0.001	2150				1.536	0.631	0.138	0.029
325	3.935	0.628	0.175	0.030	0.013	0.003	0.001	2200				1.611	0.662	0.145	0.031
350	4.527	0.730	0.206	0.035	0.016	0.003	0.001	2250				1.688	0.693	0.151	0.032
375		0.840	0.239	0.041	0.018	0.004	0.001	2300				1.767	0.724	0.158	0.033
400		0.957	0.275	0.046	0.020	0.005	0.001	2350				1.848	0.757	0.165	0.035
425		1.082	0.314	0.053	0.023	0.005	0.001	2400				1.931	0.790	0.173	0.036
450		1.215	0.356	0.059	0.026	0.006	0.001	2450				2.016	0.824	0.180	0.038
475		1.356	0.400	0.066	0.029	0.006	0.002	2500				2.102	0.859	0.187	0.039
500		1.504	0.447	0.074	0.032	0.007	0.002	2550				2.191	0.894	0.195	0.041
525		1.660	0.497	0.082	0.036	0.008	0.002	2600				2.281	0.930	0.203	0.042
550		1.824	0.551	0.090	0.039	0.009	0.002	2650				2.373	0.967	0.211	0.044
600		2.176	0.665	0.108	0.047	0.010	0.002	2700				2.467	1.005	0.219	0.046
625		2.364	0.727	0.118	0.051	0.011	0.003	2750				2.563	1.043	0.227	0.047
650		2.559	0.792	0.127	0.055	0.012	0.003	2800				2.661	1.082	0.236	0.049
675		2.763	0.860	0.138	0.059	0.013	0.003	2850				2.761	1.122	0.245	0.051
700		2.974	0.931	0.149	0.064	0.014	0.003	2900				2.863	1.162	0.253	0.052
725		3.193	1.005	0.160	0.069	0.015	0.004	2950				2.966	1.204	0.262	0.054
750		3.420	1.081	0.172	0.074	0.016	0.004	3000				3.072	1.246	0.271	0.056
775		3.655	1.161	0.184	0.079	0.017	0.004	3050				3.179	1.288	0.281	0.058
800		3.898	1.245	0.196	0.084	0.019	0.004	3100				3.289	1.332	0.290	0.060
825		4.149	1.331	0.209	0.089	0.020	0.005	3150				3.400	1.376	0.300	0.062
850		4.408	1.420	0.223	0.095	0.021	0.005	3200				3.513	1.421	0.309	0.063
875		4.674	1.513	0.237	0.101	0.022	0.005	3250				3.628	1.466	0.319	0.065
900		4.949	1.608	0.251	0.107	0.024	0.005	3300				3.746	1.513	0.329	0.067
925			1.707	0.266	0.113	0.025	0.006	3350				3.865	1.560	0.340	0.069
950			1.809	0.281	0.119	0.026	0.006	3400				3.986	1.608	0.350	0.071
975			1.915	0.296	0.126	0.028	0.006	3450				4.108	1.656	0.360	0.073

Tables include losses for four 90° bends and two end fittings. Tubing runs with a larger number of bends and/or fittings shall be increased by an equivalent length of tubing to the following equation:  $L=1.3n$  where L is additional length of tubing and n is the number of additional fittings and/or bends.



Table 7-21 (Sheet 2 of 2)

Gastite®/FlashShield™ CSST Pressure Drop Tables  
Pressure drop per foot in inches of water column (based on Natural Gas of 0.60 specific gravity)

CFH	3/8"	1/2"	3/4"	1"	1-1/4"	1-1/2"	2"	CFH	3/8"	1/2"	3/4"	1"	1-1/4"	1-1/2"	2"
3500				4.233	1.706	0.371	0.076	6800						1.428	0.274
3550				4.360	1.756	0.382	0.078	6900						1.471	0.282
3600				4.489	1.807	0.393	0.080	7000						1.515	0.290
3650				4.620	1.858	0.404	0.082	7100						1.559	0.298
3700				4.752	1.910	0.415	0.084	7200						1.604	0.306
3750				4.887	1.963	0.427	0.086	7300						1.650	0.315
3800					2.017	0.438	0.089	7400						1.696	0.323
3850					2.072	0.450	0.091	7500						1.743	0.331
3900					2.127	0.462	0.093	7600						1.790	0.340
3950					2.183	0.474	0.096	7700						1.838	0.349
4000					2.240	0.487	0.098	7750						1.863	0.353
4050					2.297	0.499	0.100	7800						1.887	0.358
4100					2.355	0.512	0.103	7900						1.937	0.367
4150					2.414	0.524	0.105	8000						1.987	0.376
4200					2.474	0.537	0.108	8100						2.037	0.385
4250					2.534	0.550	0.110	8200						2.089	0.394
4300					2.596	0.564	0.113	8250						2.115	0.399
4350					2.657	0.577	0.115	8300						2.141	0.404
4400					2.720	0.590	0.118	8400						2.193	0.413
4450					2.784	0.604	0.120	8500						2.247	0.423
4500					2.848	0.618	0.123	8600						2.301	0.432
4550					2.913	0.632	0.126	8700						2.355	0.442
4600					2.978	0.646	0.128	8750						2.383	0.447
4650					3.045	0.661	0.131	8800						2.411	0.452
4700					3.112	0.675	0.134	8900						2.467	0.462
4750					3.180	0.690	0.137	9000						2.523	0.472
4800					3.248	0.704	0.139	9100						2.580	0.482
4850					3.318	0.719	0.142	9200						2.638	0.493
4900					3.388	0.735	0.145	9250						2.667	0.498
4950					3.459	0.750	0.148	9300						2.697	0.503
5000					3.530	0.765	0.151	9400						2.756	0.514
5100					3.676	0.797	0.157	9500						2.816	0.524
5200					3.824	0.829	0.163	9600						2.876	0.535
5300					3.976	0.861	0.169	9700						2.937	0.546
5400					4.130	0.895	0.175	9750						2.968	0.551
5500					4.288	0.929	0.182	9800						2.999	0.557
5600					4.448	0.963	0.188	9900						3.062	0.568
5700					4.612	0.998	0.195	10000						3.125	0.579
5800					4.779	1.034	0.201	10500						3.450	0.637
5900					4.948	1.071	0.208	11000						3.792	0.697
6000						1.108	0.215	11500						4.149	0.760
6100						1.146	0.222	12000						4.524	0.825
6200						1.184	0.229	12500						4.915	0.893
6300						1.223	0.236	13000							0.964
6400						1.263	0.244	13500							1.037
6500						1.303	0.251	14000							1.113
6600						1.344	0.259	14500							1.191
6700						1.386	0.266	15000							1.272

Tables include losses for four 90° bends and two end fittings. Tubing runs with a larger number of bends and/or fittings shall be increased by an equivalent length of tubing to the following equation:  $L=1.3n$  where L is additional length of tubing and n is the number of additional fittings and/or bends.



Table 7-22 (Sheet 1 of 2)

Gastite®/FlashShield™ CSST Pressure Drop Tables  
 Pressure drop per foot in inches of water column (based on LP Gas of 1.52 specific gravity, 2516 BTU<sub>h</sub>/CFH)

CFH	3/8"	1/2"	3/4"	1"	1-1/4"	1-1/2"	2"	CFH	3/8"	1/2"	3/4"	1"	1-1/4"	1-1/2"	2"
10	0.002	0.000	0.000	0.000	0.000	0.000	0.000	1000		2.571	0.796	0.128	0.055	0.012	0.003
20	0.009	0.001	0.000	0.000	0.000	0.000	0.000	1050		2.838	0.885	0.142	0.061	0.014	0.003
30	0.019	0.002	0.000	0.000	0.000	0.000	0.000	1100		3.119	0.979	0.156	0.067	0.015	0.003
40	0.033	0.004	0.001	0.000	0.000	0.000	0.000	1150		3.413	1.079	0.171	0.074	0.016	0.004
50	0.051	0.006	0.001	0.000	0.000	0.000	0.000	1200		3.720	1.184	0.187	0.080	0.018	0.004
60	0.072	0.009	0.002	0.000	0.000	0.000	0.000	1250		4.041	1.294	0.204	0.087	0.019	0.004
70	0.096	0.012	0.002	0.001	0.000	0.000	0.000	1300		4.375	1.409	0.221	0.094	0.021	0.005
80	0.124	0.015	0.003	0.001	0.000	0.000	0.000	1350		4.723	1.530	0.239	0.102	0.022	0.005
90	0.155	0.020	0.004	0.001	0.000	0.000	0.000	1400			1.656	0.258	0.110	0.024	0.006
100	0.189	0.024	0.005	0.001	0.001	0.000	0.000	1450			1.787	0.277	0.118	0.026	0.006
110	0.226	0.029	0.007	0.001	0.001	0.000	0.000	1500			1.924	0.298	0.126	0.028	0.006
120	0.266	0.035	0.008	0.002	0.001	0.000	0.000	1550			2.066	0.319	0.135	0.030	0.007
130	0.310	0.041	0.009	0.002	0.001	0.000	0.000	1600			2.214	0.341	0.144	0.032	0.007
140	0.356	0.048	0.011	0.002	0.001	0.000	0.000	1650			2.368	0.363	0.154	0.034	0.008
150	0.406	0.055	0.013	0.002	0.001	0.000	0.000	1700			2.527	0.386	0.163	0.036	0.008
160	0.459	0.063	0.015	0.003	0.001	0.000	0.000	1750			2.691	0.410	0.173	0.038	0.009
170	0.514	0.071	0.017	0.003	0.001	0.000	0.000	1800			2.861	0.435	0.183	0.040	0.009
180	0.573	0.080	0.019	0.004	0.002	0.000	0.000	1850			3.037	0.461	0.194	0.043	0.010
190	0.635	0.089	0.021	0.004	0.002	0.000	0.000	1900			3.219	0.487	0.205	0.045	0.010
200	0.699	0.099	0.024	0.005	0.002	0.000	0.000	1950			3.406	0.514	0.216	0.047	0.011
225	0.874	0.125	0.031	0.006	0.003	0.001	0.000	2000			3.599	0.542	0.227	0.050	0.011
250	1.066	0.155	0.039	0.007	0.003	0.001	0.000	2050			3.798	0.570	0.239	0.053	0.012
275	1.277	0.188	0.048	0.009	0.004	0.001	0.000	2100			4.003	0.600	0.251	0.055	0.012
300	1.505	0.224	0.058	0.010	0.005	0.001	0.000	2150			4.213	0.630	0.263	0.058	0.013
325	1.751	0.264	0.069	0.012	0.006	0.001	0.000	2200			4.429	0.661	0.276	0.061	0.013
350	2.014	0.306	0.081	0.014	0.006	0.001	0.000	2250			4.651	0.692	0.289	0.063	0.014
375	2.294	0.352	0.094	0.017	0.007	0.002	0.000	2300			4.879	0.725	0.302	0.066	0.015
400	2.592	0.402	0.108	0.019	0.009	0.002	0.000	2350				0.758	0.316	0.069	0.015
425	2.907	0.454	0.124	0.022	0.010	0.002	0.001	2400				0.792	0.330	0.072	0.016
450	3.238	0.510	0.140	0.024	0.011	0.002	0.001	2450				0.826	0.344	0.075	0.016
475	3.587	0.569	0.157	0.027	0.012	0.003	0.001	2500				0.862	0.358	0.079	0.017
500	3.952	0.631	0.176	0.030	0.013	0.003	0.001	2550				0.898	0.373	0.082	0.018
525	4.334	0.697	0.196	0.034	0.015	0.003	0.001	2600				0.935	0.388	0.085	0.018
550	4.732	0.766	0.217	0.037	0.016	0.004	0.001	2650				0.973	0.404	0.088	0.019
575		0.913	0.262	0.044	0.020	0.004	0.001	2700				1.012	0.419	0.092	0.020
600		0.992	0.286	0.048	0.021	0.005	0.001	2750				1.051	0.435	0.095	0.021
625		1.074	0.312	0.052	0.023	0.005	0.001	2800				1.091	0.451	0.099	0.021
650		1.159	0.338	0.057	0.025	0.006	0.001	2850				1.132	0.468	0.102	0.022
675		1.248	0.366	0.061	0.027	0.006	0.001	2900				1.174	0.485	0.106	0.023
700		1.340	0.395	0.066	0.029	0.006	0.001	2950				1.216	0.502	0.110	0.024
725		1.435	0.425	0.070	0.031	0.007	0.002	3000				1.259	0.520	0.114	0.024
750		1.534	0.457	0.075	0.033	0.007	0.002	3050				1.304	0.538	0.118	0.025
775		1.636	0.490	0.081	0.035	0.008	0.002	3100				1.348	0.556	0.122	0.026
800		1.741	0.524	0.086	0.037	0.008	0.002	3150				1.394	0.574	0.126	0.027
825		1.850	0.559	0.091	0.040	0.009	0.002	3200				1.440	0.593	0.130	0.028
850		1.962	0.595	0.097	0.042	0.009	0.002	3250				1.488	0.612	0.134	0.028
860		2.077	0.633	0.103	0.045	0.010	0.002	3300				1.536	0.631	0.138	0.029
875		2.195	0.672	0.109	0.047	0.010	0.002	3350				1.585	0.651	0.142	0.030
900		2.317	0.712	0.115	0.050	0.011	0.002	3400				1.634	0.671	0.147	0.031
925		2.442	0.753	0.122	0.053	0.012	0.002	3450				1.684	0.691	0.151	0.032
950		2.317	0.712	0.115	0.050	0.011	0.003	3500				1.736	0.712	0.156	0.033
975		2.442	0.753	0.122	0.053	0.012	0.003	3550				1.788	0.733	0.160	0.034

Tables include losses for four 90° bends and two end fittings. Tubing runs with a larger number of bends and/or fittings shall be increased by an equivalent length of tubing to the following equation: L=1.3n where L is additional length of tubing and n is the number of additional fittings and/or bends.

**Table 7-22 (Sheet 2 of 2)**

Gastite®/FlashShield™ CSST Pressure Drop Tables  
Pressure drop per foot in inches of water column (based on LP Gas of 1.52 specific gravity, 2516 BTU/h/CFH)

CFH	3/8"	1/2"	3/4"	1"	1-1/4"	1-1/2"	2"	CFH	3/8"	1/2"	3/4"	1"	1-1/4"	1-1/2"	2"
3600				1.840	0.754	0.165	0.035	6900					2.841	0.617	0.123
3650				1.894	0.775	0.169	0.036	7000					2.926	0.635	0.126
3700				1.948	0.797	0.174	0.037	7100					3.012	0.653	0.130
3750				2.004	0.819	0.179	0.038	7200					3.099	0.672	0.133
3800				2.060	0.842	0.184	0.039	7300					3.188	0.691	0.137
3850				2.116	0.864	0.189	0.040	7400					3.277	0.711	0.141
3900				2.174	0.887	0.194	0.041	7500					3.368	0.730	0.144
3950				2.232	0.911	0.199	0.042	7600					3.460	0.750	0.148
4000				2.292	0.935	0.204	0.043	7700					3.554	0.770	0.152
4050				2.352	0.958	0.209	0.044	7750					3.601	0.781	0.154
4100				2.412	0.983	0.214	0.045	7800					3.649	0.791	0.156
4150				2.474	1.007	0.220	0.046	7900					3.745	0.812	0.160
4200				2.536	1.032	0.225	0.047	8000					3.842	0.833	0.164
4250				2.600	1.058	0.231	0.048	8100					3.941	0.854	0.168
4300				2.664	1.083	0.236	0.049	8200					4.041	0.875	0.172
4350				2.728	1.109	0.242	0.050	8250					4.091	0.886	0.174
4400				2.794	1.135	0.247	0.051	8300					4.142	0.897	0.176
4450				2.861	1.162	0.253	0.052	8400					4.244	0.919	0.180
4500				2.928	1.188	0.259	0.054	8500					4.348	0.942	0.184
4550				2.996	1.215	0.265	0.055	8600					4.453	0.964	0.188
4600				3.065	1.243	0.271	0.056	8700					4.559	0.987	0.192
4650				3.135	1.270	0.277	0.057	8750					4.613	0.999	0.195
4700				3.205	1.298	0.283	0.058	8800					4.666	1.010	0.197
4750				3.276	1.327	0.289	0.059	8900					4.775	1.034	0.201
4800				3.349	1.355	0.295	0.061	9000					4.885	1.057	0.206
4850				3.422	1.384	0.301	0.062	9100					4.997	1.081	0.210
4900				3.495	1.414	0.308	0.063	9200						1.106	0.215
4950				3.570	1.443	0.314	0.064	9250						1.118	0.217
5000				3.645	1.473	0.321	0.066	9300						1.130	0.219
5100				3.799	1.534	0.334	0.068	9400						1.155	0.224
5200				3.955	1.596	0.347	0.071	9500						1.180	0.228
5300				4.115	1.659	0.361	0.074	9600						1.205	0.233
5400				4.279	1.724	0.375	0.076	9700						1.231	0.238
5500				4.445	1.789	0.389	0.079	9750						1.244	0.240
5600				4.615	1.856	0.404	0.082	9800						1.257	0.243
5700				4.788	1.924	0.418	0.085	9900						1.283	0.247
5800				4.964	1.994	0.433	0.088	10000						1.309	0.252
5900				4.445	2.065	0.449	0.091	10500						1.446	0.277
6000				4.529	2.137	0.464	0.094	11000						1.589	0.303
6100				4.615	2.210	0.480	0.097	11500						1.739	0.331
6200				4.701	2.284	0.496	0.100	12000						1.896	0.359
6300				4.788	2.360	0.513	0.103	12500						2.060	0.389
6400				4.876	2.437	0.529	0.106	13000						2.230	0.420
6500				4.964	2.516	0.546	0.109	13500						2.408	0.451
6600					2.595	0.563	0.113	14000						2.592	0.485
6700					2.676	0.581	0.116	14500						2.784	0.519
6800					2.758	0.599	0.119	15000						2.982	0.554

Tables include losses for four 90° bends and two end fittings. Tubing runs with a larger number of bends and/or fittings shall be increased by an equivalent length of tubing to the following equation:  $L=1.3n$  where L is additional length of tubing and n is the number of additional fittings and/or bends.

7.6 Iron Pipe Capacity Tables

Table 7-23															
Maximum Capacity of Steel IPS Pipe in Cubic Feet Per Hour with a Gas Pressure of 0.5 psi or Less and a Pressure Drop of 0.5 in. WC (based on a 0.60 specific gravity gas)															
Internal Diameter (in.)	Nominal Iron Pipe Size (in.)	Run Length (ft)													
		10	20	30	40	50	60	70	80	90	100	125	150	175	200
0.364	1/4"	43	29	24	20	18	16	15	14	13	12	11	10	9	8
0.493	3/8"	95	65	52	45	40	36	33	31	29	27	24	22	20	19
0.622	1/2"	175	120	97	82	73	66	61	57	53	50	44	40	37	35
0.824	3/4"	360	250	200	170	151	138	125	118	110	103	93	84	77	72
1.049	1"	680	465	375	320	285	260	240	220	205	195	175	160	145	135
1.38	1-1/4"	1400	950	770	660	580	530	490	460	430	400	360	325	300	280
1.61	1-1/2"	2100	1460	1180	990	900	810	750	690	650	620	550	500	460	430
2.067	2"	3950	2750	2200	1900	1680	1520	1400	1300	1220	1150	1020	950	850	800
2.469	2-1/2"	6300	4350	3520	3000	2650	2400	2250	2050	1950	1850	1650	1500	1370	1280
3.068	3"	11000	7700	6250	5300	4750	4300	3900	3700	3450	3250	2950	2650	2450	2280
4.026	4"	23000	15800	12800	10900	9700	8800	8100	7500	7200	6700	6000	5500	5000	4600

Table reproduced from National Fuel Gas Code NFPA-54.

7.7 Iron Pipe Pressure Drop Per Foot Tables

Table 7-24 (Sheet 1 of 4)							
Steel IPS Pressure Drop Tables							
Pressure drop per foot in inches of water column (based on Natural Gas of 0.60 specific gravity)							
CFH	1/2"	3/4"	1"	1-1/4"	1-1/2"	2"	2-1/2"
10	0.0	0.0	0.0	0.0	0.000	0.000	0.000
20	0.001	0.000	0.000	0.000	0.000	0.000	0.000
30	0.002	0.001	0.000	0.000	0.000	0.000	0.000
40	0.003	0.001	0.000	0.000	0.000	0.000	0.000
50	0.005	0.001	0.000	0.000	0.000	0.000	0.000
60	0.007	0.002	0.001	0.000	0.000	0.000	0.000
70	0.010	0.002	0.001	0.000	0.000	0.000	0.000
80	0.012	0.003	0.001	0.000	0.000	0.000	0.000
90	0.015	0.004	0.001	0.000	0.000	0.000	0.000
100	0.019	0.005	0.001	0.000	0.000	0.000	0.000
110	0.022	0.006	0.002	0.000	0.000	0.000	0.000
120	0.026	0.007	0.002	0.001	0.000	0.000	0.000
130	0.030	0.008	0.002	0.001	0.000	0.000	0.000
140	0.035	0.009	0.003	0.001	0.000	0.000	0.000
150	0.039	0.010	0.003	0.001	0.000	0.000	0.000
160	0.044	0.011	0.004	0.001	0.000	0.000	0.000
170	0.050	0.013	0.004	0.001	0.000	0.000	0.000
180	0.055	0.014	0.004	0.001	0.001	0.000	0.000
190	0.061	0.016	0.005	0.001	0.001	0.000	0.000
200	0.067	0.017	0.005	0.001	0.001	0.000	0.000
225	0.083	0.021	0.007	0.002	0.001	0.000	0.000
250	0.101	0.026	0.008	0.002	0.001	0.000	0.000
275	0.121	0.031	0.010	0.003	0.001	0.000	0.000
300	0.142	0.036	0.011	0.003	0.001	0.000	0.000
325	0.164	0.042	0.013	0.003	0.002	0.000	0.000
350	0.189	0.048	0.015	0.004	0.002	0.001	0.000
375	0.214	0.055	0.017	0.004	0.002	0.001	0.000
400	0.241	0.062	0.019	0.005	0.002	0.001	0.000
425	0.270	0.069	0.021	0.006	0.003	0.001	0.000
450	0.300	0.077	0.024	0.006	0.003	0.001	0.000
475	0.332	0.085	0.026	0.007	0.003	0.001	0.000
500	0.365	0.093	0.029	0.008	0.004	0.001	0.000
525	0.399	0.102	0.032	0.008	0.004	0.001	0.000
550	0.435	0.111	0.034	0.009	0.004	0.001	0.001
575	0.472	0.121	0.037	0.010	0.005	0.001	0.001
600	0.511	0.131	0.041	0.011	0.005	0.002	0.001
625	0.551	0.141	0.044	0.012	0.005	0.002	0.001
650	0.592	0.151	0.047	0.012	0.006	0.002	0.001
675	0.635	0.162	0.050	0.013	0.006	0.002	0.001
700	0.679	0.174	0.054	0.014	0.007	0.002	0.001
725	0.724	0.185	0.057	0.015	0.007	0.002	0.001
750	0.771	0.197	0.061	0.016	0.008	0.002	0.001
775	0.820	0.210	0.065	0.017	0.008	0.002	0.001
800	0.869	0.222	0.069	0.018	0.009	0.003	0.001

Tables calculated from National Fuel Gas Code NFPA-54 tables. 7.7

Table 7-24 (Sheet 2 of 4)							
Steel IPS Pressure Drop Tables							
Pressure drop per foot in inches of water column (based on Natural Gas of 0.60 specific gravity)							
CFH	1/2"	3/4"	1"	1-1/4"	1-1/2"	2"	2-1/2"
825	0.920	0.235	0.073	0.019	0.009	0.003	0.001
850	0.972	0.249	0.077	0.020	0.010	0.003	0.001
875	1.026	0.262	0.081	0.022	0.010	0.003	0.001
900	1.080	0.276	0.086	0.023	0.011	0.003	0.001
925	1.137	0.291	0.090	0.024	0.011	0.003	0.001
950	1.194	0.305	0.095	0.025	0.012	0.004	0.001
975	1.253	0.320	0.099	0.026	0.012	0.004	0.002
1000	1.313	0.336	0.104	0.028	0.013	0.004	0.002
1050	1.437	0.367	0.114	0.030	0.014	0.004	0.002
1100	1.566	0.400	0.124	0.033	0.016	0.005	0.002
1150	1.700	0.435	0.135	0.036	0.017	0.005	0.002
1200	1.839	0.470	0.146	0.039	0.018	0.005	0.002
1250	1.983	0.507	0.157	0.042	0.020	0.006	0.002
1300	2.132	0.545	0.169	0.045	0.021	0.006	0.003
1350	2.286	0.585	0.181	0.048	0.023	0.007	0.003
1400	2.445	0.625	0.194	0.051	0.024	0.007	0.003
1450	2.609	0.667	0.207	0.055	0.026	0.008	0.003
1500	2.778	0.710	0.220	0.058	0.028	0.008	0.003
1550	2.951	0.755	0.234	0.062	0.029	0.009	0.004
1600	3.130	0.800	0.248	0.066	0.031	0.009	0.004
1650	3.313	0.847	0.263	0.070	0.033	0.010	0.004
1700	3.501	0.895	0.278	0.073	0.035	0.010	0.004
1750	3.693	0.945	0.293	0.078	0.037	0.011	0.005
1800	3.891	0.995	0.309	0.082	0.039	0.012	0.005
1850	4.093	1.047	0.325	0.086	0.041	0.012	0.005
1900	4.300	1.100	0.341	0.090	0.043	0.013	0.005
1950	4.511	1.154	0.358	0.095	0.045	0.013	0.006
2000	4.727	1.209	0.375	0.099	0.047	0.014	0.006
2050	4.948	1.266	0.393	0.104	0.049	0.015	0.006
2100	5.173	1.323	0.410	0.109	0.051	0.015	0.006
2150	5.403	1.382	0.429	0.113	0.054	0.016	0.007
2200	5.638	1.442	0.447	0.118	0.056	0.017	0.007
2250	5.877	1.503	0.466	0.123	0.058	0.017	0.007
2300	6.121	1.565	0.486	0.128	0.061	0.018	0.008
2350	6.369	1.629	0.505	0.134	0.063	0.019	0.008
2400	6.622	1.694	0.525	0.139	0.066	0.020	0.008
2450	6.879	1.759	0.546	0.144	0.068	0.020	0.009
2500	7.141	1.826	0.567	0.150	0.071	0.021	0.009
2550	7.407	1.894	0.588	0.155	0.074	0.022	0.009
2600	7.677	1.964	0.609	0.161	0.076	0.023	0.010
2650	7.953	2.034	0.631	0.167	0.079	0.024	0.010
2700	8.232	2.105	0.653	0.173	0.082	0.024	0.010
2750	8.516	2.178	0.676	0.179	0.085	0.025	0.011
2800	8.805	2.252	0.699	0.185	0.088	0.026	0.011

Tables calculated from National Fuel Gas Code NFPA-54 tables.

Table 7-24 (Sheet 3 of 4)							
Steel IPS Pressure Drop Tables							
Pressure drop per foot in inches of water column (based on Natural Gas of 0.60 specific gravity)							
CFH	1/2"	3/4"	1"	1-1/4"	1-1/2"	2"	2-1/2"
2850	9.097	2.327	0.722	0.191	0.090	0.027	0.011
2900	9.395	2.403	0.745	0.197	0.093	0.028	0.012
2950	9.696	2.480	0.769	0.204	0.096	0.029	0.012
3000	10.002	2.558	0.794	0.210	0.099	0.030	0.013
3050	10.312	2.638	0.818	0.216	0.103	0.031	0.013
3100	10.627	2.718	0.843	0.223	0.106	0.031	0.013
3150	10.946	2.800	0.868	0.230	0.109	0.032	0.014
3200	11.269	2.882	0.894	0.237	0.112	0.033	0.014
3250	11.597	2.966	0.920	0.243	0.115	0.034	0.015
3300	11.929	3.051	0.946	0.250	0.119	0.035	0.015
3350	12.265	3.137	0.973	0.257	0.122	0.036	0.015
3400	12.606	3.224	1.000	0.265	0.125	0.037	0.016
3450	12.951	3.312	1.028	0.272	0.129	0.038	0.016
3500	13.300	3.402	1.055	0.279	0.132	0.039	0.017
3550	13.653	3.492	1.083	0.287	0.136	0.040	0.017
3600		3.583	1.112	0.294	0.139	0.041	0.018
3650		3.676	1.140	0.302	0.143	0.043	0.018
3700		3.770	1.169	0.309	0.147	0.044	0.018
3750		3.864	1.199	0.317	0.150	0.045	0.019
3800		3.960	1.228	0.325	0.154	0.046	0.019
3850		4.057	1.258	0.333	0.158	0.047	0.020
3900		4.155	1.289	0.341	0.161	0.048	0.020
3950		4.254	1.320	0.349	0.165	0.049	0.021
4000		4.354	1.351	0.357	0.169	0.050	0.021
4050		4.455	1.382	0.366	0.173	0.052	0.022
4100		4.557	1.414	0.374	0.177	0.053	0.022
4150		4.660	1.446	0.382	0.181	0.054	0.023
4200		4.765	1.478	0.391	0.185	0.055	0.023
4250		4.870	1.511	0.400	0.189	0.056	0.024
4300		4.976	1.544	0.408	0.193	0.058	0.024
4350		5.084	1.577	0.417	0.198	0.059	0.025
4400		5.193	1.611	0.426	0.202	0.060	0.025
4450		5.302	1.645	0.435	0.206	0.061	0.026
4500		5.413	1.679	0.444	0.210	0.063	0.026
4550		5.524	1.714	0.453	0.215	0.064	0.027
4600		5.637	1.749	0.463	0.219	0.065	0.028
4650		5.751	1.784	0.472	0.224	0.067	0.028
4700		5.866	1.820	0.481	0.228	0.068	0.029
4750		5.982	1.856	0.491	0.233	0.069	0.029
4800		6.099	1.892	0.501	0.237	0.071	0.030
4850		6.216	1.928	0.510	0.242	0.072	0.030
4900		6.335	1.965	0.520	0.246	0.073	0.031

Tables calculated from National Fuel Gas Code NFPA-54 tables.

Table 7-24 (Sheet 4 of 4)							
Steel IPS Pressure Drop Tables							
Pressure drop per foot in inches of water column (based on Natural Gas of 0.60 specific gravity)							
CFH	1/2"	3/4"	1"	1-1/4"	1-1/2"	2"	2-1/2"
4950		6.455	2.003	0.530	0.251	0.075	0.032
5000		6.577	2.040	0.540	0.256	0.076	0.032
5100		6.822	2.116	0.560	0.265	0.079	0.033
5200		7.071	2.194	0.580	0.275	0.082	0.035
5300		7.324	2.272	0.601	0.285	0.085	0.036
5400		7.582	2.352	0.622	0.295	0.088	0.037
5500		7.843	2.433	0.644	0.305	0.091	0.038
5600		8.109	2.516	0.666	0.315	0.094	0.040
5700		8.379	2.599	0.688	0.326	0.097	0.041
5800		8.652	2.684	0.710	0.336	0.100	0.042
5900		8.930	2.770	0.733	0.347	0.103	0.044
6000		9.212	2.858	0.756	0.358	0.107	0.045
6100		9.498	2.946	0.780	0.369	0.110	0.046
6200		9.788	3.036	0.803	0.380	0.113	0.048
6300		10.081	3.127	0.827	0.392	0.117	0.049
6400		10.379	3.220	0.852	0.403	0.120	0.051
6500		10.681	3.313	0.877	0.415	0.124	0.052
6600		10.987	3.408	0.902	0.427	0.127	0.054
6700		11.296	3.504	0.927	0.439	0.131	0.055
6800		11.610	3.602	0.953	0.451	0.134	0.057
6900		11.927	3.700	0.979	0.464	0.138	0.058
7000		12.249	3.800	1.005	0.476	0.142	0.060
7100		12.574	3.901	1.032	0.489	0.146	0.061
7200		12.904	4.003	1.059	0.502	0.149	0.063
7300		13.237	4.106	1.086	0.515	0.153	0.065
7400		13.574	4.211	1.114	0.528	0.157	0.066
7500			4.317	1.142	0.541	0.161	0.068
7750			4.586	1.213	0.575	0.171	0.072
8000			4.864	1.287	0.609	0.181	0.077
8250			5.148	1.362	0.645	0.192	0.081
8500			5.440	1.439	0.682	0.203	0.086
8750			5.740	1.519	0.719	0.214	0.090
9000			6.046	1.600	0.758	0.226	0.095
9250			6.361	1.683	0.797	0.237	0.100
9500			6.682	1.768	0.837	0.249	0.105
9750			7.011	1.855	0.878	0.262	0.111
10000			7.346	1.944	0.921	0.274	0.116
11000			8.762	2.318	1.098	0.327	0.138
12000			10.291	2.723	1.289	0.384	0.162
13000			11.931	3.157	1.495	0.445	0.188
14000			13.683	3.620	1.715	0.511	0.216
15000				4.113	1.948	0.580	0.245

Tables calculated from National Fuel Gas Code NFPA-54 tables.



7.8 Reference Data

Table 7-25					
Pressure Conversion Factors			Fuel Gas Information		
1/4 psi =	6.921 in. w.c. =	(approx. 7" w.c.)		Natural Gas	Propane
1/2 psi =	13.842 in. w.c. =	(approx. 14" w.c.)	BTU per Cubic Foot =	1000	2516
1 psi =	27.684 in. w.c. =	(approx. 28" w.c.)	Specific Gravity =	0.60	1.52
2 psi =	55.368 in. w.c. =	(approx. 56" w.c.)	Note: "Pressure Drop Curves for Gastite®/FlashShield CSST" are expressed in terms of Cubic Feet per Hour (CFH). To determine the CFH for Natural Gas, divide the BTU load by 1000. To determine the CFH for Propane, divide the BTU load by 2516.		
5 psi =	138.42 in. w.c. =	(approx. 140" w.c.)			

Table 7-26			
Pressure Conversion Factors		Fuel Gas Information	
<p>Gas piping systems that are to be supplied with gas of a specific gravity other than 0.60 shall apply a specific gravity factor. The conversion is accomplished by multiplying the capacities given in the tables, charts and graphs by the appropriate multiplier from the table below. In case the exact specific gravity does not appear in the table, choose the next higher value shown. Check with the local gas utility or supplier for the correct specific gravity.</p> <p>Options:</p> <ol style="list-style-type: none"> <li>Using Table A-5 the flow capacity of 1/2" CSST at 50 ft, for natural gas with a specific gravity of 0.60 is 266 CFH. At a specific gravity of 0.65 the resultant value in the table will be 255 CFH (266 x 0.96).</li> </ol> <p>or</p> <ol style="list-style-type: none"> <li>A furnace rated at 80,000 BTUH natural gas with a specific gravity of 0.60 will be rated at 76,800 BTUH natural gas with a specific gravity of 0.65 (80,000/0.96).</li> </ol>			
Specific Gravity	Multiplier	Specific Gravity	Multiplier
0.35	1.31	1.00	0.78
0.40	1.23	1.10	0.74
0.45	1.16	1.20	0.71
0.50	1.10	1.30	0.68
0.55	1.04	1.40	0.66
0.60	1.00	1.50	0.63
0.65	0.96	1.60	0.61
0.70	0.93	1.70	0.59
0.75	0.90	1.80	0.58
0.80	0.87	1.90	0.56
0.85	0.84	2.00	0.55
0.90	0.82	2.10	0.54

## SECTION 8.0 DEFINITIONS

**APPLIANCE (EQUIPMENT)** – Any device which utilizes gas as a fuel or raw material to produce light, heat, power, refrigeration or air conditioning.

**APPROVED** – Acceptable to the authority having jurisdiction.

**AUTHORITY HAVING JURISDICTION** – The organization, office or individual responsible for “approving” equipment, an installation or procedure.

**BONDING (BONDED)** – The permanent joining of metallic parts to form an electrically conductive path that ensures electrical continuity and the capacity to conduct safely any current likely to be imposed. As per the National Electrical Code.

**CAPACITY, FLOW** – As used in this standard, the amount of a specified gas that will flow through a specific length and configuration of tubing, a manifold, fitting or other component at a specified pressure drop in a fixed period of time.

**CONCEALED GAS TUBING** – Gas tubing, which, when in place in a finished building, would require removal of permanent construction to gain access to the piping.

**CONNECTOR, GAS APPLIANCE** – A factory-fabricated assembly of gas conduit and related fittings designed to convey gaseous fuel, and used for making connections between a gas supply piping outlet and the gas to an appliance. It is equipped at each end for attachment to standard taper pipe threads.

**DIRECT BONDING** – Bonding, as above, where the electrical connection is made using a clamp and wire at the piping connected directly to the electrical panel. Refer to Section 4.10 Electrical Bonding of Gastite®/FlashShield™ CSST.

**EFFECTIVE GROUND-FAULT CURRENT PATH** – An intentionally constructed, permanent, low impedance electrically conductive path designed and intended to carry under ground fault conditions from the point of a ground fault on a wiring system to the electrical supply source.

**EQUIVALENT HYDRAULIC DIAMETER (EHD)** – A theoretical size, which reflects the hydraulic performance of the tubing. It is not true physical measurement.

**EXPOSED GAS TUBING** – Gas tubing which will be in view in the finished structure.

**FUEL GAS** – A commonly distributed gas used for fuel such as natural gas, manufactured gas, undiluted liquefied petroleum gas (vapor phase only), liquefied petroleum gas-air mixtures of these gases (includes propane and butane).

**GAS UTILIZATION EQUIPMENT** – Any device that utilizes gas as a fuel or raw material or both.

**INCHES OF WATER COLUMN ("WC)** – Method of pressure measured in inches of water column by a manometer or pressure gauge. Commonly used in the gas industry when the pressure is less than 1 PSI.

**LEAK TEST SOLUTION** – A solution of commercial leak-testing fluids may be used. The use of soap buds or household detergents and water is not considered a satisfactory leak-test fluid for a bubble test, because of a lack of sensitivity due to masking by foam. The fluid should be capable of being applied free of bubbles so that a bubble appears only at a leak. The fluid selected should not bubble except in response to a leak.

**LISTED** – Equipment or materials including a list published by an organization acceptable to the authority having jurisdiction and concerned with product evaluation that maintains periodic inspection of production of listed equipment or materials and whose listing states either that the equipment or materials meets appropriate standards or has been tested and found suitable for use in a specified manner.

**LOCKUP PRESSURE, REGULATOR** – The system pressure, immediately downstream of the regulator, at which the regulator valve will completely close (leak tight) under no-flow conditions to prevent the downstream pressure from exceeding a predetermined level.

**MAXIMUM ACTUAL OPERATING PRESSURE** – The maximum pressure existing in a piping system during a normal annual operating cycle.

**OVER-PRESSURE PROTECTION DEVICE (OPD)** – System component that is intended to protect all downstream components from high pressures in the event of a system failure. OPDs are required in gas systems using more than 2psi line pressure.

**PIPING SYSTEM** – As used in this standard, an assembly of corrugated stainless steel tubing and tubing connection fittings, intended for field assembly and installation in residential or commercial buildings to distribute fuel gas to gas utilization equipment within the building. The piping system may also include a gas pressure regulator(s), a shutoff valve(s), tube shielding devices, distribution manifold(s), and other approved devices or components.

**PLENUM** – A plenum is an enclosed portion of the building structure that is designed to allow air movement, and thereby serve as part of an air distribution system.

**PRESSURE DROP** – The loss in static pressure of flowing fuel gas due to friction or other flow resistance in tubing, fittings, valves, regulators, or other devices in the piping system.

**QUALIFIED INSTALLER** – Any individual, firm, corporation or company which either in person or through a representative is engaged in and is responsible for the installation or replacement of building gas piping systems, who is experienced in such work, familiar with all precautions required, and has complied with all the requirements of the authority having jurisdiction.

**QUICK-DISCONNECT DEVICE** – A hand-operated device which provides a means for connecting and disconnecting an appliance or an appliance connector to a gas supply, and which is equipped with an automatic means to shut off the gas supply when the device is disconnected.

**REGULATOR, PRESSURE** – A device placed in a gas line for reducing, controlling and maintaining the pressure in that portion of the piping system downstream of the device.

**SHIELDING DEVICE** – A component of the piping system used to protect the installed corrugated tubing from accidental puncture by nails, screws or similar hardware at concealed tubing support points.

**STRIKER PLATE** – A special type of shielding device used when concealed tubing is run through wall studs, floor and ceiling joists or other structural members where tubing movement is restricted.

**VALVE, SHUTOFF** – A device used in piping to control the gas supply to any section of the piping system or to an appliance.

# SECTION 9: DIMENSIONAL AND TECHNICAL REFERENCE DATA

## 9.1 Gastite® Dimensional and Technical Reference Data

Gastite Part Number	S93-6A	S93-8A	S93-11B	S93-16A	S93-20A	S93-24A	S93-32A
Size	(3/8")	(1/2")	(3/4")	(1")	(1-1/4")	(1-1/2")	(2")
Equivalent Hydraulic Diameter (EHD)	13	18	23	31	37	48	60
Nominal Diameter	0.375	0.5	0.75	1	1.25	1.5	2
Inside Nominal Diameter	0.39	0.57	0.75	1.04	1.25	1.5	2
Outside Nominal Diameter (w/o jacket)	0.51	0.71	0.93	1.25	1.5	1.74	2.32
Outside Nominal Diameter (w/jacket)	0.56	0.76	0.98	1.3	1.55	1.79	2.4
Convolution Height	0.045	0.06	0.077	0.106	0.112	0.123	0.16
Pitch (Convolutions per foot)	75	65	50	48	45	45	42
Length Of Reels	125-500	125-500	125-500	150-500	150-500	150-300	150-300
Weight of Tubing (lbs./ft)	0.069	0.094	0.123	0.193	0.254	0.36	0.572
Wall Thickness	0.01	0.01	0.01	0.01	0.011	0.012	0.012

Gastite Part Number	XRFTG-6	XRFTG-8	XRFTG-11	XRFTG-16	XRFTG-20	XRFTG-24	XRFTG-32
Size	(3/8")	(1/2")	(3/4")	(1")	(1-1/4")	(1-1/2")	(2")
Pipe Thread	1/2"	1/2"	3/4"	1"	1 1/4"	1-1/2"	2"
Hex Size – Adapter/Nut	.875 / 1.00	1.125 / 1.250	1.375 / 1.500	1.625 / 1.750	2.000 / 2.125	2.500 / 2.750	3.062/3.375
Weight (Lbs.)	0.27	0.36	0.52	0.64	1.2	2.6	4
Overall Length	1.925	2	2.125	2.375	2.75	2.75	3.5

Gastite Part Number	XRTRM-6	XRTRM-8	XRTRM-11	XRTRM-16	XRTRM-20	XRTRM-24	XRTRM-32
Size	(3/8")	(1/2")	(3/4")	(1")	(1-1/4")	(1-1/2")	(2")
Pipe Thread	1/2"	1/2"	3/4"	1"	1-1/4"	1-1/2"	2"
Flange Thread	1/2"	3/4"	1"	1-1/4"	1-1/2"	2"	2-1/2"
Flange Outside Diameter	2-1/2"	2-1/2"	3"	3"	4"	5-5/8"	N/A
Mounting Hole Pattern Diameter	3-1/2"	3-1/2"	4"	4"	3"	4-1/4"	N/A
Weight (Lbs.)	0.92	0.87	1.6	1.7	1.9	2.25	N/A

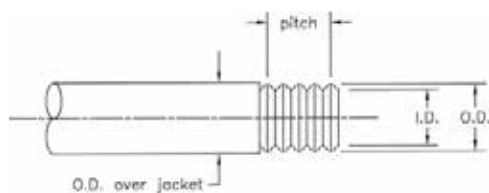

Fig. 9-1

1) Corrugated tubing – 304 Stainless Steel ASTM A240
2) Jacketing – Flame Retarding Polyethylene ASTM E84; 25/20
3) Adapter – CA360 Brass
4) Split Bushing – CA360 Brass
5) Nut – CA360 Brass
6) Termination Nut – CA360 Brass
7) Flange – Malleable Iron (common railing flange), Zinc Plated, Cast Bronze

Fig. 9-2

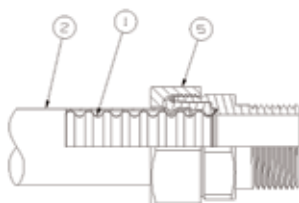

Fig. 9-3

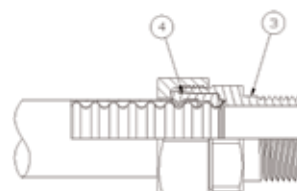
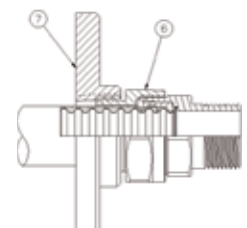

Fig. 9-4



## 9.2 FlashShield™ Dimensional and Technical Reference Data

<b>FlashShield™ Corrugated Stainless Steel Tubing – Dimensional Values (Fig. 9-1)</b>				
FlashShield™ Part Number	FS-8	FS-11	FS-16	FS-20
Size	(1/2")	(3/4")	(1")	(1-1/4")
Equivalent Hydraulic Diameter (EHD)	18	23	31	37
Nominal Diameter	0.5	0.75	1	1.25
Inside Nominal Diameter	0.57	0.75	1.04	1.25
Outside Nominal Diameter (w/o jacket)	0.71	0.93	1.25	1.50
Outside Nominal Diameter (w/jacket)	0.82	1.02	1.36	1.61
Convolution Height	0.06	0.077	0.106	0.112
Pitch (Convolution Per Foot)	65	50	48	45
Length of Reels	125-500	125-500	125-500	150-500
Weight of Tubing (lbs./ft- with jacket)	0.166	0.209	0.307	0.386
Wall Thickness	0.01	0.01	0.01	0.011

<b>FlashShield™ Series Straight Fitting – Dimensional Values</b>				
FlashShield™ Part Number	FSFTG-8	FSFTG-11	FSFTG-16	FSFTG-20
Size	(1/2")	(3/4")	(1")	(1-1/4")
Pipe Thread (NPT)	1/2"	3/4"	1"	1-1/4"
Hex Size – Adapter	1-1/8	1-3/8	1-3/4	2-1/16
Hex Size – Nut	1-1/4	1-9/16	1-15/16	2-3/16
Weight (lbs.)	0.266	0.409	0.608	0.96
Overall Length	1.7	1.85	1.88	2.2

<b>FlashShield™ Series Termination Fitting – Dimensional Values</b>				
FlashShield™ Part Number	FSTRM-8	FSTRM-11	FSTRM-16	FSTRM-20
Size	(1/2")	(3/4")	(1")	(1-1/4")
Pipe Thread (NPT)	1/2"	3/4"	1"	1-1/4"
Flange Thread (NPT)	3/4"	1"	1-1/4"	1-1/2"
Square Flange Outside Dimension	2-5/8"	2-5/8"	2-5/8"	3-1/4"
Mounting Hole Pattern Diameter	2-3/4"	2-3/4"	2-3/4"	3-1/4"

## Temperature Limits - Jacket

Melting Point: 205°F

Minimum Operating Temp: -35°F

Maximum Operating Temp: 160°F

Jacket - Tri-layer polymer and metal with flame retardant meets the testing requirements of ASTM E84 25/50

# GASTITE® SPECIFICATION SHEET

All System Components are CSA Approved

## System Performance

### Pressure Rating

Tubing:

Maximum Approved Operating Pressure		25 psi
Tubing Minimum Burst Pressure		1500 psi
Maximum Test Pressure	3/8", 1/2" & 3/4":	150 psi
	1":	125 psi
	1-1/4":	100 psi
	1-1/2":	50 psi
	2":	40 psi

### Temperature Limits

Tubing:

Melting Point	2400°F
Minimum Operating Temp (w/o regulator):	-40°F (-100°F)
Maximum Operating Temp (w/o regulator):	205°F (400°F)

Jacket:

Melting Point:	350°F
Minimum Operating Temp:	-100°F
Maximum Operating Temp:	200°F

## System Materials

### Corrugated Stainless Steel Tubing

Tubing:	ASTM A240 Type 304 Stainless Steel
Jacket:	Polyethylene with Flame Retardant, ASTM E84 Compliant 25/50

### Fitting Material

Mechanical Joint Fitting:	
Adapter:	CA360 Brass
Nut:	CA360 Brass
Split Bushings:	CA360 Brass
Termination Fitting:	
Adapter:	CA360 Brass
Nut:	CA360 Brass
Split Bushing:	CA360 Brass
Flange:	Square Flange - Steel with Zinc Coating

### Protection Devices

Striker Plates:	16 Gage AISI 1050 Carbon Steel Hardened to Rc 45 with Black Oil and Phosphate Coating
Floppy Conduit:	Strip Wound Interlocking Steel (Heavy Wall)

### Accessories

Valves:	Meet requirements of ANSI/ASME B16.33 (125 psi) or AGA 3-88 (5 psi)
Regulators:	Gas line pressure regulator std. ANSI/CGA Z21.80, CGA-6.22 with vent limiting device
Manifolds Cast:	ASTM A47 32510 Malleable Iron
	Welded: Welded IPS Schedule 40

# FLASHSHIELD™ SPECIFICATION SHEET

All System Components are CSA Approved

## System Performance

### Pressure Rating

#### Tubing:

Maximum Approved Operating Pressure	25 psi
Tubing Minimum Burst Pressure	1500 psi
Maximum Test Pressure	3/8", 1/2" & 3/4": 150 psi
	1": 125 psi
	1-1/4": 100 psi

### Temperature Limits

#### Tubing:

Melting Point	2400°F
Minimum Operating Temp (w/o regulator):	-40°F (-100°F)
Maximum Operating Temp (w/o regulator):	205°F (400°F)

#### Jacket:

Melting Point:	205°F
Minimum Operating Temp:	-35°F
Maximum Operating Temp:	160°F

## System Materials

### Corrugated Stainless Steel Tubing

#### Tubing:

ASTM A240 Type 304 Stainless Steel

#### Jacket:

Flame and Smoke Retardant meet requirements of ASTM E84 25/50

### Fitting Material

#### Mechanical Joint Fitting:

##### Adapter:

CA360 Brass

##### Nut:

CA360 Brass

##### Split Bushings:

CA360 Brass

### Protection Devices

#### Striker Plates:

16 Gage AISI 1050 Carbon Steel Hardened to Rc 45 with Black Oil and Phosphate Coating

#### Floppy Conduit:

Strip Wound Interlocking Steel (Heavy Wall)

### Accessories

#### Valves:

Meet requirements of ANSI/ASME B16.33 (125 psi) or AGA 3-88 (5 psi)

#### Regulators:

Gas line pressure regulator std. ANSI/CGA Z21.80, CGA-6.22 with vent limiting device

#### Manifolds Cast:

ASTM A47 32510 Malleable Iron

Welded: Welded IPS Schedule 40



## SECTION 10.0 WARRANTY

### WARRANTY GASTITE® FLEXIBLE GAS PIPING SYSTEM FLASHSHIELD™ FLEXIBLE GAS PIPING SYSTEM

Gastite Division warrants its products to be free from any defect of workmanship and material. Should any such defects be discovered, the questionable product must be returned to Gastite Division. If, upon inspection, the part proves to be defective, Gastite Division will furnish a replacement, or, at its option, repair the part.

This warranty shall not apply to any part or parts of the Gastite®/FlashShield™ Flexible Gas Piping System product if it has been installed, altered, repaired or misused, through negligence or otherwise, in a way that in the opinion of Gastite Division affects the reliability of, or detracts from, the performance of the product. Nor does this warranty cover replacements or repairs necessitated by loss or damage resulting from any cause beyond the control of Gastite Division, including but not limited to, acts of God, acts of government, floods and fires.

The obligation of Gastite Division under this warranty is limited, at Gastite Division's discretion, to 1) making a replacement part available, 2) the repair of the defective part, or 3) refund of purchase price. This does not include the furnishing of any labor involved or connected therewith, such as that required to diagnose trouble or to remove or install any such product, nor does it include responsibility for any transportation expenses or any damages or losses incurred in transportation in connection therewith.

THE FOREGOING IS IN LIEU OF ANY OTHER WARRANTIES EXPRESSED, IMPLIED OR STATUTORY, INCLUDING, WITHOUT LIMITATION, THE IMPLIED WARRANTY OF MERCHANTABILITY, AND GASTITE DIVISION NEITHER ASSUMES NOR AUTHORIZES ANY PERSON TO ASSUME FOR GASTITE DIVISION ANY OTHER OBLIGATION OR LIABILITY IN CONNECTION WITH THE SALE OF ITS PRODUCTS

### INSTALLATION REQUIREMENTS

- 1) Installation must be performed strictly in accordance with local plumbing and/or building codes, and in accordance with Gastite®/FlashShield™ Design and Installation Guide.
- 2) Installation must be performed by an installer who has successfully completed a training program recognized by Gastite Division and has been issued a Certification Card.
- 3) Pressure testing must be performed during rough construction with piping system exposed.
- 4) Gastite Division assumes no responsibility for product or labor for any system which has been improperly installed.

# FREQUENTLY ASKED QUESTIONS

1. How do I correctly bond Gastite? ..... (page 73)
2. What training do I need to install Gastite®/FlashShield™? ..... (page 1 paragraph 2)
3. Can I tap into an existing black pipe system? ..... (page 5 bullet b)
4. Can I use Gastite®/FlashShield™ with natural gas / propane gas? ..... (page 5 bullet a)
5. Are Gastite®/FlashShield™ fittings approved for concealed use? ..... (page 56 section 4.3.4)
6. Can I use Gastite®/FlashShield™ outdoors? ..... (page 57 section 4.3.6)
7. Can Gastite®/FlashShield™ be run on a roof-top? ..... (page 63 bullet a)
8. If I cut the jacket too far back will it prevent sealing? ..... (page 5 bullet c)
9. What is the maximum pressure I can use with Gastite®/FlashShield™? ..... (page 103)
10. What's the maximum test pressure for Gastite®/FlashShield™? ..... (page 103)
11. Can Gastite®/FlashShield™ be run within a plenum? ..... (page 57 section 4.3.7)
12. What does EHD mean? ..... (page 99)
13. How tight a bend radius can I make? ..... (page 49 table 4-1)
14. Can I use pipe dope in the Gastite®/FlashShield™ fitting? ..... (bottom of page 50)
15. What size clearance holes do I drill? ..... (page 55 table 4-4)
16. How do I run Gastite through a firewall? ..... (page 57 section 4.3.7)
17. Can I use non-Gastite striker plates? ..... (page 58 section 4.4.1)
18. Can I connect Gastite®/FlashShield™ directly to the meter? ..... (page 60 section 4.5)
19. Can I connect Gastite®/FlashShield™ directly to an appliance? ..... (page 61 section 4.6)
20. Can I conceal a manifold? ..... (page 67 paragraph 2)
21. Can I bury Gastite®/FlashShield™? ..... (page 72 bullet a)
22. Is Gastite®/FlashShield™ allowed under a slab? ..... (page 72 bullet a)
23. Can I conceal a regulator? ..... (page 70 bullet a)
24. What is a vent limiter? ..... (page 70 bullet d)
25. Can I install a regulator outdoors? ..... (bottom page 70)
26. Can I install a regulator upside-down / sideways? ..... (page 70 bullet c)

# NOTES

# NOTES

# GASTITE®/FLASHSHIELD™ FLEXIBLE GAS PIPING TRAINING PROGRAM TEST

ADMINISTERED ONLY AFTER COMPLETION OF AUTHORIZED GASTITE®/FLASHSHIELD™ TRAINING COURSE.

Circle the appropriate answer.

- 1) Which requirement takes precedence for the installation of fuel gas piping systems?
  - a. The more restrictive requirement
  - b. Gastite® Design Guide
  - c. Local plumbing, mechanical or gas code

True    False
- 2) Gastite®/FlashShield™ CSST can be installed in combination with all approved fuel gas-piping materials such as black pipe and copper using approved threaded couplings at the interface.
 

True    False
- 3) Gastite®/FlashShield™ CSST is approved for direct burial in soil or concrete without sleeving.
 

True    False
- 4) The Jacket-Bite™ feature is required when making FlashShield™ fitting connections?
 

True    False
- 5) In addition to Gastite®/FlashShield™ fittings, fittings from other CSST manufacturers' can be used on the Gastite®/FlashShield™ CSST.
 

True    False
- 6) Gastite® XR2 fittings can be used on FlashShield™ tubing?
 

True    False
- 7) Strike protection is required whenever the tubing is: concealed and constrained and within 3 inches of a potential threat.
 

True    False
- 8) For most installations, tubing connected to a termination fitting assembly should be protected by strip wound steel conduit for the first 6 inches from the connection.
 

True    False
- 9) For elevated pressure systems, it is necessary to isolate or remove the line pressure regulator during pressure tests.
 

True    False
- 10) Other continuous metallic systems may be used as a means of support for Gastite® CSST.
 

True    False
- 11) Gastite®/FlashShield™ CSST can be used for either natural gas or propane systems.
 

True    False
- 12) Electrical bonding of Gastite® CSST must be performed by \_\_\_\_\_.
  - a. A qualified electrician
  - b. A certified Gastite installer
  - c. A utility.
  - d. Any of the above depending on local jurisdiction approval.
- 13) Gastite®/FlashShield™ CSST must be terminated to a fixed point for \_\_\_\_\_.
  - a. Moveable appliance connections
  - b. High pressure systems
  - c. Pressure testing the gas piping system
- 14) The line pressure regulator is only required for elevated pressures exceeding 1/2 psi (14 inches water column).
 

True    False
- 15) Installation clearance holes for routing flexible gas piping are to be at least \_\_\_\_\_.
  - a. 2 inches in diameter
  - b. 1/2 inch larger than the tubing O.D.
  - c. As large as building code permits
- 16) In the absence of local requirements, the system should be pressure tested in accordance with the most current edition of NFPA 54.
 

True    False

17) When using the "Longest Run" method for sizing a Gastite®/FlashShield™ CSST system, the tubing length considered is \_\_\_\_.

- a. The maximum distance from the meter to the furthest appliance location
- b. The actual length of each individual run only
- c. Not really a factor because 1/2" piping has always done the job

18) Only listed Gastite®/FlashShield™ Striker Plates are to be used to protect Gastite®/FlashShield™ CSST when passing through structural members.

True False

19) Unlike Gastite®, FlashShield™ CSST can be installed within a chase that contains a metallic chimney liner.

True False

20) Pressure testing of the installed Gastite®/FlashShield™ system in new construction must be performed during rough construction of the facility before interior walls are finished.

True False

PLEASE PRINT CLEARLY OR YOU WILL NOT RECEIVE YOUR PERMANENT CERTIFICATE

Date: \_\_\_\_\_

Name: \_\_\_\_\_

Signature: \_\_\_\_\_

Title: \_\_\_\_\_

Company: \_\_\_\_\_

Address: \_\_\_\_\_

City: \_\_\_\_\_

State: \_\_\_\_\_ Zip Code: \_\_\_\_\_

E-Mail: \_\_\_\_\_

Personal data will not be shared outside of Gastite® and will be used to update you on product updates and changes.

Instructor: \_\_\_\_\_

Signature: \_\_\_\_\_

Certificate # 10GF015001

 		<p>The following person has successfully completed the Gastite Certification Training Program and is hereby recognized as a</p> <p style="text-align: center;"><b>Qualified Installer</b></p>	
_____	_____	_____	_____
Name		Instructor	
_____	_____	_____	_____
Company		Issue Date	
		<i>Valid for 90 Days from Date of Issue</i>	
_____			
Certificate No.			
<p>Authorized to purchase and install Gastite® &amp; FlashShield™ Flexible Gas Piping</p>		<p>1-800-662-0208 / www.Gastite.com 10GF015001</p>	







**Gastite**<sup>®</sup>  
The System is the Solution<sup>™</sup>

Gastite Division  
1116 Vaughn Parkway  
Portland, TN 37148  
Toll Free: 800.662.0208  
Fax: 615.325.9407  
Web: [www.gastite.com](http://www.gastite.com)  
E-mail: [gastite@gastite.com](mailto:gastite@gastite.com)