

 1,368 Lumens
 2,478K CCT
 99 CRI

NOTES: THE LIGHT ON THE BECKWITH™ IS CONSIDERED AN ACCENT LIGHT AND IS NOT INTENDED TO BE USED AS A PRIMARY LIGHT SOURCE. NOT RECOMMENDED FOR SOUND SENSITIVE AREAS

*With included 4.5" downrod—longer lengths available
 Close-to-ceiling kit compatible
 Net Hanging Weight: 27.16 lbs.

 **FAN: FP7964BN** (1)
 brushed nickel assembly
 with frosted white shade



 **FAN: FP7964OB** (1)
 oil-rubbed bronze assembly
 with frosted white shade





For compatible controls & accessories see pages 183 - 193

Recommended optional control

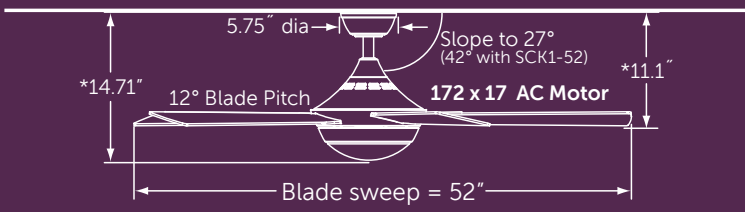

C25



 1,350 Lumens
 3,000K CCT
 80 CRI

*With included 4.5" downrod—longer lengths available Net Hanging Weight: 18.74 lbs.



 **FAN: FP8062BN** (1)
 brushed nickel assembly with
 frosted white glass and reversible
 cherry/dark walnut blades

- cherry side showing



 **FAN: FP8062DZ** (1)
 dark bronze assembly with
 frosted glass and reversible
 cherry/dark walnut blades

- dark walnut side showing



 **FAN: FP8062MW** (1)
 matte white assembly
 with frosted glass and
 matte white blades





For compatible controls & accessories see pages 183 - 192

Recommended optional control

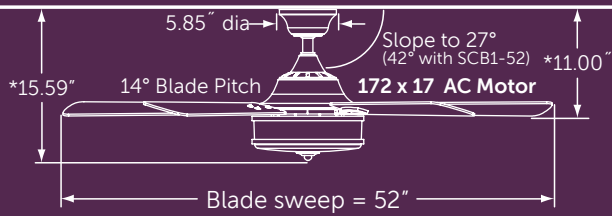

C25





 1,020 Lumens
 2,700K CCT
 99 CRI

*With included 4.5" downrod—longer lengths available
 Close-to-ceiling kit compatible

Net Hanging Weight: 23.2 lbs.

- 
FAN: PL8274BN (1)
 brushed nickel assembly with
 frosted white glass and reversible
 cherry/dark walnut blades
 - dark walnut side showing



- 
FAN: PL8274DZ (1)
 dark bronze assembly with
 frosted white glass and reversible
 cherry/dark walnut blades
 - cherry side showing



- 
FAN: PL8274BN (1)
 brushed nickel assembly with
 frosted white glass and reversible
 cherry/dark walnut blades
 - cherry side showing



- 
FAN: PL8274DZ (1)
 dark bronze assembly with
 frosted white glass and reversible
 cherry/dark walnut blades
 - dark walnut side showing

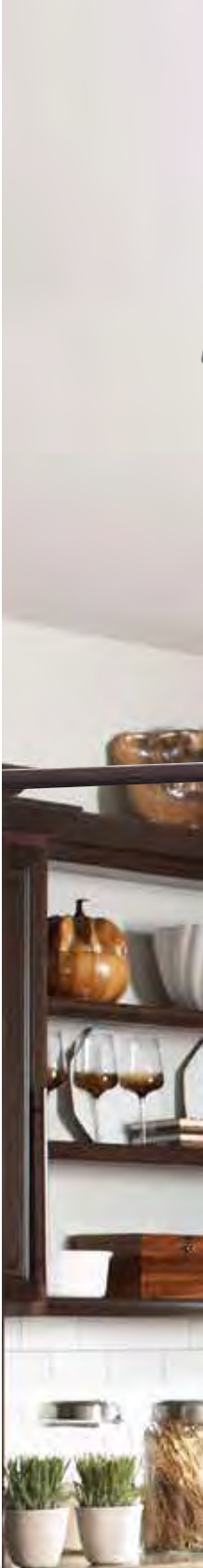

For compatible controls & accessories see pages 183 - 193

Recommended optional controls





C25

or

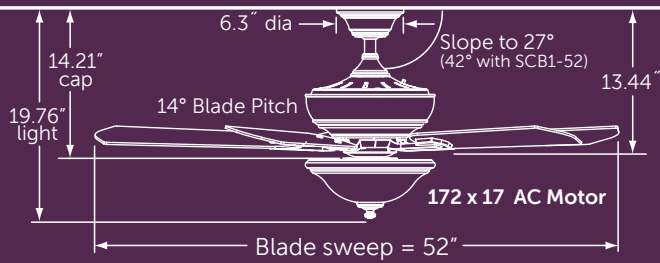

CW60WH





 2,062 Lumens
 2,756K CCT
 99 CRI

*With included 4.5" downrod—longer lengths available
 Close-to-ceiling kit compatible
 Net Hanging Weight: 24.47 lbs.

FAN: FP8095BA (1)
 bronze accent assembly with
 frosted white glass and reversible
 cherry/walnut wood blades
 ● walnut side showing





FAN: FP8095OB (1)
 oil-rubbed bronze assembly (shown
 without light kit) with reversible
 cherry/walnut wood blades
 ● cherry side showing



FAN: FP8095PW (1)
 pewter assembly with frosted
 white glass and reversible
 cherry/walnut wood blades
 ● walnut side showing



FAN: FP8095WH (1)
 white assembly with white frosted
 glass and white wood blades



For compatible controls &
 accessories see pages 183 - 193

Recommended optional controls





C25

or

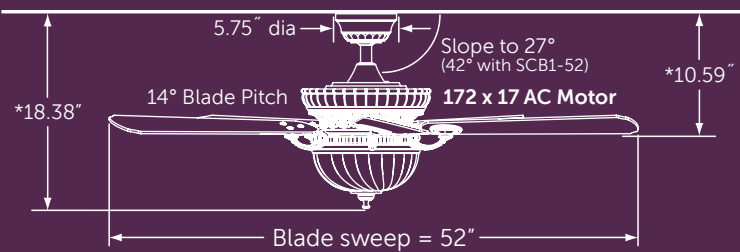

CW60WH



 1,092 Lumens
 2,653K CCT
 99 CRI

*With included 4.5" downrod—longer lengths available
 Close-to-ceiling kit compatible
 Net Hanging Weight: 24.5 lbs.



FAN: FP8032DZ (1)
 dark bronze assembly
 with frosted white glass
 and reversible cherry/dark
 walnut blades
 ● cherry side showing



FAN: FP8032DZ (1)
 dark bronze assembly
 with frosted white glass
 and reversible cherry/dark
 walnut blades
 ● dark walnut side showing

For compatible controls &
 accessories see pages 183 - 193

Recommended optional controls



C25

or



CW60WH



For dimensions and configurations, please see our model-specific specification sheet, available at fanimation.com

Not recommended for use in sound sensitive areas.

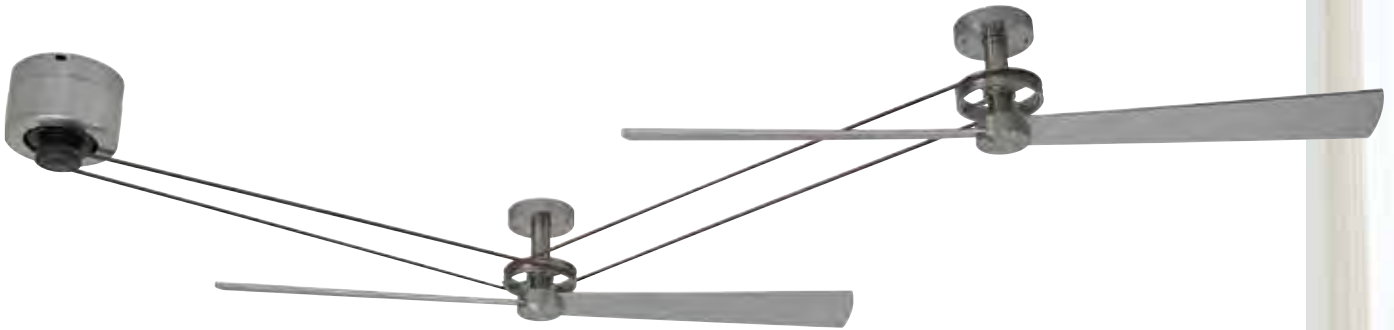

- ◆ **MOTOR: MA7966BN** (1)
brushed nickel
- HEAD: HA7966BN** (2)
brushed nickel assembly
- BLADE SET: B7966BN** (2)
56" sweep brushed nickel

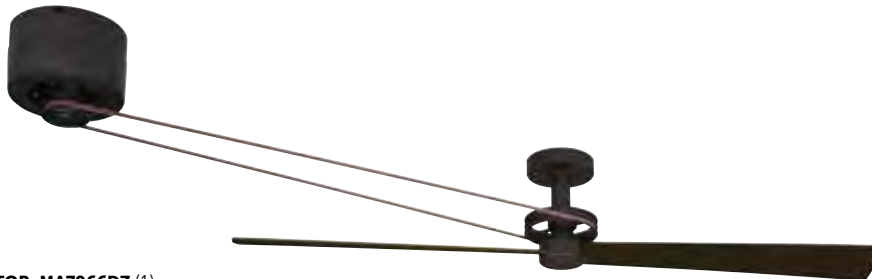

- ◆ **MOTOR: MA7966DZ** (1)
dark bronze
- HEAD: HA7966DZ** (1)
dark bronze assembly
- BLADE SET: B7966CYDWA** (1)
56" sweep reversible
cherry/dark walnut
- dark walnut side showing

For compatible controls & accessories see pages 183 - 192

Recommended optional control



C25





BN—brushed nickel

CYDWA—cherry/dark walnut reversible

B7966**
56" wood

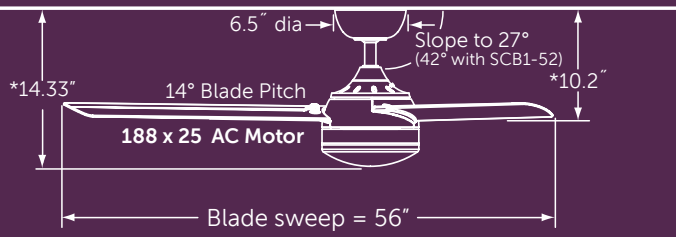





 1,350 Lumens
 3,000K CCT
 80 CRI

*With included 4.5" downrod—longer lengths available
 True stainless steel rust resistant downrods available
 Net Hanging Weight: 16.32 lbs.



FAN: FP6728BN (1)
 brushed nickel assembly with
 opal frosted glass and brushed
 nickel blades



FAN: FP6728DZ (1)
 dark bronze assembly with opal
 frosted glass and dark walnut
 blades

For compatible controls & accessories see pages 183 - 193

Recommended optional controls





C25

or

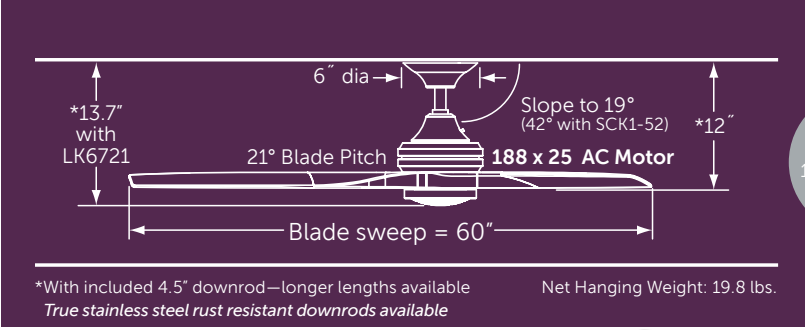

CW60WH





 1,350 Lumens
 3,000K CCT
 80 CRI

*With included 4.5" downrod—longer lengths available
 True stainless steel rust resistant downrods available
 Net Hanging Weight: 19.8 lbs.





FAN: MA6721BN (1)
 brushed nickel assembly
BLADES: B6720BN (1)
 brushed nickel finish buttonwood





FAN: MA6721BL (1)
 black assembly
BLADES: B6720BL (1)
 black finish buttonwood





FAN: MA6721BS (1)
 brushed satin brass assembly
BLADES: B6720WK (1)
 whiskey wood finish buttonwood





FAN: MA6721DF (1)
 driftwood assembly
BLADES: B6720DF (1)
 driftwood finish buttonwood





FAN: MA6721GR (1)
 matte greige assembly
BLADES: B6720WE (1)
 weathered wood finish buttonwood



FAN: MA6721GZ (1)
 galvanized assembly
BLADES: B6720WK (1)
 whiskey wood finish buttonwood





FAN: MA6721MW (1)
 matte white assembly
BLADES: B6720WW (1)
 white washed finish buttonwood
LIGHT KIT: LK6721MW (1)
 matte white
 (shown with frosted pc lens—included)



For compatible controls & accessories see pages 183 - 193



B6720**
 60" button wood 

- BL—black
- BN—brushed nickel
- DF—driftwood
- DWA—dark walnut
- N—natural
- WE—weathered wood
- WK—whiskey wood
- WW—white washed

includes
 frosted and
 fresnel lenses



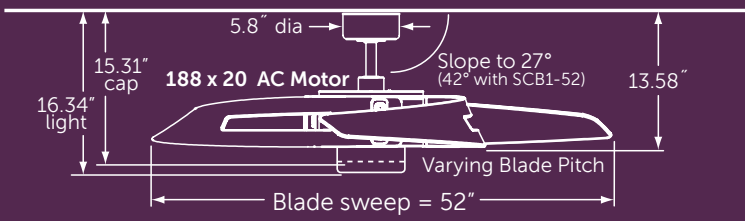

LK6721**
 18W LED 

 1,350 Lumens
 3,000K CCT
 80 CRI





 1,176 Lumens
 2,800K CCT
 99 CRI

*With included 6" downrod—longer lengths available Net Hanging Weight: 28.4 lbs.
 Close-to-ceiling kit compatible; *True stainless steel rust resistant downrods available*

FAN: FP6210SN (1)
 satin nickel assembly
 with walnut blades
 and opal frosted glass



FAN: FP6210OB (1)
 oil-rubbed bronze assembly
 with cherry blades and opal
 frosted glass



FAN: FP6210SN (1)
 satin nickel assembly with
 walnut blades and matching
 light cover (included)



For compatible controls &
 accessories see pages 183 - 193

Recommended optional control



C25

my FANIMATION DISTINCTION™

3. Fitters

- Lumens: 1,650
- Color Temp: 2,700
- CRI: 99



F1		
BN	DZ	MW

- Lumens: 1,600
- Color Temp: 2,700
- CRI: 80



F2		
BN	DZ	MW

- Lumens: 1,350
- Color Temp: 3,000
- CRI: 80



F3		
BN	DZ	MW

- Lumens: 1,400
- Color Temp: 2,700
- CRI: 99



F4*		
BN	DZ	MW

4. Glass

	G1	G2	G3	G1	G4	G5	G6
CL			☒		☒		☒
MS	☒			☒			
OP		☒	☒			☒	☒
OPS			☒		☒		
TST	☒	☒		☒	☒	☒	☒

*Additional glass available on page 154

5. Controls



For use with A1 and C1 motors		For use with D1 motor	
BTT9R —included	C21 —sold separately	TR205 —included	TW206 —sold separately
White hand-held remote control with wall mount	White wall control with wall plate	White hand-held remote control with wall mount	White wall control with wall plate

WALL CONTROLS

- Wall controls include matching face plate
- Control options are not available for Bourbon Street®, Palmetto® and Punkah®

• UL LISTED

-  Included
-  Optional

Do not store or mount wall controls outdoors unless using WP60 waterproof box

WH—White LA—Light Almond



C21

- Reversible fan and light control
- 2-wire installation
- 3 fan speeds
- infinite light levels
- Control only. Does not include receiver.
- Four use with 4-dipswitch and fansync receivers

C25



















































- Non-reversing fan and light control
- battery operated
- 3 fan speeds
- infinite light levels
- Control only. Does not include receiver.
- Four use with 4-dipswitch and fansync receivers

CW1WH & CW1LA

- Fan-only slide control
- 2-wire installation
- 3 fan speeds
- 1.25 amps max. fan load

CW1SWWH & CW1SWLA

- Fan slide control with
- light on/off toggle switch
- 3-wire installation
- 3 fan speeds
- 1.25 amps max. fan load

Aire Décor®—All				
Aire Deluxe™—All				
Ascension™				
Avaston™				
Beckwith™				
Belleria®				
Benito™ v2				
Big Island™				
Brewmaster®				
Camhaven™				
Cancun™—All				
Caruso™				
Celano v2™				
Crestford™				
Drone™				
Duplex™				
Edgewood®—All				
Embrace™—All				
Enigma®				
Extraordinaire®				
Hugh™—All				
Islander® AC				
Islander® DC				
Kaya™				
Kellan™				
Levon™ AC				
Levon™ Custom—All				
myFanimation™ Distinction™ AC				
myFanimation™ Distinction™ DC				
Odyn™—All				
Old Havana®				
Palisade®				
Palma™				
Pickett™				
Pickett™ Drum				
Rotation™				
Spitfire™				
Stafford™				
Stellar™—All				
Subtle™				
Torch™				
Torto™				
Torto™ LED				
Ventana™				
Windpointe®—All				
Xeno™ Damp				
Xeno™ Wet				
Zonix™ Wet				
Zonix™ Wet Custom			