

DIGITAL MULTIMETER

Model: LT17A

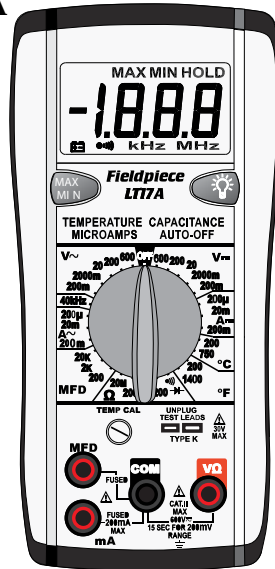

OPERATOR'S MANUAL

General Specifications

Auto-off: off after 25 minutes to extend battery.
Indicators: Continuity beeper (<100Ω). Low bat.
Overrange: "OL" or "-OL" is displayed.
Operating environment: 32 to 122°F (0 to 50°C) <70%RH
Storage environment (with batteries removed): -4 to 140°F (-20 to 60°C) <80%RH
Altitude: 6561.7 feet (2000m).
Battery life: 150 hours typical.
Battery type: 9V NEDA 1604 type
Stated accuracies: 74°F±8°F (23°C±4°C), 75%RH
Temperature coefficient: 0.1 x (specified accuracy) 1°F/°C (32 to 66°F (0 to 19°C), 82 to 122°F (28 to 50°C)).

DC Voltage

Ranges: 200mV, 2000mV, 20V, 200V, 600V
Resolution: 0.1mV
Accuracy: 0.5%±1

Input impedance: 10MΩ

AC Voltage (50Hz-500Hz)

Ranges: 200mV, 2000mV, 20V, 200V, 600V
Resolution: 0.1mV
Accuracy: 1.2%±4(200mV to 20V ranges), 2%±4(200V and 600V ranges)

Input impedance: 10MΩ

DC Current (through meter)

Ranges: 200μA, 20mA, 200mA
Resolution: 0.1μA

General description

The LT17A is designed for the HVAC/R technician. The LT17A meter measures current, resistance, voltage, capacitance, frequency, continuity, and temperature. Test leads store within the meter and can connect the LT17A to Fieldpiece accessory heads. The body is made out of durable ABS plastic and comes with a bright blue backlight for poorly lit test areas. Get great accuracy with the k-type thermocouple and easily accessible temp. pot.

User maintenance

Battery Replacement: When the multimeter displays the " " the battery must be replaced to maintain proper operation. To prevent electrical shock, turn off the meter and disconnect leads before removing the back cover.

Fuse Replacement: When only certain ranges quit working, check the fuse. Open the case and replace according to the Overload Protection chart.

All other repairs must be performed by a Fieldpiece service center.

Accuracy: 1.0%±1
Voltage burden: 800mV
AC Current (through meter)
Ranges: 200μA, 20mA, 200mA
Resolution: 0.1μA
Accuracy: 1.5%±4
Voltage burden: 800mV
Frequency (autoranging)
Range: 10Hz to 40KHz
Resolution: 1Hz
Sensitivity: 3.5V rms min
Accuracy: 0.1%± 3
Resistance (ohms)
Ranges: 200Ω, 2kΩ, 200kΩ, 20MΩ
Resolution: 0.1Ω

Accuracy: 1.0%±4 (200Ω to 200kΩ ranges), 2.0%±4 (20MΩ range)

Open circuit voltage: 0.3VDC typical, (3.0VDC on 200Ω)

Diode Test

Accuracy: 1.5%±3
Test current: 1.0mA approx.
Open circuit voltage: 3.0VDC typical

Capacitance (MFD)

Ranges: 200μF, 2kμF, 20kμF
Resolution: 0.1μF
Accuracy: 4%±10
Test frequency: 21Hz
Test voltage: <3.0V

For your safety...

General: Inspect the test leads for damage to the insulation or exposed metal. Replace if suspect. Never ground yourself when taking electrical measurements. Do not touch exposed metal pipes, outlets, fixtures, etc., which might be at ground potential. Keep your body isolated from ground by using dry clothing, rubber shoes, rubber mats, or any approved insulating material. When disconnecting from a circuit, disconnect the "RED" lead first, then the common lead. Work with others. Use one hand for testing. Turn off power to the circuit under test before cutting, unsoldering, or breaking the circuit. Keep your fingers on the plastic and behind the ridge of the probes.

All Voltage Tests: All voltage ranges will withstand up to 600VAC or 600VDC. Do not apply more than 600VDC or 600VAC.

AC Tests: Disconnect the meter from the circuit before turning any inductor off, including motors, transformers, and solenoids. Hi voltage transients can damage the meter beyond repair. Do not use during electrical storms.

Safety: Designed to meet IEC 61010-1 (EN61010-1), CATIII 600V, Class II, pollution deg.2, indoor use and complies with CE. C-Tick certified.

Symbols used:

- ⚠ Caution, refer to manual.
- ⏚ Ground
- ⏚ Double insulation

Temperature

Ranges: -30 to 1400°F (-34 to 750°C)
Resolution: 0.1°F/°C
Accuracy: ±1°F; 32 to 120°F (±0.5°C; 0 to 48°C), ±1.0%±1.5°F; -4 to 750°F (±1.0%±1.0°C; -20 to 399°C)
±3.0%±4°F; -30 to -4°F and 750 to 1400°F (±3.0%±2°C; -34 to -20°C and 399 to 750°C)
Sensor type: K-type thermocouple

Field Calibration (temp offset pot)

The LT17A can be easily calibrated on the job. Use a bucket of ice water to have a known 32°F (0°C) temperature. With the thermocouple in the ice water, adjust the TEMP OFFSET pot on the face of the meter until it reads 32.0 (0.0).

MAX/MIN

Record the minimum or maximum reading during a measurement. To exit the MIN/MAX function, hold the button for more than 2 seconds.

Backlight

Always be very careful when testing in the dark. You should always have a separate light on the area you are testing. The backlight will shine for 4.5 minutes when the backlight button is pressed.

Overload protection

VAC/DC	200mV range	600VAC/DC rms for 15 sec
	>200mV range	600VAC/DC rms
AAC/DC		0.25A/500V fuse (6.3X32mm) model RFM66
Capacitance		0.25A/500V fuse (6.3X32mm) model RFM66
Temperature		30VAC/DC rms
Frequency		500VAC/DC rms
Resistance		500VAC/DC rms
Diode Test		500VAC/DC rms
Continuity		500VAC/DC rms

Service

Call Fieldpiece Instruments for one-price-fix-all warranty service pricing. Send check or money order for the amount quoted. Send the meter freight prepaid to Fieldpiece Instruments. Send proof of date and location of purchase for in-warranty service. The meter will be repaired or replaced, at the option of Fieldpiece, and returned via least cost transportation.

www.fieldpiece.com

Limited warranty

This meter is warranted against defects in material or workmanship for one years from date of purchase. Fieldpiece will replace or repair the defective unit, at its option, subject to verification of the defect.

This warranty does not apply to defects resulting from abuse, neglect, accident, unauthorized repair, alteration, or unreasonable use of the instrument.

Any implied warranties arising from the sale of a Fieldpiece product, including but not limited to implied warranties of merchantability and fitness for a particular purpose, are limited to the above. Fieldpiece shall not be liable for loss of use of the instrument or other incidental or consequential damages, expenses, or economic loss, or for any claim of such damage, expenses, or economic loss.

State laws vary. The above limitations or exclusions may not apply to you.

Fieldpiece
Designed in USA
MADE IN TAIWAN

How To Use Your Multimeter

For DC voltage and currents, set the meter to the DC parameter instead of AC as shown to the left. For all ranges and functions choose range just above value you expect. If display reads "OL" or "-OL" (overload), select a higher range. If display shows less than three numbers, select a lower range for better resolution.

Voltage

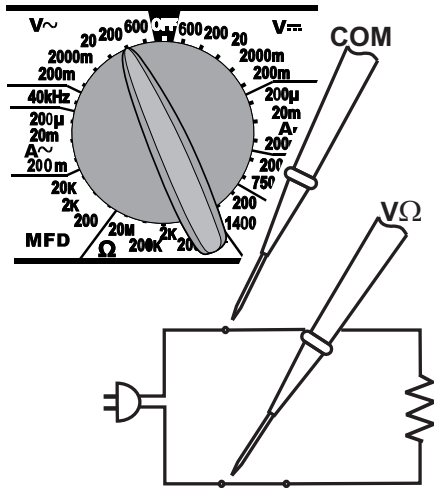

Amps

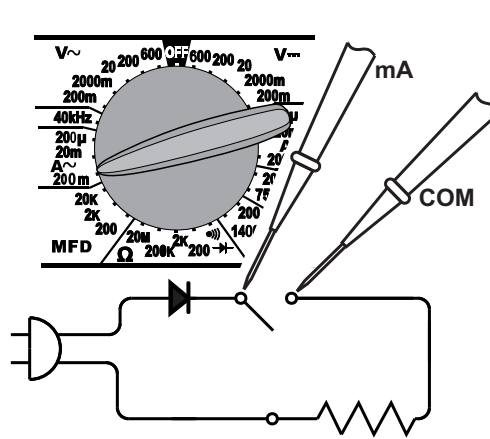

Microamps

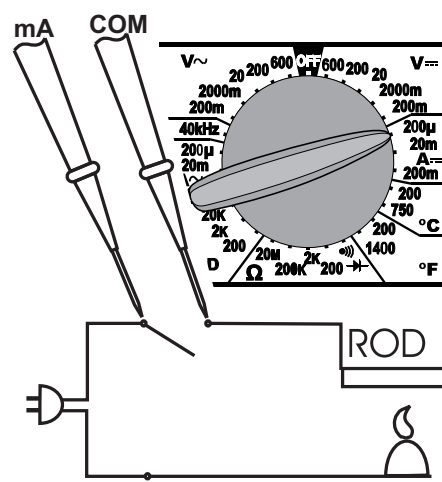

Resistance & Continuity Beeper

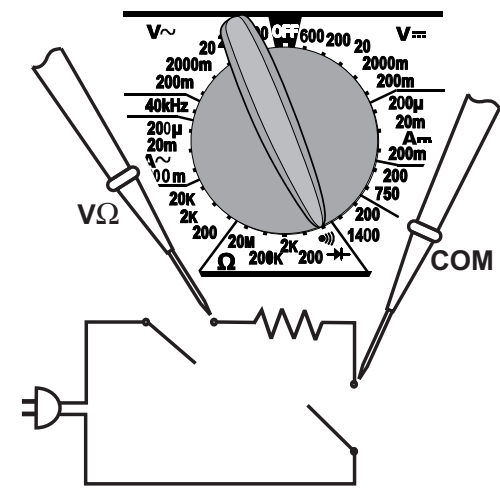

Frequency

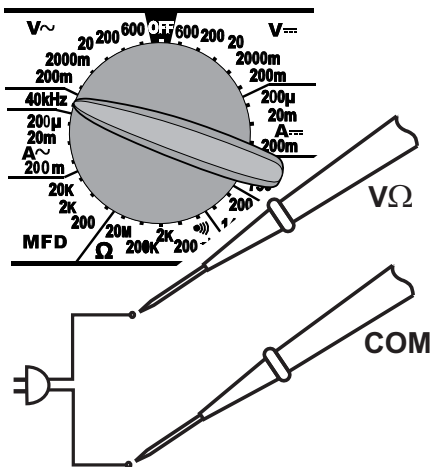

AC current clamp

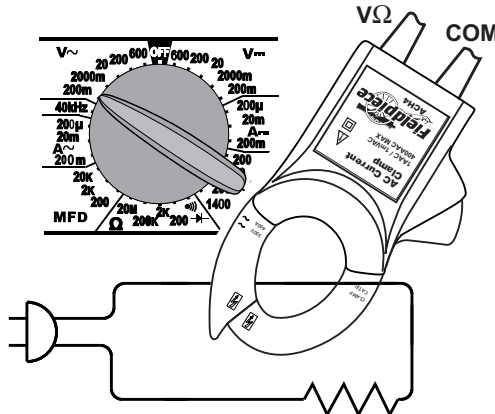

Capacitance (MFD)

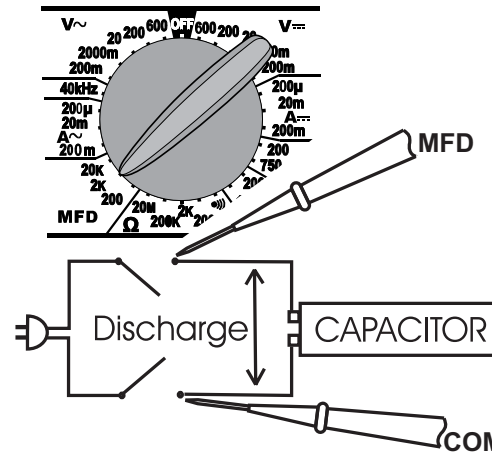

Optional accessory heads

Fieldpiece accessory heads convert the desired parameter into a millivolt signal. For example, the ARH4 converts one °F/°C into one milli-volt DC. The multimeter must then be set to read millivolts DC. One exception is the ACH4 current clamp which must be set to read AC millivolts. Any digital multimeter with these scales can be used in conjunction with Fieldpiece Accessory Heads.

Use Fieldpiece deluxe silicone test leads (model# ADLS2) with removable probe tips to use the accessory heads with the LT17A.

