

Dual Port Differential Manometer Accessory Head Model: ADMN2

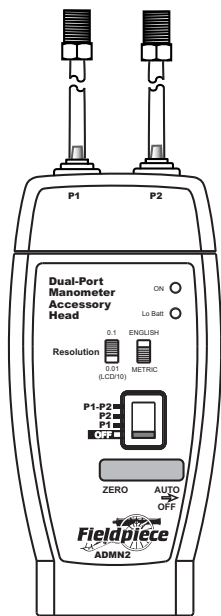

OPERATOR'S MANUAL

Description

The ADMN2 is a portable dual port manometer accessory head. The ADMN2 is capable of taking gas pressure as well as static pressure. The ADMN2 also has a zero adjust. The auto-power-off function conserves battery life, but can be disabled for data logging if desired.

The ADMN2 will allow you to take gas pressure between -60inWC and 60inWC. The ADMN2 can measure P1 or P2 pressure readings or the difference between P1 and P2. The ADMN2 also has two different measurement scales: inWC (inches of water column) and mBar. Static pressure is possible with the resolution of 0.01inWC or 0.01mBar.

Operation

1. Connect to COM and Volts jacks using any Fieldpiece test leads with removable probe tips. For Fieldpiece "stick-style" meters, EHDL1, or DL3, slide the head directly over the meter.
2. Select the mVDC range.
3. Zero the ADMN2 by pressing the ZERO button just before taking the pressure readings, while at ambient pressure. This will zero both P1 and P2.
4. Connect a single hose to get the gauge pressure relative to the ambient or ZERO pressure.
5. Connect both hoses if you want to see relative pressure, P1 minus P2.

6. Select P1, P2, or P1 - P2.
7. Select English (inches of water column) or Metric (mBar) units.
8. To disable the auto-power-off, remove the rubber covering and flip the switch below. Auto-power-off is helpful for conserving the battery; but if you are data logging with Fieldpiece model DL3, you will want to disable this feature.
9. If you are in an environment where the temperature is noticeably changing while you are taking your reading, disconnect the meter from the hoses and ZERO it relative to ambient pressure before each reading.

Checking Gas Pressure on a Regulator

1. Screw the brass fitting into the pressure port on the regulator.
2. Put unit into operation (i.e. turn on the furnace and have furnace ignite, as if running it in normal operation.)
3. This will give you the pressure coming out of the regulator.
4. If you suspect high or low inlet pressure into the regulator, the manometer can hook into the inlet port in the same manner it can connect into the outlet port. If you have a dual-port manometer, you can check both the inlet and the outlet simultaneously and see the pressure drop across the regulator.
5. See manufacturer's specification for the specifi-

cations on target inlet and outlet pressure for a given regulator or piece of combustion equipment.

Field Pressure Calibration

Remove the rubber covering the ZERO button. By pressing the ZERO button, both the P1 and P2 are zeroed to the ambient pressure. For this reason the calibration should be done when both P1 and P2 are disconnected from the hoses in order to properly calibrate to ambient pressure.

Connect Your Way

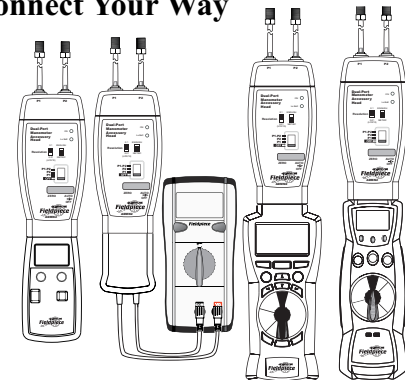

EHDL1 LT series DL3 HS series

Specifications

Pressure Ports: Two tube connectors for 4mm (3/16 inch) I.D. flexible tubing

Units of Measure: inWC and mbar

Accuracy:

- ±0.02inWC, ±(0.00inWC to 2.00inWC);
- ±1.5% FS, ±(2.00inWC to 60.0inWC);
- ±0.05mbar, ±(0.00mbar to 5.00mbar);
- ±1.5% FS, ±(5.00mbar to 150.0mbar);

Resolution: 0.1 or 0.01 depending on resolution selected (If 0.01 resolution is selected you must divide displayed value by 10 for actual value).

Measurement Range:

- inWC: -60.0 to 60.0
- mBar: -150.0 to 150.0

Operating environment:

32°F (0°C) to 122°F (50°C), under 75%RH

Compatible media: Dry, non-corrosive gases

Battery: Single standard 9-volt battery, NEDA 1604, JIS 006P, IEC 6F22.

Battery Life: 100 hours with low battery LED indicator on accessory head.

Overrange: "OL" or "-OL" is displayed.

Auto power off: 15 minutes

Dimensions: 131mm(~5 3/16")(H) x 67mm(~2 7/16")(W) x 32mm(~1 1/4")(D)

Weight: approximately 154g (~1/2 pound) including battery

Resolution Modes (0.1 and 0.01)

There are two modes of resolution on the ADMN2. For most applications, 0.1 mode will be fine to use. When measuring low pressures, 0.01 will likely be the best mode for meaningful testing. The most common circumstance for 0.01 mode is measuring static pressure across a blower.

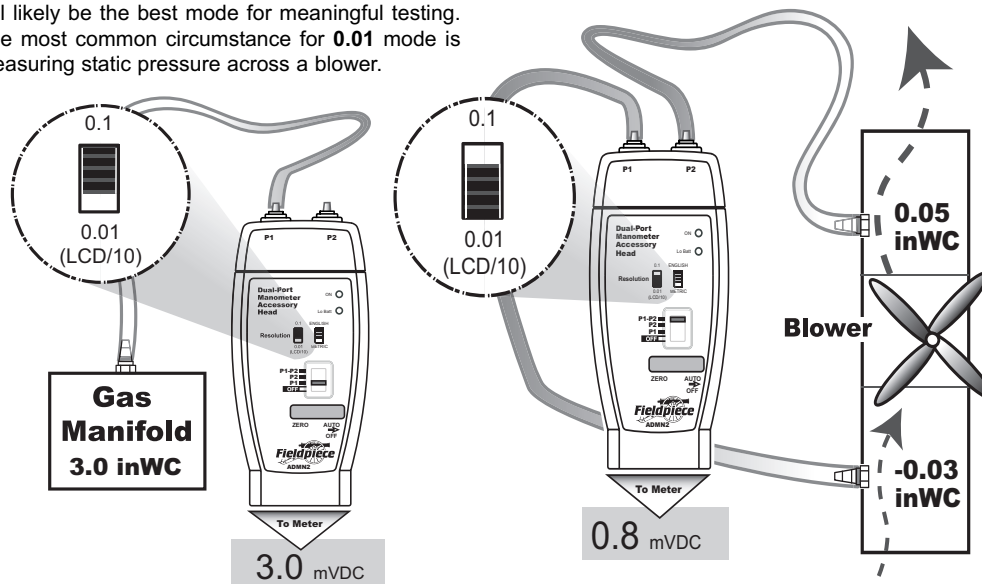

Gas pressure measurement
(0.1 resolution mode)

Static pressure across a blower
(0.01 resolution mode)
0.8mVDC / 10 = 0.08inWC

Warranty

The product is warranted to the original purchaser against defects in material or workmanship for a period of one (1) year from the date of purchase. During the warranty period, Fieldpiece Instruments will, at its option, replace or repair the defective unit.

This warranty does not apply to defects resulting from abuse, neglect, accident, unauthorized repair, alteration, or unreasonable use of the instrument. Any implied warranty arising out of the sale of Fieldpiece's products including but not limited to implied warranties of merchantability and fitness for purpose are limited to the above. Fieldpiece shall not be liable for incidental or consequential damages.

Service

Return any defective ADMN2 to Fieldpiece for warranty service along with proof of purchase. Contact Fieldpiece for out of warranty repair charges.

Fieldpiece
Designed in USA
MADE IN THAI

RMA316 Manometer Adapter

Used for 5/16" pressure outlet ports.

1. Shut off main gas supply to furnace.
2. Move the gas valve switch to "OFF" position.
3. Use a 3/32" hex wrench to loosen the outlet pressure tap screw. Rotate screw counter-clockwise one revolution to open.
4. Connect the ADMN2 tubing to the smaller (3/16") end of the adapter and the other (5/16") end of the adapter into the of the adapter tube.
5. Slide the 5/16" adapter tube over the outlet pressure boss (port) to seal. Overlap the pressure boss by at least 3/8" to prevent leakage.

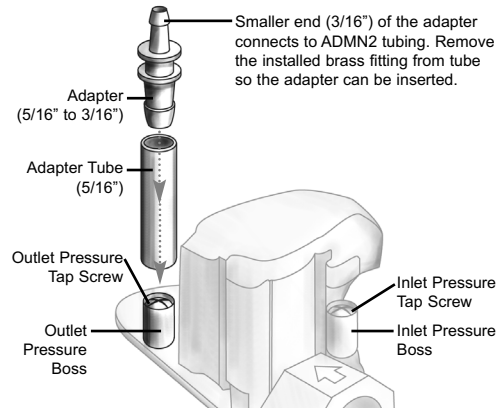

More Products From Fieldpiece

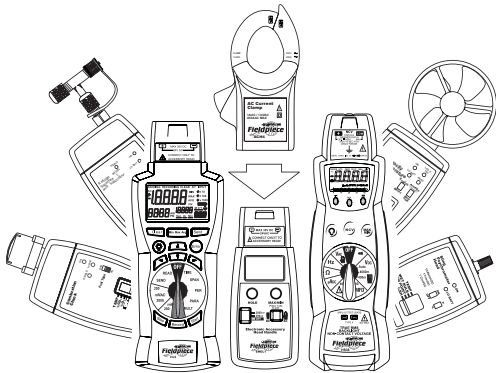

Modular Expandability

Modular expandability is ability for accessory heads and meters to change configurations to match the various needs of an HVAC/R technician.

Accessory heads (the sensors) send out a mV signal, which represents the value of the measurement, to whatever meter is attached to it. Heads can attach directly to the top of a Stick meter, DL3 data logger, or EHD1. They can also plug into any meter with mV ranges using ASLS2 leads.

Stick Meter

This is the heart of modular expandability. In addition to being a full functioning multimeter, any accessory head can be used with it.

Model HS36

Non contact voltage
Magnetic hanger
Autorangeing
Backlight

Temperature
Volts, amps, ohms
Frequency
Microfarads

Includes:
HS36 Meter
ACH4 Current Clamp
ATB1 K-type TCouple
ADLS2 Deluxe Leads
ANC1 Case

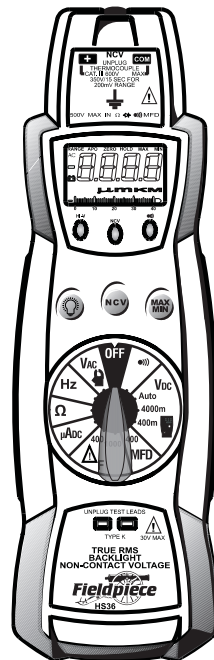

Accessory Heads

Accessory heads are the sensors of multiple parameters measured by technicians every day. They plug into a mV range (depending on the head) of a multimeter. The multimeter will display whatever the head is measuring. Instead of having to purchase and carry a separate instrument for each parameter, a technician can use multiple heads and a single multimeter to do the job.

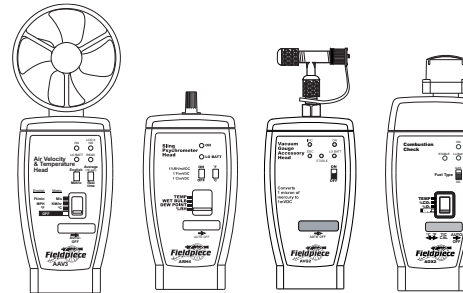

Here are four of the many heads available:

- AAV3 Air Velocity and Temperature
- ARH4 Digital Psychrometer
- AVG2 Digital Vacuum Gauge
- AOX2 Combustion Check

ASP2 Static Pressure Probe

For accurate static pressure measurements.

1. Connect ASP2 to ADMN2 via hose.
2. Insert ASP2 into drilled or pre-existing 1/4" hole.
3. Use alignment arrow on the ASP2 to direct probe into the air stream.
4. Read static pressure measurements from "stick-meter", EHD1 or record with DL3.
5. Remove probe and patch hole.

