

## Features

- CADDY® Fasteners from ERICO® provide the solutions you need to install a variety of lighting fixtures in a wide range of applications and environments.
- Utilizing innovative designs, CADDY Fasteners are easy to install and contribute to low total installed costs.
- CADDY products are UL® Listed, where applicable, and are designed to help enable code-conforming installations.



Choose from a variety of CADDY® solutions for your lighting applications, including:

**Bay Lighting Support:** The CADDY® SPEED LINK Universal Support System provides for a wide range of retail, industrial and commercial applications.



**Acoustical T-Grid Support:** CADDY support clips are ideal for various lighting applications, such as lay-in, track and linear fluorescent.

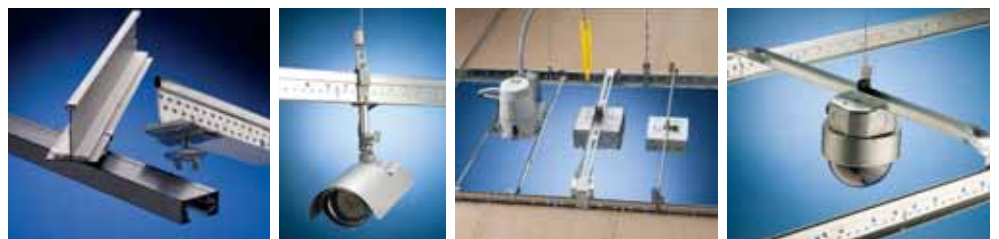

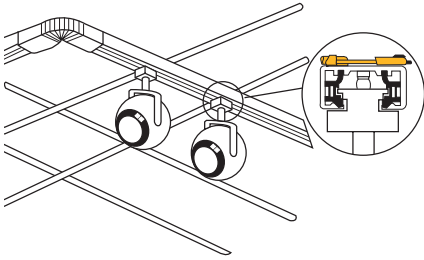

2G9 Twist-on Track Light Clips

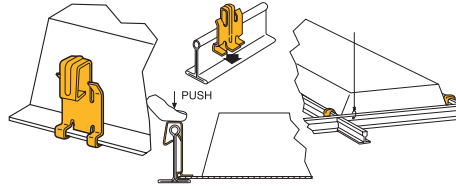

515A Lay In and Troffer Light Fixture Support Clip

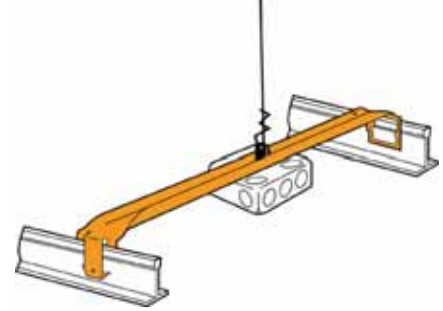

512HD Box Hanger

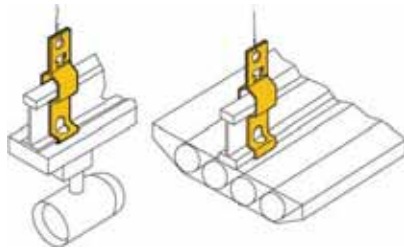

IDS Independent Support Clip

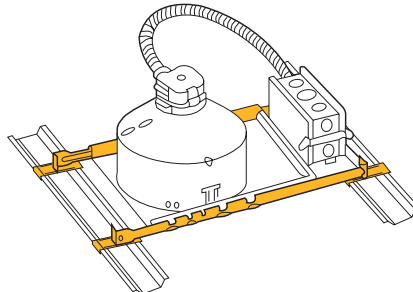

517 Series Light Fixture Suspension Bars

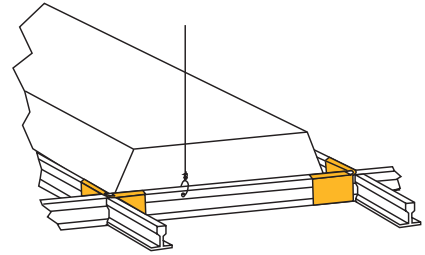

SFCLT Seismic Fixture Clamp

## Choose from a variety of CADDY lighting products:

<b>Bay Light Supports</b>	
CADDY® SPEED LINK and CADDY® SPEED LINK LD Main structure attachments for CADDY SPEED LINK Fluorescent light fixture V-hangers	SL, SL LD 4H24, VF14, AF14, ESC LFC, LFC90
<b>Lay-in and Troffer Light Supports</b>	
Attachment clips for straight and upturned lip fixtures Clamps for seismic requirements	515, 515A SFCLT
<b>Strip and Track Light Supports</b>	
Independent t-grid support clips for fixtures up to 65 lbs Twist-on t-grid supports for fixtures from 25 lbs to 50 lbs	IDS 2G9, 4G9, 4G8, 4G16
<b>Miscellaneous Supports</b>	
Jack chain and S-hooks T-grid box hangers Independent electrical drop wire/rod securing clip Suspension bar for T-grid and hat channel applications Suspension bars for Lightolier™ Calculite™ Series fixtures	770, 771 512HD EC311 517 Series 520

WARNING – ERICO products shall be installed and used only as indicated in ERICO's product instruction sheets and training materials. Instruction sheets are available at [www.erico.com](http://www.erico.com) and from your ERICO customer service representative. Improper installation, misuse, misapplication or other failure to completely follow ERICO's instructions and warnings may cause product malfunction, property damage, serious bodily injury and death.

UL is a registered trademark of the Underwriters Laboratories, Inc.  
Lightolier is a trademark of Lightolier, Inc.  
Calculite is a trademark of Lightolier, Inc.

Copyright ©2007 ERICO International Corporation. All rights reserved.  
CADDY, CADWELD, CRITEC, ERICO, ERIFLEX, ERITECH, and LENTON are registered trademarks of ERICO International Corporation.

Phone: 800-25-CADDY  
Fax: 800-462-4797  
[www.erico.com](http://www.erico.com)