

SKYE Dimmers and Fan Controls

Single-Pole & 3-Way
600W/VA, 1000W/VA, 8A, 5A, 1.5A
Incandescent, Magnetic Low-Voltage, Fluorescent, Fan Control

Features

- Preset feature allows user to return to previous light setting when turning lights on
- Integrated full-slide control for easy, precise operation
- Preset versions can be wired as Single-Pole or 3-Way
- Green LED softly illuminates when device is off, acting as a night light (Preset versions only)
- Incandescent and Magnetic Low-Voltage offered in single unit version on Preset models
- Neutral is not required for installation of device
- Replaces a standard switch and offers dimmer capabilities
- Square law dimming - perceived dimming level is proportional to the slider position
- Power failure memory
- Radio Frequency Interface filtering is standard on all models
- Electrostatic discharge protection
- Precise color matching
- Quiet Fan Speed Control version has special circuitry to reduce fan motor noise at low speeds
- Compatible with any decorator wallplate or screwless wallplate



SI06P-W

Sleek, functional and economical

SKYE dimmers coordinate perfectly with decorator devices and offer unprecedented features with precise slide control of light levels for numerous lamp types with a wide-range of color choices and easy to wire Single-Pole / 3-Way combo units.



SI06P-V

SKYE Slide Dimmer and Fan Control



Wattage	Lamp Type	Description	Cat. No.	Color
600W	Incandescent	Dimmer, Single-Pole Non-Preset	<input type="checkbox"/> SI061- __	A, B, BK, GY, LA, V, W
600W/VA	Incandescent/MLV	Dimmer, Single-Pole & 3-Way, LED with Preset	<input type="checkbox"/> SI06P- __	A, B, BK, GY, LA, V, W
1000W/VA	Incandescent/MLV	Dimmer, Single-Pole & 3-Way, LED with Preset	<input type="checkbox"/> SI10P- __	A, B, BK, GY, LA, V, W
8A	Fluorescent (Mark 10 [®] , AmbiStar [®] & Tu-Wire [®])	Dimmer, Single-Pole & 3-Way, LED with Preset	<input type="checkbox"/> SF8AP- __	A, B, BK, GY, LA, V, W
8A	Fluorescent (Mark 10 [®])	Dimmer, Single-Pole & 3-Way, LED with Preset, 277V	<input type="checkbox"/> SF8AP7- __	A, B, BK, GY, LA, V, W
1.5A/300W	Quiet 3-speed	Dual Dimmer, Single-Pole, Fan Speed Control	<input type="checkbox"/> SDC15- __	A, B, BK, GY, LA, V, W
1.5A	Quiet 3-speed	Fan Speed Control, Single-Pole & 3-Way with Preset	<input type="checkbox"/> SFS15P- __	A, B, BK, GY, LA, V, W
5A	Fully Variable	Fan Speed Control, Single-Pole	<input type="checkbox"/> SFS5- __	A, B, BK, GY, LA, V, W
5A	Fully Variable	Fan Speed Control, Single-Pole & 3-Way with Preset	<input type="checkbox"/> SFS5P- __	A, B, BK, GY, LA, V, W

To indicate color when ordering, add one of the following suffixes to the Catalog Number:
A (Almond), B (Brown), BK (Black), GY (Gray), LA (Light Almond), V (Ivory), W (White)
Note: All SKYE dimmers and fan speed controls are rated for 120V/AC unless otherwise noted.
For more information see specification information on page 50.

Available Color Options	Load Types	Wiring Types
Almond Brown Black Gray Light Almond Ivory White	Incandescent Fluorescent Halogen Magnetic Low-Voltage 3-Speed and Fully Variable Fan Control	Single-Pole Single-Pole and 3-Way

Accessory Products



Rotary, Toggle and Slide Dimmers

General Product Information	Product Family	TRACE Toggle Dimmer	REACT Rotary Dimmer	SKYE Full-Slide Dimmer	DEVINE Designer Slide Dimmer	ASPIRE Contemporary Slide Dimmer
Catalog Numbers	TI061, TI061L, TI3101, TI3101L	RI061, RI06P, RI06PL, RI101, RFS15, RFS5, RDC15, RDC25	SI061, SI06P, SI10P, SF8AP, SFS15P, SFS5, SFS5P, SDC15	DI06P, DI10P, DE06P, DF8AP, DFS15P	9530, 9531, 9532, 9533, 9538, 9539, 9540, 9541, 9543, 9544, 9568	
Testing & Code Compliance	Regulatory Listings	cULus 6B28 UL1472 NOM ANSI	cULus 6B28 UL1472 NOM ANSI	cULus 6B28 UL1472 NOM ANSI	cULus 6B28 UL1472 NOM ANSI	cULus 6B28 UL 1472 NOM ANSI
Specification: Environmental	Flammability	Flammability meets UL 94 requirements V2 rated	Flammability meets UL 94 requirements V2 rated	Flammability meets UL 94 requirements V2 rated	Flammability meets UL 94 requirements V2 rated	Flammability meets UL 94 requirements V2 rated
	Temperature Rating	Temperature rating: 32 to 104 deg. F (0 to 40C)	Temperature rating: 32 to 104 deg. F (0 to 40C)	Temperature rating: 32 to 104 deg. F (0 to 40C)	Temperature rating: 32 to 104 deg. F (0 to 40C)	Temperature rating: 32 to 104 deg. F (0 to 40C)
Specification: Electrical	Rating	120V/AC 60Hz	120V/AC 60Hz	120V/AC 60Hz	120V/AC 60Hz	120V/AC 60Hz
	Light Intensity Control	Full-range, continuously variable dimming	Full-range, continuously variable dimming	Full-range, continuously variable dimming	Full-range, continuously variable dimming	Full-range, continuously variable dimming
	Dimming Performance	Smooth and continuous Square Law Dimming Curve	Smooth and continuous Square Law Dimming Curve	Smooth and continuous Square Law Dimming Curve	Smooth and continuous Square Law Dimming Curve	Smooth and continuous Square Law Dimming Curve
	Surge Protection	Meets ANSI/IEEE Std. C62.41-1980, tested to withstand voltage surges up to 6000V and current surges of up to 200A without damage	Meets ANSI/IEEE Std. C62.41-1980, tested to withstand voltage surges up to 6000V and current surges of up to 200A without damage	Meets ANSI/IEEE Std. C62.41-1980, tested to withstand voltage surges up to 6000V and current surges of up to 200A without damage	Meets ANSI/IEEE Std. C62.41-1980, tested to withstand voltage surges up to 6000V and current surges of up to 200A without damage	Meets ANSI/IEEE Std. C62.41-1980, tested to withstand voltage surges up to 6000V and current surges of up to 200A without damage
	Radio Frequency Interference	Designed to reduce interference with radio, audio and video equipment	Designed to reduce interference with radio, audio and video equipment	Designed to reduce interference with radio, audio and video equipment	Designed to reduce interference with radio, audio and video equipment	Designed to reduce interference with radio, audio and video equipment
	Power-failure Memory	Light or fan returns to same level prior to power interruption	Light or fan returns to same level prior to power interruption	Light or fan returns to same level prior to power interruption	Light or fan returns to same level prior to power interruption	Light or fan returns to same level prior to power interruption
	Lamp Ratings	Incandescent	Incandescent	Incandescent, Magnetic Low-Voltage, Fluorescent	Incandescent, Magnetic Low-Voltage, Electronic Low-Voltage, Fluorescent	Incandescent, Magnetic Low-Voltage, Electronic Low-Voltage, Fluorescent
	Termination	Wireleads 16 AWG	Wireleads 16 AWG	Side wire / Push Wire	Side wire / Push Wire	Side wire / Push Wire
Specification: Mechanical	Wiring Types	Single-Pole & 3-Way	Single-Pole & 3-Way	Single-Pole & 3-Way	Single-Pole & 3-Way	Single-Pole & 3-Way
	LED Indicators	—	—	Load Status Indicator	—	—
	Air-gap Switch	N/A	N/A	N/A	N/A	N/A
	Top Housing	Poly Carbonate	Poly Carbonate	Poly Carbonate	Poly Carbonate	Poly Carbonate
Material Specification	Bottom Housing	Poly Carbonate	Poly Carbonate	Poly Carbonate	Poly Carbonate	Poly Carbonate
	Strap	Aluminum	Aluminum	Aluminum	Aluminum	Aluminum
	Form Factor	Traditional	Traditional	Decorator	Decorator	Decorator
	Finish	Gloss	Gloss	Gloss	Gloss	Two-tone: Gloss and Matte

Smart Dimmers and Sensors

General Product Information	Product Family	ACCELL Smart Dimmer	ASPIRE Contemporary Smart Dimmer	ASPIRE RF Contemporary Wireless Smart Dimmer	Standard Series Occupancy / Vacancy Sensors	SAVANT Occupancy / Vacancy Sensors
Catalog Numbers	AIM10, AF10, ARD	9534, 9535, 9536, 9537, 9542, 9568	RF9534, RF9534-N, RF9535-N, RF9536, RF9536-N, RF9537-N, RF9542, RF9542-Z	6105, 6107, VSIR04	OS310U, OS310R, VS310U, VS310R, OS106D1*, VS106D1*	
Testing & Code Compliance	Regulatory Listings	cULus 6B28 UL 1472 NOM ANSI	cULus 6B28 UL 1472 NOM ANSI	cULus 6B28 UL 1472 NOM ANSI FCC PART 15, CLASS B Z-Wave Certified	cULus 773A NOM ANSI California Title 24 Compliant	cULus 38DS UL 244A / UL 1472 NOM ANSI California Title 24 Compliant
Specification: Environmental	Flammability	Flammability meets UL 94 requirements V2 rated	Flammability meets UL 94 requirements V2 rated	Flammability meets UL 94 requirements V2 rated	Flammability meets UL 94 requirements V2 rated	Flammability meets UL 94 requirements V2 rated
	Temperature Rating	Temperature rating: 32 to 104 deg. F (0 to 40C)	Temperature rating: 32 to 104 deg. F (0 to 40C)	Temperature rating: 32 to 104 deg. F (0 to 40C)	Temperature rating: 32 to 104 deg. F (0 to 40C)	Temperature rating: 32 to 104 deg. F (0 to 40C)
Specification: Electrical	Rating	120V/AC 60Hz	120V/AC 60Hz	120V/AC 60Hz	120V/AC 60Hz, 1/8 HP	120V/AC 60Hz, 1/2 HP
	Light Intensity Control	Full-range, continuously variable dimming	Full-range, continuously variable dimming	Full-range, continuously variable dimming	N/A	Full-range, continuously variable dimming
	Dimming Performance	Smooth and continuous Square Law Dimming Curve	Smooth and continuous Square Law Dimming Curve	Smooth and continuous Square Law Dimming Curve	N/A	Smooth and continuous Square Law Dimming Curve
	Surge Protection	Meets ANSI/IEEE Std. C62.41-1980, tested to withstand voltage surges up to 6000V and current surges of up to 200A without damage	Meets ANSI/IEEE Std. C62.41-1980, tested to withstand voltage surges up to 6000V and current surges of up to 200A without damage	Meets ANSI/IEEE Std. C62.41-1980, tested to withstand voltage surges up to 6000V and current surges of up to 200A without damage	—	Meets ANSI/IEEE Std. C62.41-1980, tested to withstand voltage surges up to 6000V and current surges of up to 200A without damage
	Radio Frequency Interference	Designed to reduce interference with radio, audio and video equipment	Designed to reduce interference with radio, audio and video equipment	Designed to reduce interference with radio, audio and video equipment	—	Designed to reduce interference with radio, audio and video equipment
	Power-failure Memory	Light returns to same level prior to power interruption	Light returns to same level prior to power interruption	Light returns to same level prior to power interruption	Light returns to same level prior to power interruption	Light returns to same level prior to power interruption
	Lamp Ratings	Incandescent, Magnetic Low-Voltage, Fluorescent	Incandescent, Magnetic Low-Voltage, Electronic Low-Voltage, Fluorescent	Incandescent, Magnetic Low-Voltage, Electronic Low-Voltage, Fluorescent	Incandescent, Magnetic Fluorescent Ballast	SWITCH: Incandescent, Magnetic Low-Voltage, Electronic Low-Voltage, Fluorescent, Compact Fluorescent, LED DIMMER: Incandescent, Magnetic Low-Voltage
	Termination	6" Pre-stripped wireleads 600W - 16 AWG 1000W - 14 AWG	6" Pre-stripped wireleads 600W - 16 AWG 1000W - 14 AWG	6" Pre-stripped wireleads 600W - 16 AWG 1000W - 14 AWG	Wireleads	6" Pre-stripped wireleads 600W - 16 AWG 1000W - 14 AWG
Specification: Mechanical	Wiring Types	Single-Pole and Multi-location	Single-Pole and Multi-location	Single-Pole and Multi-location	Single-Pole & 3-Way	Single-Pole & 3-Way
	LED Indicators	Load Status Indicator, Light Level & Locator	Load Status Indicator, Light Level & Locator	Load Status Indicator, Light Level & Locator	Status	Load Status Indicator, Light Level & Locator
	Air-gap Switch	Meets UL 20 and UL1472 for inclusion of visible, accessible air-gap off switch	Meets UL 20 and UL1472 for inclusion of visible, accessible air-gap off switch	Meets UL 20 and UL1472 for inclusion of visible, accessible air-gap off switch	N/A	Meets UL 20 and UL1472 for inclusion of visible, accessible air-gap off switch
	Top Housing	Poly Carbonate	Poly Carbonate	Poly Carbonate	Poly Carbonate	Poly Carbonate
Material Specification	Bottom Housing	Poly Carbonate	Poly Carbonate	Poly Carbonate	Poly Carbonate	Poly Carbonate
	Strap	Aluminum	Aluminum	Aluminum	Aluminum	Aluminum
	Form Factor	Decorator	Decorator	Decorator	Decorator	Decorator
	Finish	Gloss	Gloss	Two-tone: Gloss and Matte	Gloss	Gloss

*Note: Dimming specification pertain to OS106D1 and VS106D1 sensors only.

ASPIRE RF INC, MLV, ELV
Dimmer w/ Neutral Single-Pole
RF9534-N, RF9535-N, RF9536-N, RF9537-N, RF9542-Z

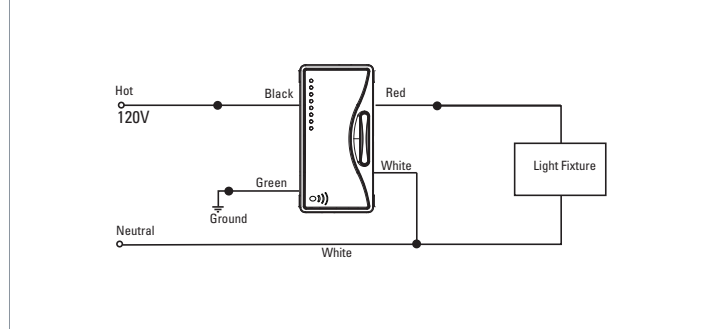

ASPIRE RF INC, MLV, ELV
Dimmer w/ Neutral Multi-location
RF9534-N, RF9535-N, RF9536-N, RF9537-N, RF9542-Z

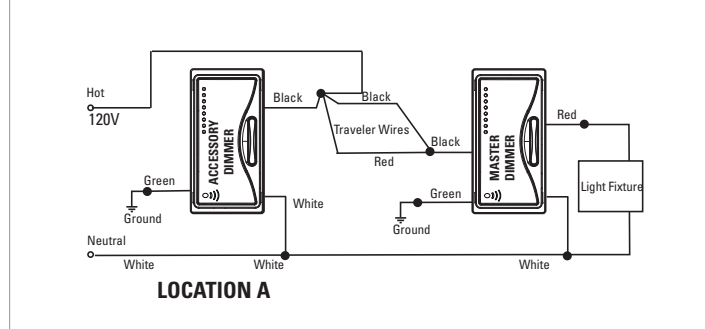

ASPIRE 3 speed & Fully Variable Single-Pole
Slide fan 9544, 9543

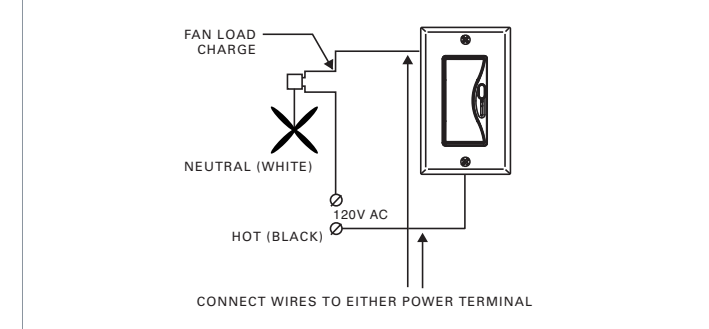

ASPIRE 3 speed & Fully Variable 3-Way
Slide fan 9544, 9543

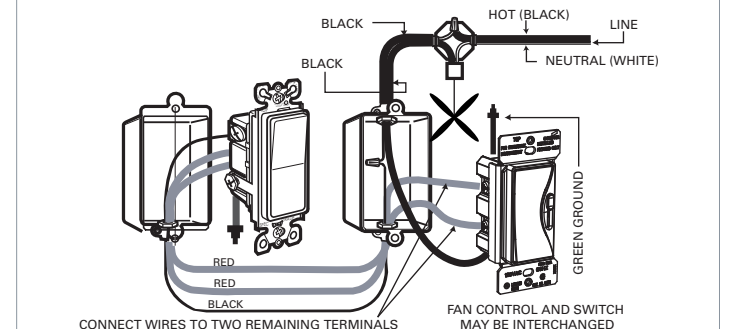

ASPIRE RF, ASPIRE, ACCELL INC, MLV, ELV
Dimmer w/out Neutral Single-Pole
RF9534, RF9536, RF9542, 9534, 9535, 9536, 9537, 9542, AIM10, ARD

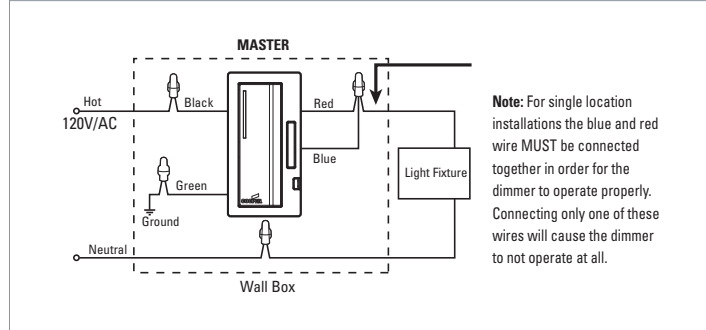

ASPIRE RF, ASPIRE, ACCELL INC, MLV, ELV
Dimmer w/out Neutral Multi-location
RF9534, RF9536, RF9542, 9534, 9535, 9536, 9537, 9542, AIM10, ARD

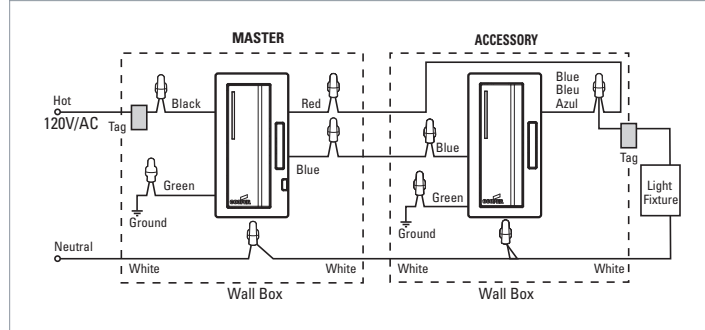

DEVINE INC, MLV, ELV
Dimmer & Fan Single-Pole
DI06P, DI10P, DE06, DFS15P

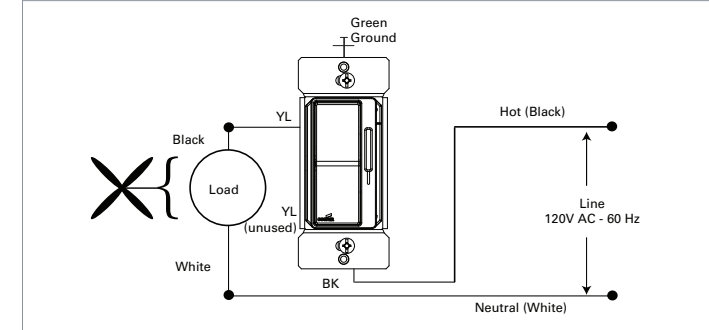

DEVINE INC, MLV, ELV
Dimmer & Fan 3-Way
DI06P, DI10P, DE06, DFS15P

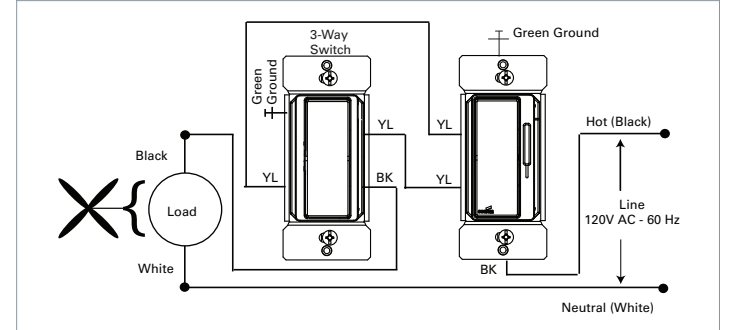

ASPIRE RF, ASPIRE, ACCELL FLR
Dimmer w Neutral Single-Pole
RF9537-N, 9580, AF10

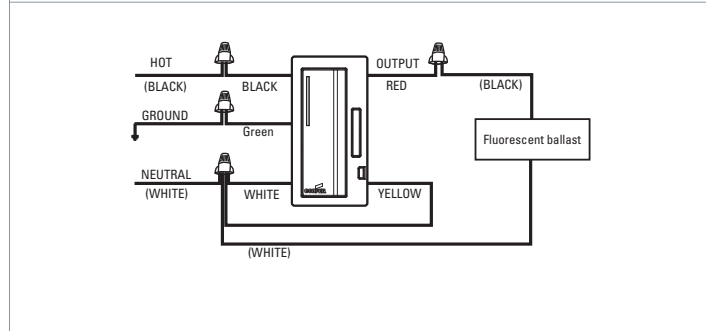

ASPIRE RF, ASPIRE, ACCELL FLR
Dimmer w Neutral Multi-location
RF9537-N, 9580, AF10

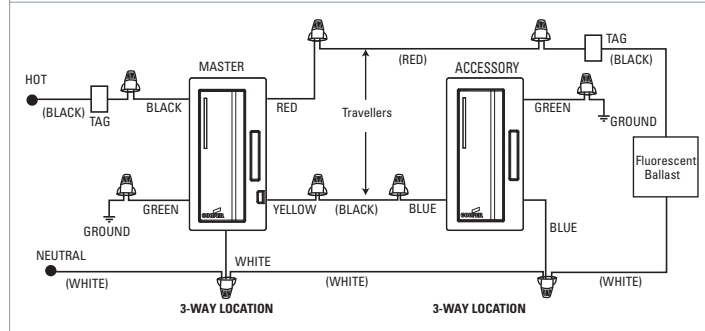

SKYE INC, MLV, ELV
Dimmer & Fan Single-Pole
SI061, SI06P, SI10P, SFS15P, SFS5P, SFS5

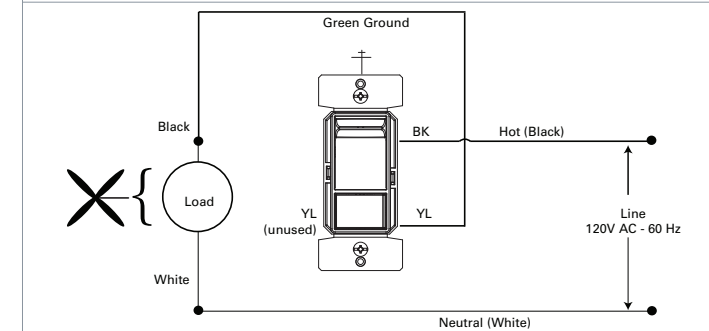

SKYE INC, MLV, ELV
Dimmer & Fan 3-Way
SI06P, SI10P, SFS15P, SFS5P, SFS5

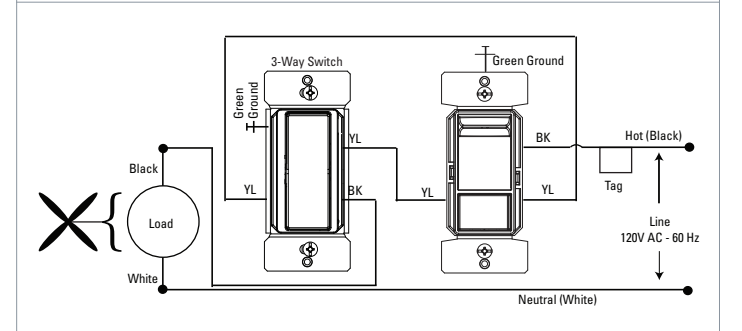

ASPIRE INC, MLV, ELV
Slide Dimmer Single-Pole
9530, 9531, 9532, 9533, 9538, 9539, 9540, 9541

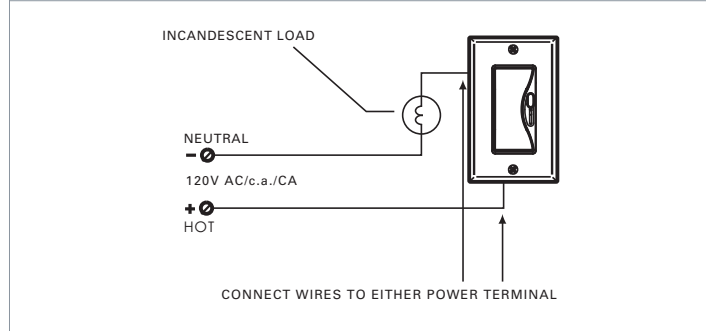

ASPIRE INC, MLV, ELV
Slide Dimmer 3-Way
9530, 9531, 9532, 9533, 9538, 9539, 9540, 9541

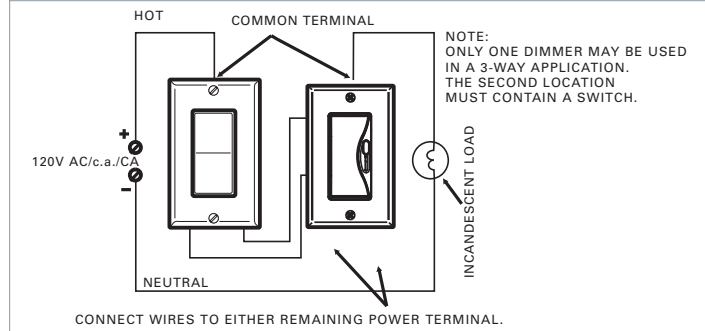

ASPIRE, DEVINE, SKYE FLR
Slide Dimmer Single-Pole
9568, DF8AP, SF8AP

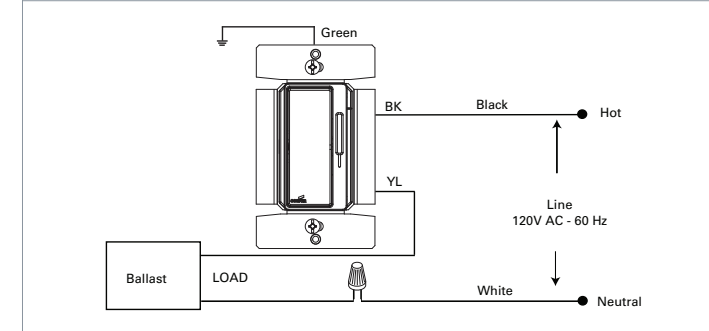

ASPIRE, DEVINE, SKYE FLR
Slide Dimmer 3-Way
9568, DF8AP, SF8AP

