



















**UBIZ ZINSCO®** 

# of Poles	AMP Rating	Catalog Number	UPC
2 Singles	15/15	UBIZ1515 (R3815)	
2 Singles	15/20	UBIZ1520 (R381520)	
2 Singles	20/20	UBIZ2020 (R3820)	
2 Singles	30/30	UBIZ3030 (R3830)	
2	15	UBIZ0215 (R3815)	
2	20	UBIZ0220 (R3820)	
2	25	UBIZ0225 (R3825)	
2	30	UBIZ0230 (R3830)	
2	35	UBIZ0235 (R3835)	
2	40	UBIZ0240 (R3840)	
2	45	UBIZ0245 (R3845)	
2	50	UBIZ0250 (R3850)	
2	60	UBIZ0260 (R3860)	
Sleeve Count: 6 Case Count: 24			
	125	UBIZRBK12	
2	125	UBITBFP1252	
2	150	UBITBFP1502	
2	175	UBITBFP1752	
2	200	UBITBFP2002	

**Thin Series  
Twin Pole-Plug In**

Requires One 3/4" Space  
SWD Rated†  
120VAC  
10,000 AIC  
Corresponds to Zinsco® R Series

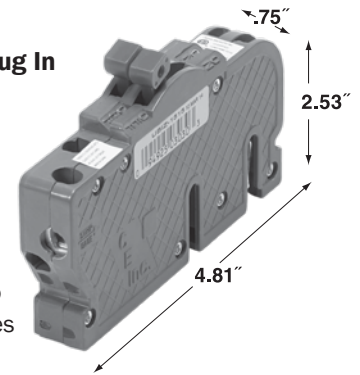

**Thin Series  
Two Pole-Plug In**

Requires One 3/4" Space  
HACR  
120/240VAC  
10,000 AIC  
Corresponds to Zinsco® RC Series

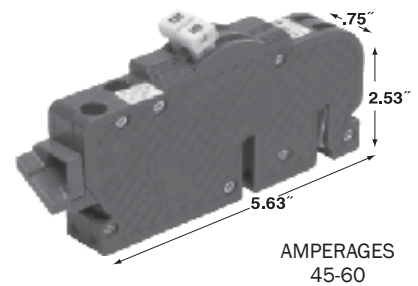
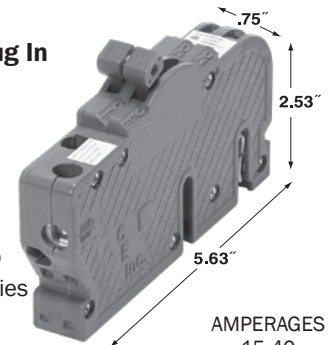

**Zinsco Replacement  
Buss Bar Assembly**

UBIZRBK12

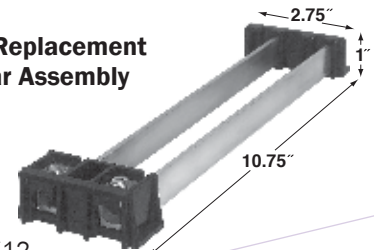

**Zinsco  
Replacement  
Main Breakers  
Type QFP**

UBITBFP's

