

Central Brass

COMPANY

Brecksville, Ohio 44141

Phone: (216) 883-0220 Fax: (440) 526-5745

www.CentralBrass.com

MODEL NO. 0210
LEG TUB FITTING

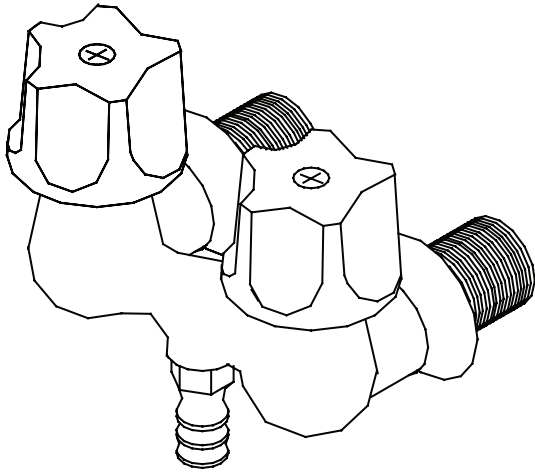

The leg tub fitting has a cast brass body with replaceable seats. The fitting body and spout are polished and chrome plated. The outlet spout is designed for a push on hose connection. The spout fits hose with a 1/2-inch inside diameter. The compression stems are all brass with a double O-Ring seal and rubber seat washer. The canopy handles are zinc die cast with a chrome plated finish.

ASME A112.18.1M

Installation Drawing

