

AC POWERED IONIZATION SMOKE ALARM FOR THE HEARING IMPAIRED

Input: 120V AC 60Hz,
0.053 A Standby, 0.59 A Alarm
Strobe: 177 candela minimum

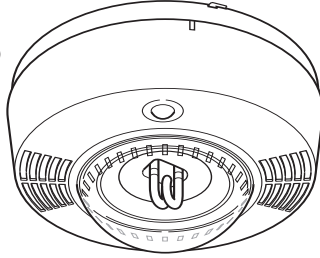

IMPORTANT! PLEASE READ CAREFULLY AND SAVE.

This user's manual contains important information about your Smoke Alarm's operation. If you are installing this Smoke Alarm for use by others, you must leave this manual—or a copy of it—with the end user.

Printed in Mexico
M08-0142-002 K1 08/08

LISTED TO
UL 217 STANDARD
Models 100S, SA100B

TABLE OF CONTENTS

Introduction	1
Fire Safety Tips	1
Before You Install This Smoke Alarm	1
How To Install This Smoke Alarm	2-3
Weekly Testing	3
Regular Maintenance	3
If This Smoke Alarm Sounds	3-4
What To Do In Case Of Fire	4
If You Suspect A Problem	4
Limited Warranty	4
Recommended Placement For Hearing Impaired Smoke Alarms With Integrated Strobe Light	4-5
Locations To Avoid For Smoke Alarms	5
About Smoke Alarms	6
Special Compliance Considerations	6
Limitations Of Smoke Alarms	6

INTRODUCTION

Thank you for choosing First Alert® for your hearing impaired Smoke Alarm with Strobe Light needs. You have purchased a state of the art Smoke Alarm with Integrated Strobe Light designed to provide hearing impaired individuals with a visual warning of a fire. Please take the time to read this manual and make the Smoke Alarm with Integrated Strobe Light an integral part of your family's safety plan.

Key Features of the 100S Smoke Alarm with Integrated Strobe Light:

177 Candela Xenon Light: Powerful 177 candela xenon strobe light provides effective visual warning to awaken hearing impaired residents.

1 Hz Flash Rate: 60 flashes per minute meets ADA, ANSI 117.1, NFPA 72, and UL 1971 requirements for visual signaling devices.

Smoke Alarm: Integrated Dual Ionization smoke alarm.

Meets ADA Requirements: Meets the requirements of the Americans with Disabilities Act (ADA).

© 2008 BRK Brands, Inc. All rights reserved.
Distributed by BRK Brands, Inc.
3901 Liberty Street Road, Aurora, IL 60504-8122
Consumer Affairs: (800) 323-9005
www.brkelectronics.com • www.firstalert.com

All BRK® and First Alert® Smoke Alarms conform to regulatory requirements, including UL217 and are designed to detect particles of combustion. Smoke particles of varying number and size are produced in all fires.

I Ionization technology is generally more sensitive than photoelectric technology at detecting small particles, which tend to be produced in greater amounts by flaming fires, which consume combustible materials rapidly and spread quickly. Sources of these fires may include paper burning in a wastebasket, or a grease fire in the kitchen.

P Photoelectric technology is generally more sensitive than ionization technology at detecting large particles, which tend to be produced in greater amounts by smoldering fires, which may smolder for hours before bursting into flame. Sources of these fires may include cigarettes burning in couches or bedding.

For maximum protection, use both types of Smoke Alarms on each level and in every bedroom of your home.

FIRE SAFETY TIPS

Follow safety rules and prevent hazardous situations: 1) Use smoking materials properly. Never smoke in bed. 2) Keep matches or lighters away from children; 3) Store flammable materials in proper containers; 4) Keep electrical appliances in good condition and don't overload electrical circuits; 5) Keep stoves, barbecue grills, fireplaces and chimneys grease- and debris-free; 6) Never leave anything cooking on the stove unattended; 7) Keep portable heaters and open flames, like candles, away from flammable materials; 8) Don't let rubbish accumulate.

Keep alarms clean, and test them weekly. Replace alarms immediately if they are not working properly. Smoke Alarms that do not work cannot alert you to a fire. Keep at least one working fire extinguisher on every floor, and an additional one in the kitchen. Have fire escape ladders or other reliable means of escape from an upper floor in case stairs are blocked.

BEFORE YOU INSTALL THIS SMOKE ALARM

IMPORTANT! Read "Recommended Locations for Smoke Alarms" and "Locations to Avoid For Smoke Alarms" before beginning. This unit monitors the air, and when smoke reaches its sensing chamber, it alarms. It can give you more time to escape before fire spreads. This unit can ONLY give an early warning of developing fires if it is installed, maintained and located where smoke can reach it, and where all residents can hear it, as described in this manual. This unit will not sense gas, heat, or flame. It cannot prevent or extinguish fires.

Understand The Different Type of Smoke Alarms

Battery powered or electrical? Different Smoke Alarms provide different types of protection. See "About Smoke Alarms" for details.

Know Where To Install Your Smoke Alarms

Fire Safety Professionals recommend at least one Smoke Alarm on every level of your home, in every bedroom, and in every bedroom hallway or separate sleeping area. See "Recommended Locations For Smoke Alarms" and "Locations To Avoid For Smoke Alarms" for details.

Know What Smoke Alarms Can and Can't Do

A Smoke Alarm can help alert you to fire, giving you precious time to escape. It can only sound an alarm once smoke reaches the sensor. See "Limitations of Smoke Alarms" for details.

Check Your Local Building Codes

This Smoke Alarm is designed to be used in a typical single-family home. It alone will not meet requirements for boarding houses, apartment buildings, hotels or motels. See "Special Compliance Considerations" for details.

⚠ DANGER!

ELECTRICAL SHOCK HAZARD. Turn off power to the area where you will install this Smoke Alarm at the circuit breaker or fuse box before beginning installation. Failure to turn off the power before installation may result in serious electrical shock, injury or death.

⚠ WARNING!

- Installation of this Smoke Alarm must conform to the electrical codes in your area; Articles 210 and 300.3 (B) of NFPA 70 (NEC), NFPA 72, NFPA 101; SBC (SBCCI); UBC (ICBO); NBC (BOCA); OTFDC (CABO), and any other local or building codes that may apply. Wiring and installation must be performed by a licensed electrician. Failure to follow these guidelines may result in injury or property damage.
- This Smoke Alarm must be powered by a 24-hour, 120VAC 60Hz circuit. Be sure the circuit cannot be turned off by a switch, dimmer, or ground fault circuit interrupter. Failure to connect this Smoke Alarm to a 24-hour circuit may prevent it from providing constant protection.
- It is possible an electrical fire could occur on the circuit powering this Smoke Alarm. If this happened, power to the unit could be cut off and it may fail to alarm. Some safety experts recommend wiring warning devices like this unit on separate circuits from other appliances, since these circuits are not as likely to be overloaded. Other safety experts recommend wiring these units on the same circuits as appliances so it is more readily apparent if the circuit fails. Whichever circuit you choose, it is recommended you also install battery powered units as back-ups in case of fire on the circuit powering the AC powered units.
- Never disconnect the power from an AC powered Smoke Alarm to stop an unwanted alarm. Doing so will disable the unit and remove your protection. In the case of a true unwanted alarm open a window or fan the smoke away from the unit. The alarm will reset automatically when it returns to normal operation. Never remove the batteries from a battery operated Smoke Alarm to stop an unwanted alarm (caused by cooking smoke, etc.). Instead open a window or fan the smoke away. The Smoke Alarm will reset automatically.

⚠ CAUTION!

- Connect this Smoke Alarm ONLY to other compatible units. See "How To Install This Smoke Alarm" for details. Do not connect it to any other type of alarm or auxiliary device. Connecting anything else to this unit may damage it or prevent it from operating properly.

HOW TO INSTALL THIS SMOKE ALARM

This Smoke Alarm is designed to be mounted on any standard wiring junction box to a 4-inch (10 cm) diagonal size, on either the ceiling or wall (if allowed by local codes). Read "Recommended Locations For Smoke Alarms" and "Locations to Avoid For Smoke Alarms" before you begin installation.

Tools you will need: Standard Flathead screwdriver.

THE PARTS OF THIS SMOKE ALARM



The Mounting Bracket

Installs onto the junction box. It has a variety of screw slots to fit most boxes. If a junction box is not already in place, install one. To remove the mounting bracket from the Smoke Alarm base, hold the Smoke Alarm base firmly and twist mounting bracket counterclockwise.

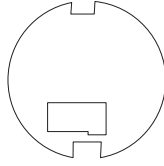

The Foam Gasket

The foam gasket prevents air currents from coming through the junction box and blowing smoke away from the sensor. It must be installed to comply with UL standards. When installing the foam gasket, line up the cut-outs with the power input block on the Smoke Alarm.

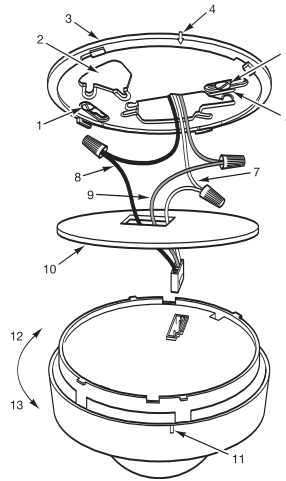

Parts of the Smoke Alarm

- | | |
|----|----------------------------------|
| 1 | Mounting slot and screw (1 of 2) |
| 2 | Junction box |
| 3 | Mounting bracket |
| 4 | Mounting Bracket Alignment Arrow |
| 5 | Mounting slot and screw (1 of 2) |
| 6 | Wire strip gauge |
| 7 | Neutral (white) AC wire |
| 8 | Hot (black) AC wire |
| 9 | Interconnect wire |
| 10 | Foam gasket |
| 11 | Alignment Tab On Alarm |
| 12 | Turn to attach to bracket |
| 13 | Turn to remove from bracket |

The Power Connector

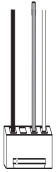

The power connector plugs into a power input block on the Smoke Alarm and supplies it AC power.

- Black wire is "hot."
- White wire is neutral.
- Orange wire is used for interconnect.

If you need to remove the power connector, turn POWER OFF first. To remove the power connector, insert a flat screwdriver blade between the power connector and the security tab inside the power input block. Gently pry back the tab and pull the connector free.

⚠WARNING! Make sure the Alarm is not receiving excessively noisy power. Examples of noisy power could be major appliances on the same circuit, power from a generator or solar power, light dimmer on the same circuit or mounted near fluorescent lighting. Excessively noisy power may cause damage to your Alarm.

FOLLOW THESE INSTALLATION STEPS

The basic installation of this Smoke Alarm is the similar whether you want to install one Smoke Alarm, or interconnect more than one Smoke Alarm. If you are interconnecting more than one Smoke Alarm, you **MUST** read "Special Requirements For Interconnected Smoke Alarms" below before you begin installation.

⚠DANGER!

ELECTRICAL SHOCK HAZARD! Turn off power before starting installation!

1. Remove the mounting bracket from the base. Install the mounting bracket to the junction box
2. Set the foam gasket against the back of the Smoke Alarm.
3. Using wire nuts, connect the power connector to the household wiring.

STAND-ALONE ALARM ONLY:

- Connect the white wire on the power connector to the neutral wire in the junction box.
- Connect the black wire on the power connector to the hot wire in the junction box.
- Tuck the orange wire inside the junction box. It is used for interconnect only.

INTERCONNECTED UNITS ONLY:

Strip off about 1/2" (12 mm) of the plastic coating on the orange wire on the power connector.

- Connect the white wire on the power connector to the neutral wire in the junction box.
- Connect the black wire on the power connector to the hot wire in the junction box.
- Connect the orange wire on the power connector to the interconnect wire in the junction box. Repeat for each unit you are interconnecting. Never connect the hot or neutral wires in the junction box to the orange interconnect wire.

4. Plug the power connector into the back of the Smoke Alarm.

5. Line up the alignment tab on the base with the alignment tab on the mounting bracket. Turn the Smoke Alarm clockwise (right) until you hear the unit snap into place.
6. Check all connections.

⚠WARNING!

Improper wiring of the power connector or the wiring leading to the power connector will cause damage to the Alarm and may lead to a non-functioning Alarm.

STAND-ALONE ALARM ONLY:

- If you are only installing one Smoke Alarm, restore power to the junction box.

INTERCONNECTED UNITS ONLY:

- If you are interconnecting multiple Smoke Alarms, repeat steps 1-6 for each Smoke Alarm in the series. When you are finished, restore power to the junction box.

⚠DANGER!

ELECTRICAL SHOCK HAZARD! Do not restore power until all smoke alarms are completely installed. Restoring power before installation is complete may result in serious electrical shock, injury or death.

7. Make sure the Smoke Alarm is receiving AC power. Under normal operation, the green power indicator light will shine continuously. If the power indicator light does not light, **TURN OFF POWER TO THE JUNCTION BOX** and recheck all connections. If all connections are correct and the power indicator still does not light when you restore the power, the unit should be replaced immediately.
8. Test the Smoke Alarm. Press and hold the test button on the cover of the unit until the alarm sounds (the unit may continue to alarm for a few seconds after you release the button). **During testing, you will hear a loud, repeating horn pattern: 3 beeps, pause, 3 beeps, pause. In an interconnected series, you must test each Smoke Alarm individually.**

IMPORTANT!

If any Smoke Alarm does not alarm, **TURN OFF POWER** and recheck connections. If any Smoke Alarm still does not alarm when you test it after restoring power, replace it immediately.

FOLLOW THESE INSTALLATION STEPS, Continued

SPECIAL REQUIREMENTS FOR INTERCONNECTED SMOKE ALARMS

⚠ WARNING!

- Failure to meet any of the requirements for interconnecting Smoke Alarms could damage the units, and cause them to malfunction, removing your protection.
- AC and AC/DC Smoke Alarms can be interconnected. Under AC power, all units will alarm when one senses smoke. When power is interrupted, only the AC/DC units in the series will continue to send and receive signals. AC powered Smoke Alarms will not operate.

Interconnected units can provide earlier warning of fire than stand-alone units, especially if a fire starts in a remote area of the home. If any Smoke Alarm in the series senses smoke, all units will alarm. This Smoke Alarm can be interconnected with **First Alert®** Smoke Alarm Models SA4120, SA4121B, SA100B, SC9120B and **BRK Electronics®** Smoke Alarm Models 100S, 4120 series, 9120 series, 7010 series; **BRK Electronics®** Heat Alarm Models HD6135F, HD6135FB; Smoke/CO Alarm Model SC6120B.

IMPORTANT!

Interconnect units within a single family residence only. Otherwise all households will experience unwanted alarms when you test any unit in the series. Interconnected units will only work if they are wired to compatible units and all requirements are met.

Interconnected units must meet ALL of the following requirements:

- A maximum of 18 units total may be interconnected (Maximum of 12 Smoke Alarms).
- The same fuse or circuit breaker must power all interconnected Smoke Alarms.
- The total length of wire interconnecting the units should be less than 1000 feet (305 meters). This type of wire is commonly available at Hardware and Electrical Supply stores.
- All wiring must conform to all local electrical codes and the National Electrical Code (NFPA 70). Refer to NFPA 72 and/or your local building code for further connection requirements.

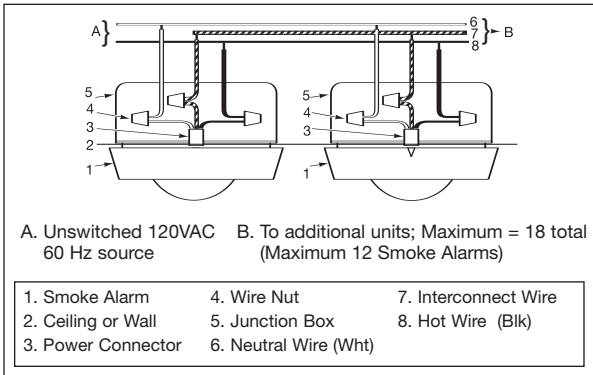

WEEKLY TESTING

⚠ WARNING!

- NEVER use an open flame of any kind to test this Smoke Alarm. You might accidentally damage or set fire to your home. The built-in test switch accurately tests the Smoke Alarm's operation as required by Underwriters Laboratories, Inc. (UL).
- Do not look directly at or touch the lens while the strobe light is flashing. Doing so can hurt your eyes or burn your fingers. If the strobe light does not flash during testing, the Smoke Alarm should be replaced.

⚠ CAUTION!

Do not stand too close to the unit when the alarm is sounding. It is loud to wake you in an emergency. Exposure to the horn at close range may harm your hearing.

It is important to test this Smoke Alarm every week to make sure it is working properly. Using the test button is the recommended way to test this Smoke Alarm. Press and hold the test button on the cover until the alarm sounds (it may continue alarming briefly after you release the button). If the Smoke Alarm does not sound make sure it is receiving power and test it again. If it still does not alarm, replace it immediately. During testing, you will hear a loud, repeating horn pattern: 3 beeps, pause, 3 beeps, pause.

The strobe light should flash every time you test the Smoke Alarm.

IMPORTANT!

When testing Smoke Alarms in an interconnected series, you must test each unit individually. Make sure all units alarm when each one is tested. The strobe lights on all units should flash as each individual Smoke Alarm is tested.

REGULAR MAINTENANCE

This unit has been designed to be as maintenance free as possible, but there are a few simple things you must do to keep it working properly.

- Test it at least once a week.
- Clean the Smoke Alarm at least once a month; gently vacuum off any dust using your household vacuum's soft brush attachment, and test the Smoke Alarm after cleaning. Never use water, cleaners or solvents since they may damage the unit.
- If the Smoke Alarm becomes contaminated by excessive dirt, dust and/or grime, and cannot be cleaned to avoid unwanted alarms, replace the unit immediately.
- Relocate the unit if it sounds frequent unwanted alarms. See "Locations to Avoid For Smoke Alarms" for details.

⚠ CAUTION!

- If the strobe light is loose or broken, the entire unit should be replaced immediately. Never remove the strobe light lens for any reason. Doing so can permanently damage the unit and will void your warranty.
- Do not paint over the unit. Paint may clog the openings to the sensing chamber and prevent the unit from operating properly.

IF THIS SMOKE ALARM SOUNDS

RESPONDING TO AN ALARM

During an alarm, you will hear a loud, repeating horn pattern: 3 beeps, pause, 3 beeps, pause and the strobe light will be flashing.

⚠ WARNING!

- If the unit alarms and you are not testing the unit, it is warning you of a potentially dangerous situation that requires your immediate attention. NEVER ignore any alarm. Ignoring the alarm may result in injury or death. If the unit alarms and you are not absolutely certain of the source of the smoke, get everyone out of the house immediately.

Continued...

RESPONDING TO AN ALARM, Continued

- Never disconnect the AC power to quiet an unwanted alarm. Disconnecting the power disables the alarm so it cannot sense smoke. This will remove your protection. Instead open a window or fan the smoke away from the unit. The alarm will reset automatically

⚠ DANGER!

- **ELECTRICAL SHOCK HAZARD:** Attempting to disconnect the power connector from the unit when the power is on may result in electrical shock, serious injury or death.

IMPORTANT!

When an interconnected system of AC powered units is in alarm, the alarm indicator light on the unit(s) that triggered the alarm will blink rapidly. It will remain OFF on any remaining units.

If the unit alarms and you are not absolutely certain of the source of the smoke, get everyone out of the house immediately. Stay calm and follow your family escape plan. Stay as low to the ground as possible, and cover your mouth with a damp cloth. Never open a door before testing it to see if it is hot. Call the Fire Department from outside, and give them your address then name. Read "What To Do In Case Of Fire" for more information.

If the unit alarms and you are certain that the source of smoke is not a fire—cooking smoke or an extremely dusty furnace, for example—open a nearby window or door and fan the smoke away from the unit. This will silence the alarm, and once the smoke clears the unit will reset automatically.

WHAT TO DO IN CASE OF FIRE

- Don't panic, stay calm. Follow your family escape plan.
- Get out of the house as quickly as possible. Don't stop to get dressed or collect anything.
- Feel doors with the back of your hand before opening them. If a door is cool, open it slowly. Don't open a hot door. Keep doors and windows closed, unless you must escape through them.
- Cover your nose and mouth with a cloth (preferably wet). Take short, shallow breaths.
- Meet at your planned meeting place outside your home, and do a head count to make sure everybody got out safely.
- Call the Fire Department as soon as possible from outside. Give your address, then your name.
- Never go back inside a burning building for any reason.
- Contact your Fire Department for ideas on making your home safer.

⚠ WARNING!

Alarms have various limitations. See "Limitations of Smoke Alarms" for details.

IF YOU SUSPECT A PROBLEM

Smoke Alarms may not operate properly because of a build-up of dirt, dust or grease on the Smoke Alarm cover, or installation in an improper location. Alarms with battery back-up may not work because of dead, missing or weak batteries. Clean the Smoke Alarm as described in "Regular Maintenance"—and install a fresh battery if unit has battery back-up—then test the Smoke Alarm again. If it fails to test properly when you use the test button, or if the problem persists, replace the Smoke Alarm immediately.

- If you experience frequent non-emergency alarms (like those caused by cooking smoke), try relocating the Smoke Alarm.
- If the alarm sounds when no smoke is visible, try cleaning or relocating the Smoke Alarm. The cover may be dirty.
- If the alarm does not sound during testing, make sure it is receiving AC power from the household current.

⚠ CAUTION!

If the strobe light lens is loose or broken, the entire unit should be replaced immediately. Never remove the strobe light lens for any reason. Doing so can permanently damage the unit and will void your warranty.

⚠ WARNING!

Always discharge the branch circuit before servicing an AC or AC/DC Smoke Alarm. First, turn off the AC power at the circuit breaker or fuse box. Next, remove the battery from Smoke Alarms with battery back-up. Finally, press and hold the test button for 5-10 seconds to discharge the branch circuit.

Do not try fixing the alarm yourself – this will void your warranty!

If the Smoke Alarm is still not operating properly, and it is still under warranty, please see "How to Obtain Warranty Service" in the Limited Warranty below.

LIMITED WARRANTY

BRK Brands, Inc., ("BRK") the maker of BRK® brand and First Alert® brand products, warrants that for a period of ten years from the date of purchase, this product will be free from defects in material and workmanship. BRK, at its option, will repair or replace this product or any component of the product found to be defective during the warranty period. Replacement will be made with a new or remanufactured product or component. If the product is no longer available, replacement may be made with a similar product of equal or greater value. This is your exclusive warranty.

This warranty is valid for the original retail purchaser from the date of initial retail purchase and is not transferable. Keep the original sales receipt. Proof of purchase is required to obtain warranty performance. BRK dealers, service centers, or retail stores selling BRK products do not have the right to alter, modify or any way change the terms and conditions of this warranty.

This warranty does not cover normal wear of parts or damage resulting from any of the following: negligent use or misuse of the product, use on improper voltage or current, use contrary to the operating instructions, disassembly, repair or alteration by anyone other than BRK or an authorized service center. Further, the warranty does not cover Acts of God, such as fire, flood, hurricanes and tornadoes or any batteries that are included with this unit.

BRK shall not be liable for any incidental or consequential damages caused by the breach of any express or implied warranty. Except to the extent prohibited by applicable law, any implied warranty of merchantability or fitness for a particular purpose is limited in duration to the duration of the above warranty. Some states, provinces or jurisdictions do not allow the exclusion or limitation of incidental or consequential damages or limitations on how long an implied warranty lasts, so the above limitations or exclusion may not apply to you. This warranty gives you specific legal rights, and you may also have other rights that vary from state to state or province to province.

How to Obtain Warranty Service

Service: If service is required, do not return the product to your retailer. In order to obtain warranty service, contact the Consumer Affairs Division at 1-800-323-9005, 7:30 AM - 5:00 PM Central Standard Time, Monday through Friday. To assist us in serving you, please have the model number and date of purchase available when calling.

For Warranty Service return to:

BRK Brands, Inc., 25 Spur Drive, El Paso, TX 79906

RECOMMENDED PLACEMENT FOR HEARING IMPAIRED SMOKE ALARMS WITH INTEGRATED STROBE LIGHT

Smoke Alarms with Integrated Strobe lights intended for the hearing impaired should be located in the bedroom where a hearing impaired person sleeps. Additional alarms should be located in any room where a hearing impaired person may be present and need to be notified of a smoke danger.

According to NFPA 72, for wall mounting, a 177 candela strobe light must be used in a sleeping area when mounting height of lens is less than 24 inches (61 cm) from the ceiling. A Smoke Alarm with an integrated Strobe light must be placed in accordance with the Smoke Alarm placement recommendations.

For Wall Mounting the alarm should be between 4 inches and 12 inches (102 mm and 305 mm) from ceiling to avoid the "dead air space". For Ceiling Mounting the alarm should be placed at least 4 inches (102 mm) from wall or corner (see "Locations to Avoid for Smoke Alarms" below). In addition, for wall or ceiling mounting, the unit must be located within 16 linear feet (4.8 meters) from top of lens to the pillow (See diagram).

RECOMMENDED PLACEMENT

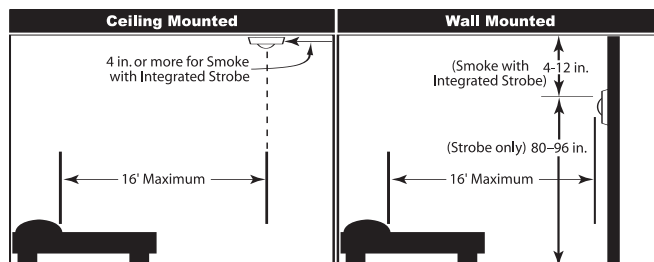

STROBE LIGHT OUTPUT FOR WALL & CEILING MOUNTING

The intensity of the strobe light gradually lessens as the angle increases. In other words, the light is brightest directly in front of the strobe light and is progressively less bright to either side. As required by Underwriters Laboratories Inc. (UL), the following illustrations show how the strobe light is dispersed. Use them to help you choose where to locate units for the hearing impaired.

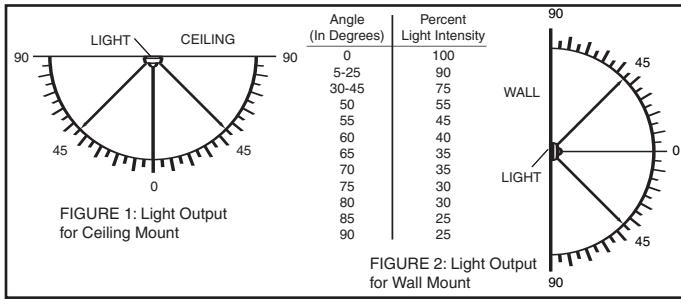

PHOTOSENSITIVE EPILEPSY AND STROBE FLASH RATES

Individuals who are susceptible to photosensitive epilepsy might have an increased probability for seizures with multiple strobe lights flashing asynchronously. The frequency or speed of flashing light that is most likely to cause seizures varies from person to person. Generally, flashing lights most likely to trigger seizures are between the frequency of 5 to 30 flashes per second (Hertz). This strobe light flashes at about 1 flash per second.

Under the Americans with Disabilities Act, most workplaces and places serving the public, including theaters, restaurants, and recreation areas, are required to have fire alarms, which flash as well as ring so that people who cannot hear or cannot hear well will know that there is an emergency.

INSTALLING SMOKE ALARMS IN MOBILE HOMES

For minimum security install one Smoke Alarm as close to each sleeping area as possible. For more security, put one in each room. Many older mobile homes (especially those built before 1978) have little or no insulation. If your mobile home is not well insulated, or if you are unsure of the amount of insulation, it is important to install units on inside walls only. Smoke Alarms should be installed where temperatures normally remain between 40° F (4° C) and 100° F (38° C).

IMPORTANT!

This equipment should be installed in accordance with NFPA (National Fire Protection Association) 72 and 101. National Fire Protection Association, One Batterymarch Park, Quincy, MA 02269-9101. **Additional local building and regulatory codes may apply in your area. Always check compliance requirements before beginning any installation.**

AGENCY PLACEMENT RECOMMENDATIONS

NFPA 72 (National Fire Code)

Smoke Alarms shall be installed in each separate sleeping room, outside each sleeping area in the immediate vicinity of the bedrooms and on each additional story of the family living unit, including basements and excluding crawl spaces and unfinished attics.

In new construction, Alarms shall be so arranged that operation of any one Alarm shall cause the operation of all Alarms within the dwelling.

Smoke Detection-Are More Smoke Alarms Desirable? The required number of Smoke Alarms might not provide reliable early warning protection for those areas separated by a door from the areas protected by the required Smoke Alarms. For this reason, it is recommended that the householder consider the use of additional Smoke Alarms for those areas for increased protection. The additional areas include the basement, bedrooms, dining room, furnace room, utility room, and hallways not protected by the required Smoke Alarms. The installation of Smoke Alarms in kitchens, attics (finished or unfinished), or garages is not normally recommended, as these locations occasionally experience conditions that can result in improper operation.

California State Fire Marshal (CSFM)

Early warning detection is best achieved by the installation of fire detection equipment in all rooms and areas of the household as follows: A Smoke Alarm installed in each separate sleeping area (in the vicinity, but outside bedrooms), and Heat or Smoke Alarms in the living rooms, dining rooms, bedrooms, kitchens, hallways, finished attics, furnace rooms, closets, utility and storage rooms, basements, and attached garages.

LOCATIONS TO AVOID FOR SMOKE ALARMS

For best performance, it is recommended you **AVOID** installing Smoke Alarms in these areas:

- Where combustion particles are produced. Combustion particles form when something burns. Areas to avoid include poorly ventilated kitchens, garages, and furnace rooms. Keep units at least 20 feet (6 meters) from the sources of combustion particles (stove, furnace, water heater, space heater) if possible. In areas where a 20-foot (6 m) distance is not possible – in modular, mobile, or smaller homes, for example – it is recommended the Smoke Alarm be placed as far from these fuel-burning sources as possible. The placement recommendations are intended to keep these Alarms at a reasonable distance from a fuel-burning source, and thus reduce “unwanted” alarms. Unwanted alarms can occur if a Smoke Alarm is placed directly next to a fuel-burning source. Ventilate these areas as much as possible.
- In air streams near kitchens. Air currents can draw cooking smoke into the sensing chamber of a Smoke Alarm near the kitchen.
- In very damp, humid or steamy areas, or directly near bathrooms with showers. Keep units at least 10 feet (3 meters) away from showers, saunas, dishwashers, etc.
- Where the temperatures are regularly below 40° F (4° C) or above 100° F (38° C), including unheated buildings, outdoor rooms, porches, or unfinished attics or basements.
- In very dusty, dirty, or greasy areas. Do not install a Smoke Alarm directly over the stove or range. Keep laundry room Smoke Alarms free of dust or lint.
- Near fresh air vents, ceiling fans, or in very drafty areas. Drafts can blow smoke away from the unit, preventing it from reaching the sensing chamber.
- In insect infested areas. Insects can clog openings to the sensing chamber and cause unwanted alarms.
- Less than 12 inches (305mm) away from fluorescent lights. Electrical “noise” can interfere with the sensor.
- In “dead air” spaces. “Dead air” spaces may prevent smoke from reaching the Smoke Alarm.

Avoiding Dead Air Spaces

“Dead air” spaces may prevent smoke from reaching the Smoke Alarm. To avoid dead air spaces, follow the installation recommendations below.

On ceilings, install Smoke Alarms as close to the center of the ceiling as possible. If this is not possible, install the Smoke Alarm at least 4 inches (102 mm) from the wall or corner.

For wall mounting (if allowed by building codes), the top edge of Smoke Alarms should be placed between 4 inches (102 mm) and 12 inches (305 mm) from the wall/ceiling line, below typical “dead air” spaces.

On a peaked, gabled, or cathedral ceiling, install the first Smoke Alarm within 3 feet (0.9 meters) of the peak of the ceiling, measured horizontally. Additional Smoke Alarms may be required depending on the length, angle, etc. of the ceiling’s slope. Refer to NFPA 72 for details on requirements for sloped or peaked ceilings.

ABOUT SMOKE ALARMS

Battery (DC) operated Smoke Alarms: Provide protection even when electricity fails, provided the batteries are fresh and correctly installed. Units are easy to install, and do not require professional installation. However, they do not provide interconnected functionality.

AC powered Smoke Alarms: Can be interconnected so if one unit senses smoke, all units alarm. They do not operate if electricity fails. AC Smoke Alarms must be installed by a qualified electrician.

AC/DC powered Smoke Alarms: (AC with battery back-up): Can be interconnected so if one unit senses smoke, all units alarm. They will operate if electricity fails, provided the batteries are fresh and correctly installed. AC/DC Smoke Alarms must be installed by a qualified electrician.

Wireless Interconnected Alarms: Offer the same interconnected functionality as with hardwired alarms, without wires. Units are easy to install and do not require professional installation. They provide protection even when electricity fails, provided the batteries are fresh and correctly installed.

Smoke Alarms for Solar or Wind Energy users and battery backup power systems: AC powered Smoke Alarms should only be operated with true or pure sine wave inverters. Operating this Smoke Alarm with most battery-powered UPS (uninterruptible power supply) products or square wave or “quasi sine wave” inverters **will damage the Alarm**. If you are not sure about your inverter or UPS type, please consult with the manufacturer to verify.

Smoke Alarms for the hearing impaired: Special purpose Smoke Alarms should be installed for the hearing impaired. They include a visual alarm and an audible alarm horn, and meet the requirements of the Americans With Disabilities Act. These units can be interconnected so if one unit senses smoke, all units alarm. They do not operate if electricity fails. Units must be installed by a qualified electrician. **This Smoke Alarm is an AC powered unit that has an 85 decibel alarm and a 177 candela strobe light, which flashes rapidly when the unit is in alarm. This unit is specially designed to wake hearing impaired persons. It features an 85 dB alarm plus a brilliant 177 candela strobe light that flashes rapidly when the unit senses smoke.**

Smoke alarms are not to be used with detector guards unless the combination has been evaluated and found suitable for that purpose.

All these Smoke Alarms are designed to provide early warning of fires if located, installed and cared for as described in the user's manual, and if smoke reaches them. If you are unsure which type of unit to install, refer to NFPA (National Fire Protection Association) 72 (National Fire Alarm Code) and NFPA 101 (Life Safety Code), National Fire Protection Association, One Batterymarch Park, Quincy, MA 02269-9101. Also check your local building codes which may also require specific units in new construction or in different areas of the home.

SPECIAL COMPLIANCE CONSIDERATIONS

⚠WARNING!

This Smoke Alarm alone is not a suitable substitute for complete fire detection systems in places housing many people—like apartment buildings, condominiums, hotels, motels, dormitories, hospitals, long-term health care facilities, nursing homes, day care facilities, or group homes of any kind—even if they were once single-family homes. It is not a suitable substitute for complete fire detection systems in warehouses, industrial facilities, commercial buildings, and special-purpose non-residential buildings which require special fire detection and alarm systems. Depending on the building codes in your area, this Smoke Alarm may be used to provide additional protection in these facilities.

The following information applies to all four building types below: In new construction, most building codes require the use of AC or AC/DC powered Smoke Alarms only. In existing construction, AC, AC/DC, or DC powered Smoke Alarms can be used as specified by local building codes. Refer to NFPA 101 (Life Safety Code) or NFPA 72 (National Fire Alarm Code), local building codes, or consult your Fire Department for detailed fire protection requirements in buildings not defined as “households.”

- 1. Single-Family Residence:** Single family home, townhouse. It is recommended Smoke Alarms be installed on every level of the home, in every bedroom, and in each bedroom hallway.
- 2. Multi-Family or Mixed Occupant Residence:** Apartment building, condominium. This Smoke Alarm is suitable for use in individual apartments or condos, provided a primary fire detection system already exists to meet fire detection requirements in common areas like lobbies, hallways, or porches. Using this Smoke Alarm in common areas may not provide sufficient warning to all residents or meet local fire protection ordinances/regulations.
- 3. Institutions:** Hospitals, day care facilities, long-term health care facilities. This Smoke Alarm is suitable for use in individual patient sleeping/resident rooms, provided a primary fire detection system already exists to meet fire detection requirements in common areas like lobbies, hallways, or porches. Using this Smoke Alarm in common areas may not provide sufficient warning to all residents or meet local fire protection ordinances/regulations.
- 4. Hotels and Motels:** Also boarding houses and dormitories. This Smoke Alarm is suitable for use inside individual sleeping/resident rooms, provided a primary fire detection system already exists to meet fire detection requirements in common areas like lobbies, hallways, or porches. Using this Smoke Alarm in common areas may not provide sufficient warning to all residents or meet local fire protection ordinances/regulations.

LIMITATIONS OF SMOKE ALARMS

Smoke Alarms have played a key role in reducing deaths resulting from home fires worldwide. However, like any warning device, Smoke Alarms can only work if they are properly located, installed, and maintained, and if smoke reaches them. They are not foolproof.

Smoke alarms may not waken all individuals. Practice the escape plan at least twice a year, making sure that everyone is involved – from kids to grandparents. Allow children to master fire escape planning and practice before holding a fire drill at night when they are sleeping. If children or others do not readily waken to the sound of the smoke alarm, or if there are infants or family members with mobility limitations, make sure that someone is assigned to assist them in fire drill and in the event of an emergency. It is recommended that you hold a fire drill while family members are sleeping in order to determine their response to the sound of the smoke alarm while sleeping and to determine whether they may need assistance in the event of an emergency.

Smoke Alarms cannot work without power. Battery operated units cannot work if the batteries are missing, disconnected or dead, if the wrong type of batteries are used, or if the batteries are not installed correctly. AC units cannot work if the AC power is cut off for any reason (open fuse or circuit breaker, failure along a power line or at a power station, electrical fire that burns the electrical wires, etc.). If you are concerned about the limitations of battery or AC power, install both types of units.

Smoke Alarms cannot detect fires if the smoke does not reach them. Smoke from fires in chimneys or walls, on roofs, or on the other side of closed doors may not reach the sensing chamber and set off the alarm. That is why one unit should be installed inside each bedroom or sleeping area—especially if bedroom or sleeping area doors are closed at night—and in the hallway between them.

Smoke Alarms may not detect fire on another floor or area of the home. For example, a stand-alone unit on the second floor may not detect smoke from a basement fire until the fire spreads. This may not give you enough time to escape safely. That is why recommended minimum protection is at least one unit in every sleeping area, and every bedroom on every level of your home. Even with a unit on every floor, stand-alone units may not provide as much protection as interconnected units, especially if the fire starts in a remote area. Some safety experts recommend installing interconnected AC powered units with battery back-up (see “About Smoke Alarms”) or professional fire detection systems, so if one unit senses smoke, all units alarm. Interconnected units may provide earlier warning than stand-alone units since all units alarm when one detects smoke.

Smoke Alarms may not be heard. Though the alarm horn in this unit meets or exceeds current standards, it may not be heard if: 1) the unit is located outside a closed or partially closed door, 2) residents recently consumed alcohol or drugs, 3) the alarm is drowned out by noise from stereo, TV, traffic, air conditioner or other appliances, 4) residents are hearing impaired or sound sleepers. Special purpose units, like those with visual and audible alarms, should be installed for hearing impaired residents.

Smoke Alarms may not have time to alarm before the fire itself causes damage, injury, or death, since smoke from some fires may not reach the unit immediately. Examples of this include persons smoking in bed, children playing with matches, or fires caused by violent explosions resulting from escaping gas.

Smoke Alarms are not foolproof. Like any electronic device, Smoke Alarms are made of components that can wear out or fail at any time. You must test the unit weekly to ensure your continued protection. Smoke Alarms cannot prevent or extinguish fires. They are not a substitute for property or life insurance.

Smoke Alarms have a limited life. The unit should be replaced immediately if it is not operating properly. You should always replace a Smoke Alarm after 10 years from date of purchase. Write the purchase date on the space provided on back of unit.

BRK® is a registered trademark of BRK Brands, Inc.
First Alert® is a registered trademark of the First Alert Trust.

Printed in Mexico M08-0142-002 K1 08/08