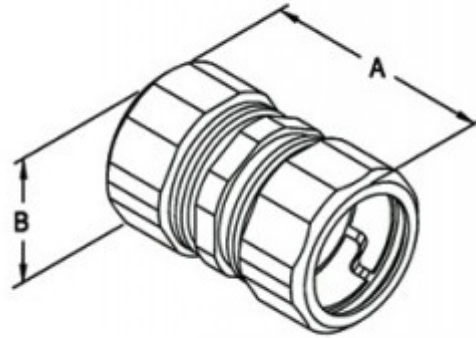

3/4" Malleable Iron Rigid Compression Coupling

Rigid compression type coupling used to join Rigid or IMC conduit together.

[Download Photo](#)[Download Drawing](#)

Product details

Catalog Number:	3101
UPC Number:	781747031013
Primary Materials:	Malleable Iron
Finish:	Zinc Plated
Trade Size:	3/4"
Unit Quantity:	25
Standard Package Quantity:	100

Dimensions

Trade Size:	3/4"
Dimensions A:	1-7/8
Dimensions B:	1/2
Dimensions C:	1-5/8

Certifications & Codes

Federal Specification Number: A-A-50553

UL File Number: E9391

UNSPSC: 39131707

Nema Standard: FB-1

UL Standard: UL-514B