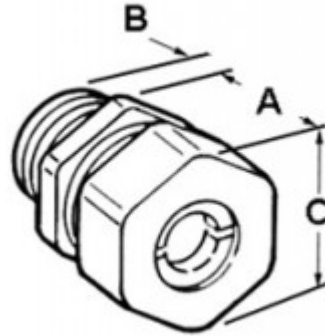

Connector, Cord Grip, Straight, Zinc Die Cast, Size K.O. 1/2 Inch, Cord Range .250 Inch - .375 Inch

Straight connector for use with portable cord. Provides liquid tight and watertight protection. Tapered (NPT) threads with gasket and locknut. Supplemental UL listing: Type 4 watertight.

[Download Photo](#)[Download Drawing](#)

Product details

Catalog Number:	770-42
UPC Number:	781747770424
Primary Materials:	Zinc Die Cast
Finish:	Ball burnished, mirror smooth
Trade Size:	1/2"
Unit Quantity:	25
Standard Package Quantity:	100

Dimensions

Trade Size:	1/2"
Dimensions A:	1
Dimensions B:	9/16
Dimensions C:	1-3/16

Certifications & Codes

UL File Number: E11259**CSA File Number:** LR39354**UNSPSC:** 39121431**Nema Standard:** FB-1**UL Standard:** UL-514B**Country Of Manufacture:** USA