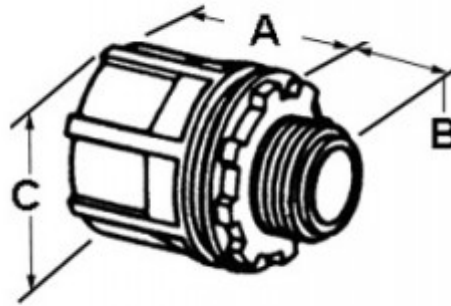

Threaded Hub, Zinc Die Cast, Size 1 1/4 Inch

To secure threaded rigid service entrance conduit to box or enclosure. Insulated throat rated 105 degree C. UL listed Type 4 - Watertight. Suitable for Aluminum and Steel Rigid Conduit

[Download Photo](#)[Download Drawing](#)

Product details

Catalog Number:	154-DC
UPC Number:	781747091543
Primary Materials:	Zinc Die Cast
Finish:	Ball burnished, mirror smooth
Trade Size:	1-1/4"
Unit Quantity:	5
Standard Package Quantity:	25

Dimensions

Trade Size:	1-1/4"
Dimensions A:	1-3/16
Dimensions B:	3/4
Dimensions C:	1-15/16

Certifications & Codes

Federal Specification Number: A-A-50553**UL File Number:** E9391**UNSPSC:** 39121311**Nema Standard:** FB-1**UL Standard:** UL-514B