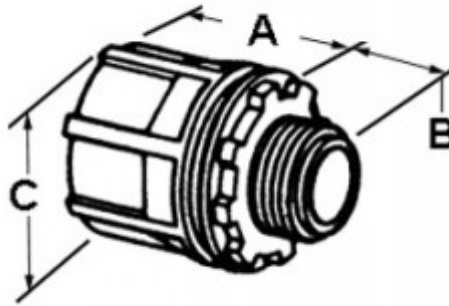

Threaded Hub, Zinc Die Cast, Size 1/2 Inch

To secure threaded rigid service entrance conduit to box or enclosure. Insulated throat rated 105 degree C. Suitable for Aluminum and Steel Rigid Conduit. UL listed

[Download Photo](#)[Download Drawing](#)

Product details

Catalog Number:	151-DC
UPC Number:	781747091512
Primary Materials:	Zinc Die Cast
Finish:	Ball burnished, mirror smooth
Trade Size:	1/2"
Unit Quantity:	25
Standard Package Quantity:	100

Dimensions

Trade Size:	1/2"
Dimensions A:	13/16
Dimensions B:	9/16
Dimensions C:	1-1/8

Certifications & Codes

Federal Specification Number: A-A-50553**UL File Number:** E9391**UNSPSC:** 39121311**Nema Standard:** FB-1**UL Standard:** UL-514B