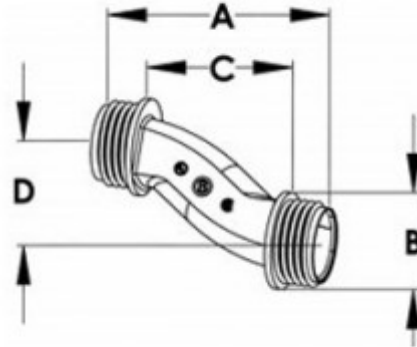

Nipple, Offset, Zinc Die Cast, Size 3/4 Inch

Used to offset the axis of raceway 3/4 ". Dry Location Only.

[Download Photo](#)
[Download Drawing](#)

Product details

Catalog Number:	1521-DC
UPC Number:	781747915214
Primary Materials:	Zinc Die Cast
Finish:	Ball burnished, mirror smooth
Trade Size:	3/4"
Unit Quantity:	10
Standard Package Quantity:	100

Dimensions

Trade Size:	3/4"
Dimensions A:	2.75
Dimensions B:	1.312
Dimensions C:	1.625
Dimensions D:	0.75

Certifications & Codes

Federal Specification Number: A-A-50553

UL File Number: E9391

CSA File Number: LR39354

UNSPSC: 39131718

Nema Standard: FB-1

UL Standard: UL-514B

Country Of Manufacture: USA