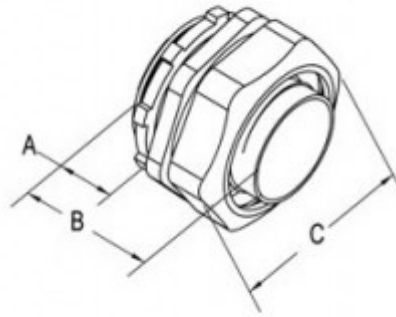

Connector, Liquid Tight, Zinc Die Cast, Size 3/4 Inch

Straight connector for use with metallic and non-metallic "Type B" liquid tight conduit. Liquidtight connectors are suitable for use in Class I, Div 2; Class II, Div 1 and 2; and Class III, Div 1 and 2 hazardous locations.

[Download Photo](#)[Download Drawing](#)

Product details

Catalog Number:	431-LT2
UPC Number:	781747154316
Primary Materials:	Zinc Die Cast
Finish:	Ball burnished, mirror smooth
Trade Size:	3/4"
Unit Quantity:	10
Standard Package Quantity:	50

Dimensions

Trade Size:	3/4"
Dimensions A:	7/8
Dimensions B:	7/8
Dimensions C:	1-3/4 Point to Point

Certifications & Codes

Federal Specification Number: A-A-50552**UL File Number:** E9391**CSA File Number:** LR39354**UNSPSC:** 39121420**Nema Standard:** FB-1**UL Standard:** UL-514B