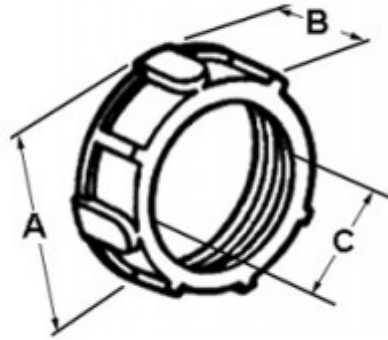

## Bushing, Plastic - 105 Degrees C, Size 3 1/2 Inch

Used with locknut to terminate threaded rigid and IMC to box, or used with connector to prevent damage to wire insulation. Rated 105 degree C.

[Download Photo](#)[Download Drawing](#)

### Product details

<b>Catalog Number:</b>	329
<b>UPC Number:</b>	781747003294
<b>Primary Materials:</b>	Plastic
<b>Finish:</b>	Plain
<b>Trade Size:</b>	3-1/2"
<b>Standard Package Quantity:</b>	25

### Dimensions

<b>Trade Size:</b>	3-1/2"
<b>Dimensions A:</b>	4-5/16
<b>Dimensions B:</b>	3/4
<b>Dimensions C:</b>	3-3/8

### Certifications & Codes

**Federal Specification Number:** A-A-50553**UL File Number:** E9391**CSA File Number:** LR39354**UNSPSC:** 39121312**Nema Standard:** FB-1**UL Standard:** UL-514B**Country Of Manufacture:** USA