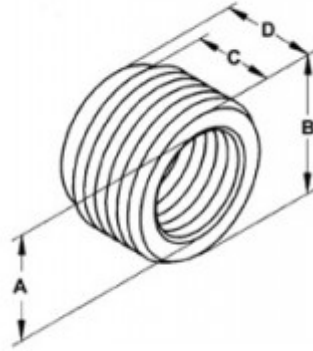

Bushing, Reducing, Steel, Size 2 - 1/2 Inch

Used to reduce the size of internal female threads. 1/2" thru 2" steel, 2 1/2" thru 4" malleable iron.

[Download Photo](#)[Download Drawing](#)

Product details

Catalog Number:	1171
UPC Number:	781747011718
Primary Materials:	Steel
Finish:	Zinc electro-plate
Trade Size:	2-1/2"
Unit Quantity:	10
Standard Package Quantity:	50

Dimensions

Trade Size:	2-1/2"
Dimensions A:	5/8
Dimensions B:	2-3/16
Dimensions C:	5/8
Dimensions D:	7/8

Certifications & Codes

UL File Number: E9391

CSA File Number: LR39354

UNSPSC: 39121312

UL Standard: UL-514B