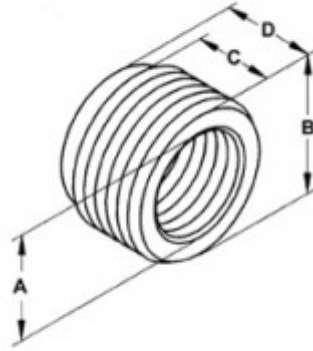

Bushing, Reducing, Steel, Size 1 1/4 - 1 Inch

Used to reduce the size of internal female threads. 1/2" thru 2" steel, 2 1/2" thru 4" malleable iron.

[Download Photo](#)[Download Drawing](#)

Product details

Catalog Number:	1166
UPC Number:	781747011664
Primary Materials:	Steel
Finish:	Zinc electro-plate
Trade Size:	1-1/4" - 1"
Unit Quantity:	25
Standard Package Quantity:	100

Dimensions

Trade Size:	1-1/4" - 1"
Dimensions A:	1
Dimensions B:	1-1/2
Dimensions C:	1/2
Dimensions D:	3/4

Certifications & Codes

UL File Number: E9391

CSA File Number: LR39354

UNSPSC: 39121312

UL Standard: UL-514B