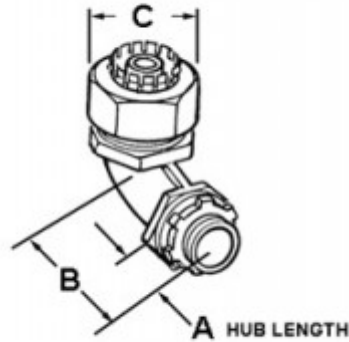

Connector, Liquid Tight, Cast Zinc, Size 3/8 Inch

90 Degree connector for use with metallic and nonmetallic "Type B" liquid tight conduit. Liquidtight connectors are suitable for use in Class I, Div 2; Class II, Div 1 and 2; and Class III, Div 1 and 2 hazardous locations.

[Download Photo](#)[Download Drawing](#)

Product details

Catalog Number:	469-LT2
UPC Number:	781747154699
Finish:	Zinc electro-plate
Trade Size:	3/8"
Unit Quantity:	25
Standard Package Quantity:	100

Dimensions

Trade Size:	3/8"
Dimensions A:	9/16
Dimensions B:	1-1/2
Dimensions C:	1-1/2

Certifications & Codes

Federal Specification Number: A-A-50552

UL File Number: E9391

CSA File Number: LR39354

UNSPSC: 39121420

Nema Standard: FB-1

UL Standard: UL-514B