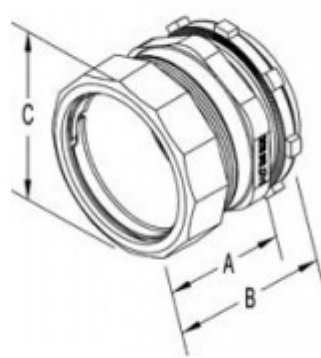

Connector, Compression, Zinc Die Cast, Size 4 Inch

Used to join steel EMT to box or enclosure. Concrete-tight. 2 1/2" thru 4" suitable for use with Steel EMT. 2-1/2" through 4" also listed for use with Steel and Aluminum Rigid Conduit. CSA Listed Raintight/For Use in Wet Locations in Canada Only

[Download Photo](#)[Download Drawing](#)

Product details

Catalog Number:	259-DC2
UPC Number:	781747152596
Primary Materials:	Zinc Die Cast
Finish:	Ball burnished, mirror smooth
Trade Size:	4"
Standard Package Quantity:	6

Dimensions

Trade Size:	4"
Dimensions A:	2.75
Dimensions B:	3.75
Dimensions C:	5.25

Certifications & Codes

Federal Specification Number: A-A-50553**UL File Number:** E24001**CSA File Number:** LR39354**UNSPSC:** 39121434**Nema Standard:** FB-1**UL Standard:** UL-514B**Country Of Manufacture:** USA