

Gangable Plastic Boxes

Build the box you need with these nail and screw-on gangable plastic boxes for new & retrofit work.

FEATURES AND BENEFITS

- Use a screwdriver to disassemble or separate the parts. Add or remove the center section(s), then snap the pieces back together...fast and easy!
- Great-looking installation of multiple gang boxes
- Nail-on style for new construction or screw-on style for new or old construction
- For old work, mounting wings hold the box securely against the wall

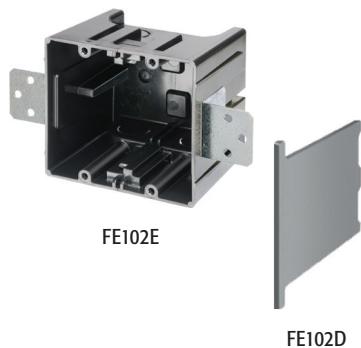

FE102E

FE102D

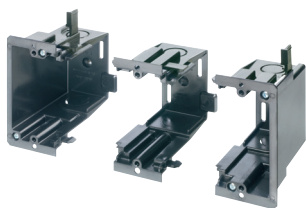

FER102 screw-on with one FER102C center



FES102 screw-on with one FE102C center

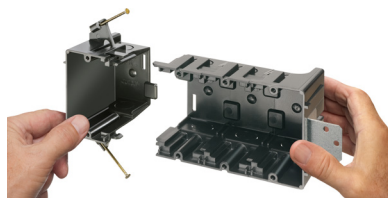

FEN102 nail-on with two FE102C centers

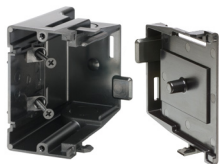

FES102 screw-on with FE101 plate
Snap together to create single gang box.



FEN102 nail-on with five FE102C centers

CATALOG NUMBER	UPC/DCI/NAED MFG #018997	DESCRIPTION	UNIT PKG	STD PKG	DIM A	DIM B	DIM C
FE102C	01582	Each adds one gang Center section for FEN102 and FES102	10	10	3.688	3.500	2.686
FE102D	01586	Optional Voltage Divider	25	25	3.476	3.335	.125
FE102E	01585	2-Gang (includes 2 brackets) Mounts with brackets for new nonstruction	10	10	4.250	3.500	2.236
FEN102	01580	2-Gang (includes 1 bracket) Nail-on for new construction	1	10	6.002	3.500	2.044
FER102	01583	2-Gang w/ mounting wing screws for old work	1	10	4.258	3.500	2.097
FER102C	01584	Each adds one gang Center section for old work use with FER102	10	10	3.615	3.500	1.812
FES102	01581	2-Gang (includes 1 bracket) Screw-on for retrofit or new construction	1	10	3.688	3.500	2.044
FE101	06930	Single-gang plate Converts any box to single-gang	10	10	3.688	3.500	2.754

PATENTED.

Scan For Video



UL Listed
up to
10 GANGS
(two end sections
plus up to 8 center
sections)

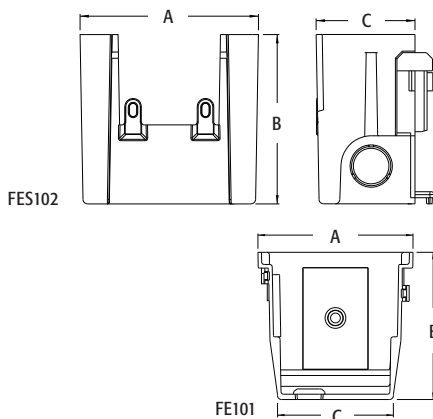

E170558

INSTALLATION INSTRUCTIONS

Assemble

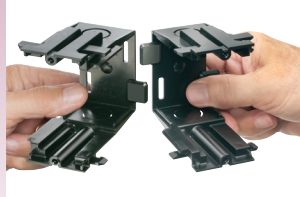

Each section adds one gang to the box. Snap the pieces together to make your desired box.
From three to ten gangs.

Disassemble

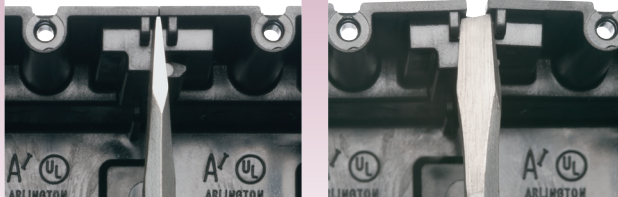

To disassemble or separate the parts, insert a screwdriver between the tabs at the top of the box (on each side) as shown above, and twist.